

Data Sheet | Item Number: 765-4102/100-000

8-Port IO-Link Master Class B; Profinet; DC 24 V / 2.0 A; 8xM12 connection; WideLine

<https://www.wago.com/765-4102/100-000>

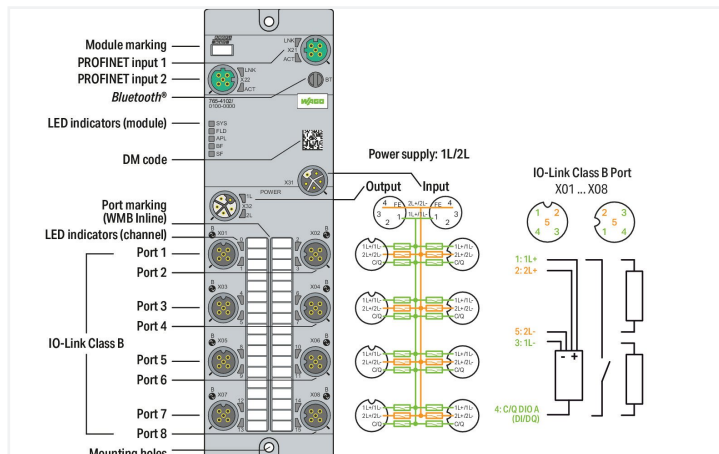

Einsatzbereich:

Dezentrale Verarbeitung von Digitalen- und IO-Link-Signalen

Das Gerät dient zur Erfassung und Ansteuerung von IO-Link-fähigen digitalen Feldgeräten, z.B. von Sensoren, Aktoren und Hubs, die von einer übergeordneten Steuerung empfangen bzw. angesteuert werden. Das Gerät ist als Class B Master ausgelegt, und bietet 8 IO-Link Ports bzw. 8 digitale Ein-/Ausgänge.

IO-Link:

Das Gerät verfügt über mehrere IO-Link-Kommunikationsschnittstellen für die Zusammenarbeit mit IO-Link Devices.

Die IO-Link-Schnittstelle ermöglicht den direkten Zugriff auf die Prozess- und Diagnosedaten und bietet die Möglichkeit, die Parameter der angeschlossenen Geräte während des Betriebs einzustellen.

Die IODD kann auch über den IODDfinder <https://ioddfinder.io-link.com> heruntergeladen werden.

Technical data

Fieldbus

Communication	PROFINET PROFINET IO device; 2-port switch, LLDP, MRP, SNMP
Connection technology: communication/fieldbus	2 x D-coded M12; 4-pole
Interface standard	10BASE-T/100BASE-TX; potential-free
Autonegotiation; autocrossover	Yes
PROFINET IO features	PROFINET IO device; 2-port switch, LLDP, MRP, SNMP

Device functions

Parameter	Input filter Output current Temperature
Diagnostics	Undervoltage; overcurrent; overload; overtemperature
Device functions	Bluetooth® OPC UA server
Visualization	Android/iOS app Web server

IO-Link master

IO-Link master classification	Class B; V1.1 specification
Port mode	IO-Link: autoconfig, manual, tool-based DI DO
Cycle time	400 µs (min.)
Operating mode	IO-Link master, DI or DO (adjustable for pin 4 per port); Supply voltage 2L (fixed for pin 2 per port)

IO-Link ports

Number of digital inputs	8
Number of digital outputs	8
Connection technology: inputs/outputs	8 x A-coded M12; 5-pole
Signal type (voltage)	24 VDC
Input characteristic	high-side switching Type 3, per IEC 61131-2
Input filter	0.2 ... 20 ms
Output current (per channel)	2 A (typ.) for DO
Supply current per port	1L (pin 1): 1 A for IO-Link; 4 A (max.) for DIO; 2L (pin 2): 4 A (max.)

Supply (module)

Connection technology: supply	2 x L-coded M12; 5-pole
Supply voltage	24 VDC (18 ... 31.2 V); 1L/2L
Current consumption (max.)	16000 mA
Current consumption (note)	per supply line; overload- and short-circuit-protected
Reverse voltage protection	Yes

Physical data

Width	60 mm / 2.362 inches
Height	30 mm / 1.181 inches
Depth	210 mm / 8.268 inches

Mechanical data

Weight	610 g
Conformity marking	CE

Environmental requirements

Ambient temperature (operation)	-25 ... +70 °C
Ambient temperature (storage)	-40 ... +80 °C
Protection type	IP67
Protection class	III per EN 61140, IEC 61140, VDE 0140-1
Operating altitude	0 ... 2000 m / 0 ... 6562 ft
Pollution degree	3 (EN 60664-1)
Overvoltage category	II (EN 60664-1)
Relative humidity (without condensation)	95 %
Vibration resistance	5g per IEC 60068-2-6
Shock resistance	Short-term: 50g/11 ms/half-sine per IEC 60068-2-27; Long-term: 30g/6 ms/half-sine per IEC 60068-2-29
EMC immunity to interference	per EN 61000-6-2
EMC emission of interference	per EN 61000-6-4

Commercial data

ETIM 8.0	EC001601
ETIM 7.0	EC001601
PU (SPU)	1 pcs
Packaging type	Box
Country of origin	DE
GTIN	4055143949798
Customs tariff number	85371098990

Environmental Product Compliance

CAS-No.	7439-92-1
REACH Candidate List Substance	Lead
RoHS Compliance Status	Compliant,With Exemption
RoHS Exemption	6(c) 7(a) 7(c)-I
SCIP notification number (Austria)	6d1ad9c1-f95d-4c14-8249-159e28231916
SCIP notification number (Belgium)	5388b1d3-f9db-4c51-b872-077bae18af07
SCIP notification number (Bulgaria)	fca0a80a-38f1-4a64-9ef2-10822ae109fa
SCIP notification number (Czech Republic)	6bee4663-25bd-40e2-8b1c-9fe19ae56536
SCIP notification number (Denmark)	e38dc57d-6ab8-4cfb-a008-376fe963f05d
SCIP notification number (Finland)	a055f1db-fe5d-4c80-a685-dcbf2ff4b043

Environmental Product Compliance

SCIP notification number (France)	07c4e187-d4cc-4538-921b-27e445e47d66
SCIP notification number (Germany)	d0385843-01ac-4b79-b70b-10a201bea192
SCIP notification number (Hungary)	8a954bcc-af15-4622-9259-db1ff4812ce8
SCIP notification number (Italy)	6855686e-55a2-47c5-a76b-df412b67c4b6
SCIP notification number (Netherlands)	7283711d-0d9c-49f4-b90d-57207f3c2a2d
SCIP notification number (Poland)	59ed2081-7e91-4b91-a03f-43941b9fd638
SCIP notification number (Romania)	fe084e57-3f78-40c9-9f2a-2002df7edd86
SCIP notification number (Sweden)	80da011c-4c17-4690-a3c1-06fa6eb066e5

Approvals / Certificates

General approvals



Approval	Standard	Certificate Name
KC National Radio Research Agency	Article 58-2, Clause 3	KC R-R-W43-FB765

Downloads

Environmental Product Compliance

Compliance Search
Environmental Product Compliance 765-4102/100-000 ↓

Documentation

Manual
Product Manual 8-Port IO-Link Master Class B; Profinet V 2.2.0 19.07.2022 pdf 9247.37 KB ↓

System Description
WAGO I/O System Field; General Product Information pdf 1009.23 KB ↓

Instruction Leaflet
I/O System Field package insert 15.12.2021 pdf 1083.98 KB ↓

CAD/CAE-Data



CAD data
2D/3D Models 765-4102/100-000 ↓

CAE data
EPLAN Data Portal 765-4102/100-000 ↓

ZUKEN Portal 765-4102/100-000 ↓

Libraries

Device Description File

750-916; GSD files of version 2.x for PROFINET/ series 750/753, 765, 767 and 852	3.0 15.01.2023	zip 2582.40 KB	
Gerätebeschreibungsdateien 765-41xx, 765-11xx, PROFINET	V1_1_0_22	zip 27.85 KB	

1 Compatible Products

1.1 Required Accessories

1.1.1 Cover

1.1.1.1 Cover



[Item No.: 756-8103](#)

M12 protective cap; for unused plugs

[Item No.: 756-8102](#)

M12 protective cap; for unused sockets

1.1.2 Marking

1.1.2.1 Marker



[Item No.: 2009-115](#)

WMB-Inline; for Smart Printer; 1500 pieces on roll; stretchable 5 - 5.2 mm; plain; snap-on type; white

1.1.2.2 Marking strip



[Item No.: 2009-110](#)

Marking strips; for Smart Printer; on reel; not stretchable; plain; snap-on type; white

1.1.3 Tool

1.1.3.1 Assembly tool



[Item No.: 206-701](#)

Torque wrench M8 and M12; Assembly kit

1.2 Optional Accessories

1.2.1 Cables and connectors

1.2.1.1 Adapter



[Item No.: 756-9503/040-000](#)
Accessories; 4-pole

[Item No.: 756-9504/040-000](#)
Accessories; 4-pole

1.2.1.2 Configurable connector



[Item No.: 756-9701/050-000](#)
Fitted pluggable connector; 5-pole, shielded; M12 plug, straight; IDC technology

[Item No.: 756-9711/050-000](#)
Fitted pluggable connector; 5-pole, shielded; M12 socket, straight; IDC technology

[Item No.: 756-9205/050-000](#)
Fitted pluggable connector; 5-pole; M12 plug, right angle; Spring

[Item No.: 756-9202/050-000](#)
Fitted pluggable connector; 5-pole; M12 plug, straight, A-coded; Spring

1.2.1.3 Configurable shielded connector



[Item No.: 756-9501/040-000](#)
Accessories; M12 plug, right angle; 4-pole

[Item No.: 756-9501/060-000](#)
Fitted pluggable connector; 4-pole, shielded; M12 plug, straight, D-coded; Spring

1.2.1.4 Distribution connector



[Item No.: 756-9301/050-000](#)
Accessories; 5-pole

1.2.1.5 ETHERNET/PROFINET cable



[Item No.: 756-1202/060-100](#)
ETHERNET cable; M12D plug; angled; 4-pole; Length: 10 m

[Item No.: 756-1202/060-020](#)
ETHERNET cable; M12D plug; angled; 4-pole; Length: 2 m

[Item No.: 756-1202/060-200](#)
ETHERNET cable; M12D plug; angled; 4-pole; Length: 20 m

[Item No.: 756-1202/060-050](#)
ETHERNET cable; M12D plug; angled; 4-pole; Length: 5 m



[Item No.: 756-1204/060-010](#)
ETHERNET cable; M12D plug; angled; M12D plug; angled; 4-pole; Length: 1 m

[Item No.: 756-1204/060-100](#)
ETHERNET cable; M12D plug; angled; M12D plug; angled; 4-pole; Length: 10 m

[Item No.: 756-1204/060-020](#)
ETHERNET cable; M12D plug; angled; M12D plug; angled; 4-pole; Length: 2 m

[Item No.: 756-1204/060-200](#)
ETHERNET cable; M12D plug; angled; M12D plug; angled; 4-pole; Length: 20 m



[Item No.: 756-1204/060-030](#)
ETHERNET cable; M12D plug; angled; M12D plug; angled; 4-pole; Length: 3 m

[Item No.: 756-1204/060-050](#)
ETHERNET cable; M12D plug; angled; M12D plug; angled; 4-pole; Length: 5 m

[Item No.: 756-1201/060-100](#)
ETHERNET cable; M12D plug; straight; 4-pole; Length: 10 m

[Item No.: 756-1201/060-020](#)
ETHERNET cable; M12D plug; straight; 4-pole; Length: 2 m



[Item No.: 756-1201/060-200](#)
ETHERNET cable; M12D plug; straight; 4-pole; Length: 20 m

[Item No.: 756-1201/060-050](#)
ETHERNET cable; M12D plug; straight; 4-pole; Length: 5 m

[Item No.: 756-1203/060-100](#)
ETHERNET cable; M12D plug; straight; M12D plug; straight; 4-pole; Length: 10 m





































[Item No.: 756-1203/060-020](#)
ETHERNET cable; M12D plug; straight; M12D plug; straight; 4-pole; Length: 2 m















[Item No.: 756-1203/060-200](#)
ETHERNET cable; M12D plug; straight; M12D plug; straight; 4-pole; Length: 20 m

[Item No.: 756-1203/060-050](#)
ETHERNET cable; M12D plug; straight; M12D plug; straight; 4-pole; Length: 5 m

1.2.1.6 Power cable

 Item No.: 756-3504/050-100 Power cable; M12L plug; angled; 5-pole; Length: 10 m	 Item No.: 756-3504/050-150 Power cable; M12L plug; angled; 5-pole; Length: 15 m	 Item No.: 756-3504/050-020 Power cable; M12L plug; angled; 5-pole; Length: 2 m	 Item No.: 756-3504/050-050 Power cable; M12L plug; angled; 5-pole; Length: 5 m
 Item No.: 756-3504/050-075 Power cable; M12L plug; angled; 5-pole; Length: 7.5 m	 Item No.: 756-3503/050-100 Power cable; M12L plug; straight; 5-pole; Length: 10 m	 Item No.: 756-3503/050-150 Power cable; M12L plug; straight; 5-pole; Length: 15 m	 Item No.: 756-3503/050-020 Power cable; M12L plug; straight; 5-pole; Length: 2 m
 Item No.: 756-3503/050-050 Power cable; M12L plug; straight; 5-pole; Length: 5 m	 Item No.: 756-3503/050-075 Power cable; M12L plug; straight; 5-pole; Length: 7.5 m	 Item No.: 756-3502/050-100 Power cable; M12L socket; angled; 5-pole; Length: 10 m	 Item No.: 756-3502/050-150 Power cable; M12L socket; angled; 5-pole; Length: 15 m
 Item No.: 756-3502/050-020 Power cable; M12L socket; angled; 5-pole; Length: 2 m	 Item No.: 756-3502/050-050 Power cable; M12L socket; angled; 5-pole; Length: 5 m	 Item No.: 756-3502/050-075 Power cable; M12L socket; angled; 5-pole; Length: 7.5 m	 Item No.: 756-3506/050-003 Power cable; M12L socket; angled; M12L plug; angled; 5-pole; Length: 0.3 m
 Item No.: 756-3506/050-005 Power cable; M12L socket; angled; M12L plug; angled; 5-pole; Length: 0.5 m	 Item No.: 756-3506/050-010 Power cable; M12L socket; angled; M12L plug; angled; 5-pole; Length: 1 m	 Item No.: 756-3506/050-100 Power cable; M12L socket; angled; M12L plug; angled; 5-pole; Length: 10 m	 Item No.: 756-3506/050-150 Power cable; M12L socket; angled; M12L plug; angled; 5-pole; Length: 15 m
 Item No.: 756-3506/050-020 Power cable; M12L socket; angled; M12L plug; angled; 5-pole; Length: 2 m	 Item No.: 756-3506/050-050 Power cable; M12L socket; angled; M12L plug; angled; 5-pole; Length: 5 m	 Item No.: 756-3506/050-075 Power cable; M12L socket; angled; M12L plug; angled; 5-pole; Length: 7.5 m	 Item No.: 756-3501/050-100 Power cable; M12L socket; straight; 5-pole; Length: 10 m
 Item No.: 756-3501/050-150 Power cable; M12L socket; straight; 5-pole; Length: 15 m	 Item No.: 756-3501/050-020 Power cable; M12L socket; straight; 5-pole; Length: 2 m	 Item No.: 756-3501/050-050 Power cable; M12L socket; straight; 5-pole; Length: 5 m	 Item No.: 756-3501/050-075 Power cable; M12L socket; straight; 5-pole; Length: 7.5 m
 Item No.: 756-3505/050-003 Power cable; M12L socket; straight; M12L plug; straight; 5-pole; Length: 0.3 m	 Item No.: 756-3505/050-005 Power cable; M12L socket; straight; M12L plug; straight; 5-pole; Length: 0.5 m	 Item No.: 756-3505/050-010 Power cable; M12L socket; straight; M12L plug; straight; 5-pole; Length: 1 m	 Item No.: 756-3505/050-100 Power cable; M12L socket; straight; M12L plug; straight; 5-pole; Length: 10 m
 Item No.: 756-3505/050-150 Power cable; M12L socket; straight; M12L plug; straight; 5-pole; Length: 15 m	 Item No.: 756-3505/050-020 Power cable; M12L socket; straight; M12L plug; straight; 5-pole; Length: 2 m	 Item No.: 756-3505/050-050 Power cable; M12L socket; straight; M12L plug; straight; 5-pole; Length: 5 m	 Item No.: 756-3505/050-075 Power cable; M12L socket; straight; M12L plug; straight; 5-pole; Length: 7.5 m

1.2.1.7 Sensor/actuator cable

 Item No.: 756-5312/050-015 Sensor/Actuator cable; M12A plug; angled; 5-pole; Length: 1.5 m	 Item No.: 756-5312/050-100 Sensor/Actuator cable; M12A plug; angled; 5-pole; Length: 10 m	 Item No.: 756-5312/050-050 Sensor/Actuator cable; M12A plug; angled; 5-pole; Length: 5 m	 Item No.: 756-5311/050-015 Sensor/Actuator cable; M12A plug; straight; 5-pole; Length: 1.5 m
 Item No.: 756-5311/050-100 Sensor/Actuator cable; M12A plug; straight; 5-pole; Length: 10 m	 Item No.: 756-5311/050-050 Sensor/Actuator cable; M12A plug; straight; 5-pole; Length: 5 m	 Item No.: 756-5404/050-010 Sensor/Actuator cable; M12A socket; angled; M12A plug; angled; 5-pole; Length: 1 m	 Item No.: 756-5404/050-020 Sensor/Actuator cable; M12A socket; angled; M12A plug; angled; 5-pole; Length: 2 m
 Item No.: 756-5403/050-010 Sensor/Actuator cable; M12A socket; angled; M12A plug; straight; 5-pole; Length: 1 m	 Item No.: 756-5403/050-020 Sensor/Actuator cable; M12A socket; angled; M12A plug; straight; 5-pole; Length: 2 m	 Item No.: 756-5402/050-010 Sensor/Actuator cable; M12A socket; straight; M12A plug; angled; 5-pole; Length: 1 m	 Item No.: 756-5402/050-020 Sensor/Actuator cable; M12A socket; straight; M12A plug; angled; 5-pole; Length: 2 m

1.2.1.7 Sensor/actuator cable



Item No.: 756-5401/050-010

Sensor/Actuator cable; M12A socket;
straight; M12A plug; straight; 5-pole;
Length: 1 m

Item No.: 756-5401/050-020

Sensor/Actuator cable; M12A socket;
straight; M12A plug; straight; 5-pole;
Length: 2 m