

Data Sheet | Item Number: 750-474/005-000
 2-channel analog input; 4 ... 20 mA; Single-ended; 16 bits; 60 Hz

<https://www.wago.com/750-474/005-000>

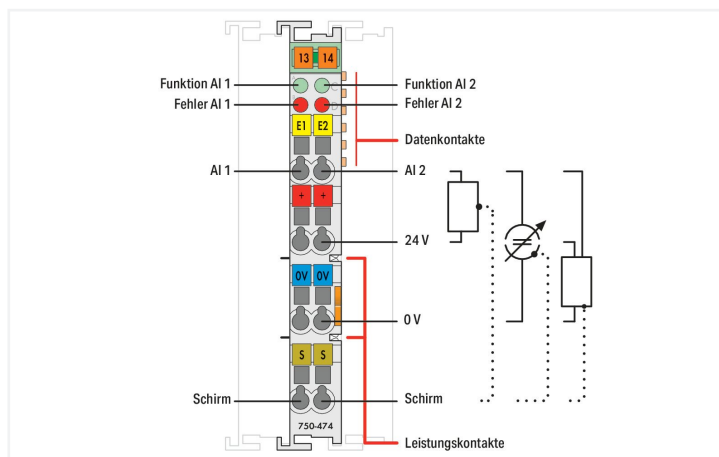

Color: ■ light gray

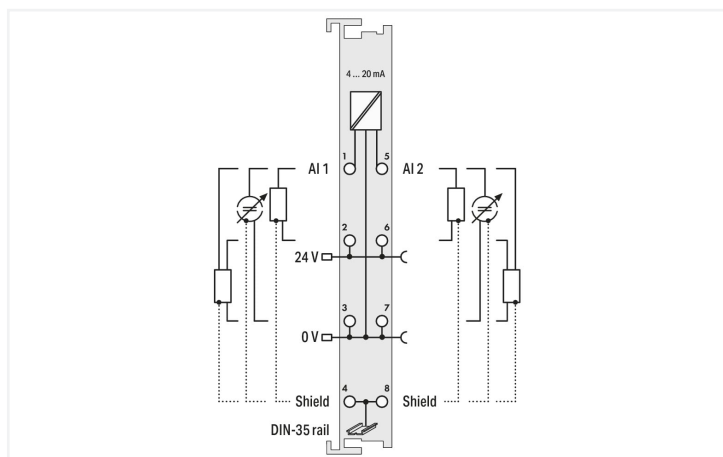
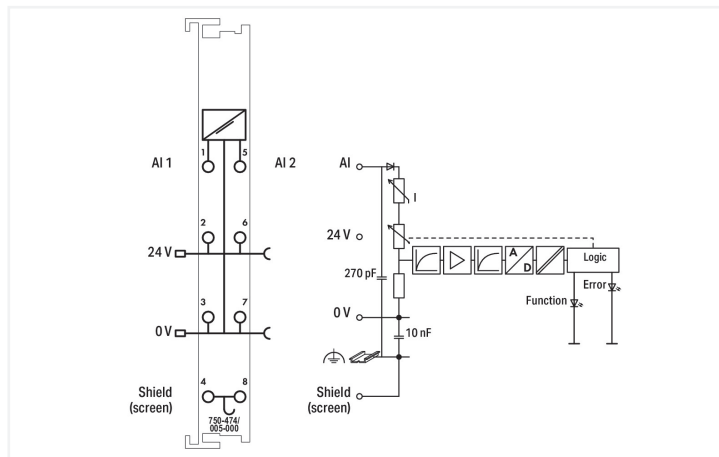

This analog input module powers field-side signal conditioners and transmits electrically isolated analog signals to the bus system.

The 24 V field supply is derived from the module's power jumper contacts.

The shield directly connects to the DIN-rail.

At approximately 25 mA, overload protection switches the measurement input to a high-resistance state. Once normal operating conditions resume, the measurement input will automatically switch back.

This module powers 2-wire signal conditioners without dedicated power supply.

Technical data

Number of analog inputs	2
Total number of channels (module)	2
Signal type	Current
Signal type (current)	4 ... 20 mA DC
Sensor connection	2 x (2-wire, 3-wire)
Input filter frequency (analog)	60 Hz
Input voltage (max.)	24 V
Input voltage (note)	Non-linear, overload protected $U = 1.2 \text{ V} + 160 \Omega \times I \text{ meas}$
Signal characteristics	Single-ended
Resolution [bit]	15 bits
Input resistance (max.)	220 Ω
Data width	2 x 16-bit data; 2 x 8-bit control/status (optional)
Overvoltage protection	30 V, reverse polarity protected
Noise rejection at sampling frequency	-100 dB
Noise rejection above sampling frequency	-40 dB
Conversion time (typ.)	80 ms
Measurement error (reference temperature)	25 $^{\circ}\text{C}$

Technical data

Measurement error, deviation (max.) from the upper-range value	0.1 %
Temperature error (max.) of the upper-range value	0.01 %/K
Supply voltage (system)	5 VDC; via data contacts
Current consumption (5 V system supply)	75 mA
Supply voltage (field)	24 VDC (-25 ... +30 %); via power jumper contacts (power supply via blade contact; transmission via spring contact)
Isolation	500 V system/field
Indicators	LED (A, C) green: Function AI 1, AI 2; LED (B, D) red: Error AI 1, AI 2
Number of incoming power jumper contacts	2
Number of outgoing power jumper contacts	2

Connection data

Connection technology: inputs/outputs	8 x CAGE CLAMP®
Connection type 1	Inputs/outputs
Solid conductor	0.08 ... 2.5 mm ² / 28 ... 14 AWG
Fine-stranded conductor	0.08 ... 2.5 mm ² / 28 ... 14 AWG
Strip length	8 ... 9 mm / 0.31 ... 0.35 inches

Physical data

Width	12 mm / 0.472 inches
Height	100 mm / 3.937 inches
Depth	69.8 mm / 2.748 inches
Depth from upper-edge of DIN-rail	62.6 mm / 2.465 inches

Mechanical data

Mounting type	DIN-35 rail
---------------	-------------

Material data

Color	light gray
Housing material	Polycarbonate; polyamide 6.6
Fire load	1.014 MJ
Weight	52.6 g
Conformity marking	CE

Environmental requirements

Ambient temperature (operation)	0 ... +55 °C
Ambient temperature (storage)	-40 ... +85 °C
Protection type	IP20
Pollution degree	2 per IEC 61131-2
Operating altitude	0 ... 2000 m / 0 ... 6562 ft
Mounting position	horizontal (standing/lying); vertical
Relative humidity (without condensation)	95 %
Vibration resistance	4g per IEC 60068-2-6
Shock resistance	15g per IEC 60068-2-27
EMC immunity to interference	per EN 61000-6-2, marine applications
EMC emission of interference	per EN 61000-6-4, marine applications
Exposure to pollutants	per IEC 60068-2-42 and IEC 60068-2-43
Permissible H ₂ S contaminant concentration at a relative humidity 75 %	10 ppm
Permissible SO ₂ contaminant concentration at a relative humidity 75 %	25 ppm

Commercial data

Product Group	15 (I/O System)
eCl@ss 10.0	27-24-26-01
eCl@ss 9.0	27-24-26-01
ETIM 8.0	EC001596
ETIM 7.0	EC001596
PU (SPU)	1 pcs
Packaging type	Box
Country of origin	DE
GTIN	4045454393328
Customs tariff number	85389099990

Environmental Product Compliance

CAS-No.	1303-86-2 1317-36-8 25550-51-0 7439-92-1
REACH Candidate List Substance	4-Methyl-1,2-cyclohexanedicarboxylic anhydride Diboron trioxide Lead Lead monoxide
RoHS Compliance Status	Compliant,With Exemption
RoHS Exemption	6(c) 7(a) 7(c)-I 7(c)-II
SCIP notification number (Austria)	ebefc3ae-5a7a-45e1-a52f-8b1e8d613411
SCIP notification number (Belgium)	ac62d792-722f-4c15-a67f-73009cfe5276
SCIP notification number (Bulgaria)	6d47ba56-efeb-4553-b05c-71692429540c
SCIP notification number (Czech Republic)	5442f626-3045-4cbb-abd2-cef86c93729f
SCIP notification number (Denmark)	2378bedb-8c60-4275-b37c-66909fc1c3f0
SCIP notification number (Finland)	7eb4830c-10be-42e6-b9fa-e1480a7584de
SCIP notification number (France)	9530970c-3d21-4243-8398-4717973621dd
SCIP notification number (Germany)	53c5b5b5-a1c2-4ecc-af28-7699a53b3aa6
SCIP notification number (Hungary)	aacc3980-ff76-4a68-bbba-ed2b364b43b8
SCIP notification number (Italy)	732284de-b78a-454f-aafb-7f2aff4f8b03
SCIP notification number (Netherlands)	4deb5dc0-9d22-4eb8-9402-16454713e9bf
SCIP notification number (Poland)	71d3bbf3-cdf0-4515-9273-9cc680bf9e5f
SCIP notification number (Romania)	a4ffb8a3-1aaf-436f-88cb-f8e0033e9269
SCIP notification number (Sweden)	991e72e4-6153-4b86-b343-ab428b52e946

Approvals / Certificates

General approvals



Approval	Standard	Certificate Name
EAC Brjansker Zertifizierungsstelle	TP TC 020/2011	EAC RU C-DE.AM02. B.00087/19
KC National Radio Research Agency	Article 58-2, Clause 3	MSIP-REM-W43-AIM750
UL Underwriters Laboratories Inc. (ORDINARY LOCATIONS)	UL 508	E175199 Sec.1

Declarations of conformity and manufacturer's declarations

Approval	Standard	Certificate Name
EU-Declaration of Conformity WAGO GmbH & Co. KG	-	-
UK-Declaration of Conformity WAGO GmbH & Co. KG	-	-

Approvals for marine applications



Approval	Standard	Certificate Name
ABS American Bureau of Shipping	-	22-2219060
BSH Bundesamt fuer Seeschifffahrt und Hydrographie	-	1104
BV Bureau Veritas S.A.	-	13453/E0 BV
DNV DNV GL SE	DNV-CG-0339, Aug. 2021	TAA0000194
KR Korean Register of Shipping	-	KR HMB05880-AC001
LR Lloyds Register EMEA	-	LR22180952TA
PRS Polski Rejestr Statków	-	TE/2236/880590/19
RINA RINA Germany GmbH	-	ELE343521XG001

Approvals for hazardous areas



Approval	Standard	Certificate Name
ATEX TUEV Nord Cert GmbH	EN 60079-0	TUEV14ATEX148929X (II 3 G Ex ec IIC T4 Gc)
CCCEX CQST/CNEx	CNCA-C23-01	2020312310000213 (Ex ec IIC T4 Gc)
EAC Brjansker Zertifizierungsstelle	TP TC 012/2011	EAC RU C-DE.AM02. B.00163/19 (2Ex nA IIC T4 Gc X)
IECEX TUEV Nord Cert GmbH	IEC 60079-0	IECEX TUN 14.0035 X (Ex ec IIC T4 Gc)
INMETRO TUV Rheinland do Brasil Ltda.	IEC 60079-0	BR-Ex_TUV 12.1297 X
UKEx WAGO GmbH & Co. KG	EN 60079-0	UKCA_WA GO22UKEX003X_ec
UL Underwriters Laboratories Inc. (HAZARDOUS LOCATIONS)	UL 121201	E198726 Sec.1

Downloads

Environmental Product Compliance

Compliance Search
Environmental Product Compliance 750-474/005-000 ↓

Documentation

Manual			
Product Manual 2-channel, 4-20mA, single-ended	V 1.1.0	pdf 2103.52 KB	↓
System Manual WAGO I/O System 750/753	V 3.3.3 29.08.2023	pdf 8512.61 KB	↓
System Manual Series 750/753			↓

System Description			
750/753 Series I/O-System – General Product Information		pdf 953.35 KB	↓
Overview on WAGO-I/O-SYSTEM 750 approvals		pdf 770.48 KB	↓

Bid Text			
750-474/005-000	19.02.2019	xml 4.71 KB	↓
750-474/005-000	17.10.2017	doc 28.00 KB	↓

Instruction Leaflet			
CCC Ex (Additional information)	26.04.2023	pdf 159.76 KB	↓

CAD/CAE-Data

CAD data	CAE data
2D/3D Models 750-474/005-000	EPLAN Data Portal 750-474/005-000
	WSCAD Universe 750-474/005-000
	ZUKEN Portal 750-474/005-000

Device Files

Device Driver			
WAGO USB Service Kabel Treiber / Serie 750 und 857	6.5.3.0 10.09.2014	zip 4721.96 KB	

1 Compatible Products

1.1 Optional Accessories

1.1.1 DIN-rail

1.1.1.1 Mounting accessories



Item No.: 210-196
 Aluminum carrier rail; 35 x 8.2 mm; 1.6 mm thick; 2 m long; unslotted; similar to EN 60715; silver-colored



Item No.: 210-198
 Copper carrier rail; 35 x 15 mm; 2.3 mm thick; 2 m long; unslotted; according to EN 60715; copper-colored



Item No.: 210-508
 Steel carrier rail; 35 x 15 mm; 1.5 mm thick; 2 m long; slotted; galvanized; similar to EN 60715; silver-colored



Item No.: 210-197
 Steel carrier rail; 35 x 15 mm; 1.5 mm thick; 2 m long; slotted; similar to EN 60715; silver-colored



Item No.: 210-506
 Steel carrier rail; 35 x 15 mm; 1.5 mm thick; 2 m long; unslotted; galvanized; similar to EN 60715; silver-colored



Item No.: 210-114
 Steel carrier rail; 35 x 15 mm; 1.5 mm thick; 2 m long; unslotted; similar to EN 60715; silver-colored



Item No.: 210-118
 Steel carrier rail; 35 x 15 mm; 2.3 mm thick; 2 m long; unslotted; according to EN 60715; silver-colored



Item No.: 210-115
 Steel carrier rail; 35 x 7.5 mm; 1 mm thick; 2 m long; slotted; according to EN 60715; "Hole width 18 mm; silver-colored



Item No.: 210-112
 Steel carrier rail; 35 x 7.5 mm; 1 mm thick; 2 m long; slotted; according to EN 60715; "Hole width 25 mm; silver-colored



Item No.: 210-504
 Steel carrier rail; 35 x 7.5 mm; 1 mm thick; 2 m long; slotted; galvanized; according to EN 60715; silver-colored



Item No.: 210-113
 Steel carrier rail; 35 x 7.5 mm; 1 mm thick; 2 m long; unslotted; according to EN 60715; silver-colored



Item No.: 210-505
 Steel carrier rail; 35 x 7.5 mm; 1 mm thick; 2 m long; unslotted; galvanized; according to EN 60715; silver-colored











1.1.2 Marking

1.1.2.1 Group marker carrier



Item No.: 750-106
 Group marker carrier

1.1.2.2 Marker

 <p>Item No.: 750-100 Marker card; as a DIN A4 sheet; plain</p>	<p>Item No.: 2009-145/000-006 Mini-WSB Inline; for Smart Printer; 1700 pieces on roll; stretchable 5 - 5.2 mm; plain; snap-on type; blue</p>	<p>Item No.: 2009-145/000-007 Mini-WSB Inline; for Smart Printer; 1700 pieces on roll; stretchable 5 - 5.2 mm; plain; snap-on type; gray</p>	<p>Item No.: 2009-145/000-023 Mini-WSB Inline; for Smart Printer; 1700 pieces on roll; stretchable 5 - 5.2 mm; plain; snap-on type; green</p>
<p>Item No.: 2009-145/000-012 Mini-WSB Inline; for Smart Printer; 1700 pieces on roll; stretchable 5 - 5.2 mm; plain; snap-on type; orange</p>	<p>Item No.: 2009-145/000-005 Mini-WSB Inline; for Smart Printer; 1700 pieces on roll; stretchable 5 - 5.2 mm; plain; snap-on type; red</p>	<p>Item No.: 2009-145/000-024 Mini-WSB Inline; for Smart Printer; 1700 pieces on roll; stretchable 5 - 5.2 mm; plain; snap-on type; violet</p>	<p>Item No.: 2009-145 Mini-WSB Inline; for Smart Printer; 1700 pieces on roll; stretchable 5 - 5.2 mm; plain; snap-on type; white</p>
<p>Item No.: 2009-145/000-002 Mini-WSB Inline; for Smart Printer; 1700 pieces on roll; stretchable 5 - 5.2 mm; plain; snap-on type; yellow</p>	 <p>Item No.: 248-501/000-006 Mini-WSB marking card; as card; not stretchable; plain; snap-on type; blue</p>	 <p>Item No.: 248-501/000-007 Mini-WSB marking card; as card; not stretchable; plain; snap-on type; gray</p>	 <p>Item No.: 248-501/000-023 Mini-WSB marking card; as card; not stretchable; plain; snap-on type; green</p>
 <p>Item No.: 248-501/000-017 Mini-WSB marking card; as card; not stretchable; plain; snap-on type; light green</p>	 <p>Item No.: 248-501/000-012 Mini-WSB marking card; as card; not stretchable; plain; snap-on type; orange</p>	 <p>Item No.: 248-501/000-005 Mini-WSB marking card; as card; not stretchable; plain; snap-on type; red</p>	 <p>Item No.: 248-501/000-024 Mini-WSB marking card; as card; not stretchable; plain; snap-on type; violet</p>
 <p>Item No.: 248-501 Mini-WSB marking card; as card; not stretchable; plain; snap-on type; white</p>	 <p>Item No.: 248-501/000-002 Mini-WSB marking card; as card; not stretchable; plain; snap-on type; yellow</p>		

1.1.2.3 Marker carrier

 <p>Item No.: 750-103 Group marker carrier</p>
--

1.1.3 Shield termination

1.1.3.1 Shield clamping saddles

 <p>Item No.: 790-108 Shield clamping saddle; 11 mm wide; diameter of compatible conductor; 3 ... 8 mm</p>	 <p>Item No.: 790-208 Shield clamping saddle; 12.4 mm wide; 3 ... 8 mm</p>	 <p>Item No.: 790-116 Shield clamping saddle; 19 mm wide; diameter of compatible conductor; 7 ... 16 mm</p>	 <p>Item No.: 790-216 Shield clamping saddle; 21.8 mm wide; 6 ... 16 mm</p>
 <p>Item No.: 790-124 Shield clamping saddle; 27 mm wide; diameter of compatible conductor; 6 ... 24 mm</p>	 <p>Item No.: 790-220 Shield clamping saddle; 30 mm wide; 6 ... 20 mm</p>	 <p>Item No.: 790-140 Shield clamping saddle; diameter of compatible conductor</p>	

1.1.4 Supply module

1.1.4.1 Supply module



Item No.: 750-612

Power Supply; 0 ... 230 V AC/DC

Item No.: 750-602

Power Supply; 24 VDC

Item No.: 750-601

Power Supply; 24 VDC; fuse holder

Item No.: 750-610

Power Supply; 24 VDC; fuse holder; Diagnostics

1.1.5 System enclosure

1.1.5.1 System enclosure



Item No.: 850-825

IP65 enclosure; Aluminium (RAL 7032); WxHxD (160x100x160 mm); 9 x M12, 4 x M20

Item No.: 850-826

IP65 enclosure; Aluminium (RAL 7032); WxHxD (240x100x160 mm); 4 x M20, 4 x M16, 14 x M12 cable grip

Item No.: 850-827

IP65 enclosure; Aluminium (RAL 7032); WxHxD (320x100x160 mm); 4 x M20, 8 x M16, 17 x M12 cable grip

Item No.: 850-828

IP65 enclosure; Aluminium (RAL 7032); WxHxD (480x100x160 mm); 4 x M20, 10 x M16, 35 x M12 cable grip



Item No.: 850-826/002-000

IP65 enclosure; Aluminium (RAL 7035); WxHxD (240x100x160 mm); 4 x M20, 4 x M16, 14 x M12 cable grip

Item No.: 850-827/002-000

IP65 enclosure; Aluminium (RAL 7035); WxHxD (320x100x160 mm); 4 x M20, 8 x M16, 17 x M12 cable grip

Item No.: 850-828/002-000

IP65 enclosure; Aluminium (RAL 7035); WxHxD (480x100x160 mm); 4 x M20, 10 x M16, 35 x M12 cable grip

Item No.: 850-834

IP65 enclosure; Polyester (RAL 7032); WxHxD (164x100x164 mm); 9 x M12, 4 x M20



Item No.: 850-835

IP65 enclosure; Polyester (RAL 7032); WxHxD (244x100x164 mm); 4 x M20, 4 x M16, 14 x M12 cable grip

Item No.: 850-836

IP65 enclosure; Polyester (RAL 7032); WxHxD (324x100x164 mm); 4 x M20, 8 x M16, 17 x M12 cable grip

Item No.: 850-814/002-000

IP65 enclosure; Sheet steel (RAL 7035); WxHxD (200x120x200 mm); without flange plate

Item No.: 850-815/002-000

IP65 enclosure; Sheet steel (RAL 7035); WxHxD (300x120x200 mm); without flange plate



Item No.: 850-816/002-000

IP65 enclosure; Sheet steel (RAL 7035); WxHxD (400x120x200 mm); without flange plate

Item No.: 850-817/002-000

IP65 enclosure; Sheet steel (RAL 7035); WxHxD (600x120x200 mm); without flange plate