

Data Sheet | Item Number: 765-1104/100-000

8-channel digital input/output; Profinet; DC 24 V / 2.0 A; 4xM12 connection; SlimLine

<https://www.wago.com/765-1104/100-000>

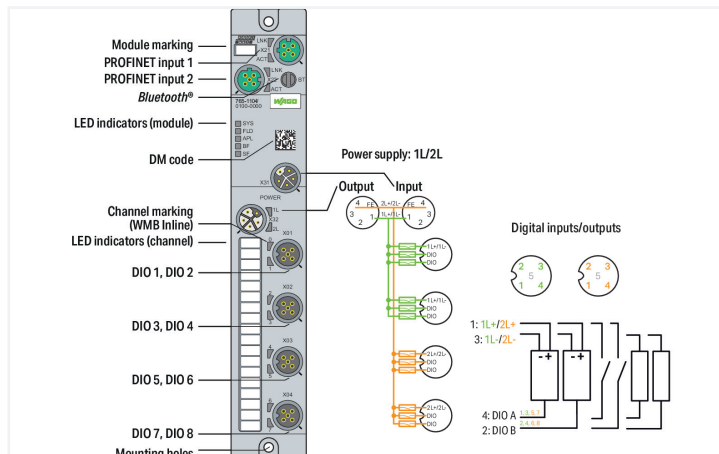

Einsatzbereich:

Dezentrale Verarbeitung von Digitalsignalen.

Das Gerät dient zur Erfassung und Ansteuerung digitaler Feldgeräte, z. B. von Sensoren und Aktoren, die von einer übergeordneten Steuerung empfangen bzw. angesteuert werden.

Das Gerät bietet 8 digitale Ein-/Ausgänge.

Technical data

Fieldbus

Communication	PROFINET PROFINET IO device; 2-port switch, LLDP, MRP, SNMP
Connection technology: communication/fieldbus	2 x D-coded M12; 4-pole
Interface standard	10BASE-T/100BASE-TX; potential-free
Autonegotiation; autocrossover	Yes
PROFINET IO features	PROFINET IO device; 2-port switch, LLDP, MRP, SNMP

Device functions

Parameter	Input filter Output current Temperature
Diagnostics	Undervoltage; overcurrent; overload; overtemperature
Device functions	Bluetooth® OPC UA server
Visualization	Android/iOS app Web server

Digital inputs/outputs

Number of digital inputs	8
Number of digital outputs	8
Connection technology: inputs/outputs	4 x A-coded M12; 5-pole
Signal type (voltage)	24 VDC
Input characteristic	high-side switching Type 3, per IEC 61131-2
Input filter	0.2 ... 20 ms
Output current (per channel)	2 A (typ.) for DO
Supply current per port	1L/2L: 4 A (max.)

Supply (module)

Connection technology: supply	2 x L-coded M12; 5-pole
Supply voltage	24 VDC (18 ... 31.2 V); 1L/2L
Current consumption (max.)	16000 mA
Current consumption (note)	per supply line; overload- and short-circuit-protected
Reverse voltage protection	Yes

Physical data

Width	35 mm / 1.378 inches
Height	30 mm / 1.181 inches
Depth	210 mm / 8.268 inches

Mechanical data

Weight	380 g
Conformity marking	CE

Environmental requirements

Ambient temperature (operation)	-25 ... +70 °C
Ambient temperature (storage)	-40 ... +80 °C
Protection type	IP67
Protection class	III per EN 61140, IEC 61140, VDE 0140-1
Operating altitude	0 ... 2000 m / 0 ... 6562 ft
Pollution degree	3 (EN 60664-1)
Overvoltage category	II (EN 60664-1)
Relative humidity (without condensation)	95 %
Vibration resistance	5g per IEC 60068-2-6
Shock resistance	Short-term: 50g/11 ms/half-sine per IEC 60068-2-27; Long-term: 30g/6 ms/half-sine per IEC 60068-2-29
EMC immunity to interference	per EN 61000-6-2
EMC emission of interference	per EN 61000-6-4

Commercial data

ETIM 8.0	EC001599
ETIM 7.0	EC001599
PU (SPU)	1 pcs
Packaging type	Box
Country of origin	DE
GTIN	4055143949774
Customs tariff number	85371098990

Environmental Product Compliance

CAS-No.	7439-92-1
REACH Candidate List Substance	Lead
RoHS Compliance Status	Compliant,With Exemption
RoHS Exemption	6(c) 7(a) 7(c)-I
SCIP notification number (Austria)	f2e110cc-9b1f-461a-bdec-0d0211297b79
SCIP notification number (Belgium)	b38cdd4b-8953-48c5-9f55-947117a67b86
SCIP notification number (Bulgaria)	04ed8526-93e2-49fa-935a-225bfa001970
SCIP notification number (Czech Republic)	87e76cc5-6434-44b3-a03d-1bd827a5a6b9
SCIP notification number (Denmark)	342806e9-28fc-45e7-a25e-af0685f1becf
SCIP notification number (Finland)	8acc68fc-5d51-4c3f-b738-6b8ce38aea61
SCIP notification number (France)	3fbee338-7bb0-4b2d-9852-1cd74194038d
SCIP notification number (Germany)	a88a6226-9dd0-4ab0-93a8-c55a91056042
SCIP notification number (Hungary)	ebd66ed6-8ed1-4bcf-9510-24f6e3188282
SCIP notification number (Italy)	e2cdfab4-af28-4ce1-bedd-ee26cd1fd839
SCIP notification number (Netherlands)	73477f8a-fc3e-460e-a625-f78caab486e0
SCIP notification number (Poland)	239ac059-ac2f-4ff2-8502-858e239323f0
SCIP notification number (Romania)	ea112445-6a92-413f-88c8-0fea5add5443
SCIP notification number (Sweden)	35afc193-f2d9-4c48-bdc5-d45b87492758

Approvals / Certificates

General approvals



Approval	Standard	Certificate Name
KC National Radio Research Agency	Article 58-2, Clause 3	KC R-R-W43-FB765

Downloads

Environmental Product Compliance

Compliance Search

Environmental Product
Compliance
765-1104/100-000



Documentation

Manual

Product Manual 8- Channel Digital Input/ Output; Profinet	V 2.2.0 19.07.2022	pdf 7415.89 KB	
---	-----------------------	-------------------	---

System Description

WAGO I/O System Field; General Product Infor- mation	pdf 1009.23 KB	
--	-------------------	---

Instruction Leaflet

I/O System Field packa- ge insert	15.12.2021	pdf 1083.98 KB	
--------------------------------------	------------	-------------------	---

CAD/CAE-Data

CAD data

2D/3D Models 765-1104/100-000	
----------------------------------	---

CAE data

EPLAN Data Portal 765-1104/100-000	
ZUKEN Portal 765-1104/100-000	



Runtime Software

Firmware

0765-x1xx, Profinet IO- Field	V 04 02.02.2023	zip 1595.41 KB	
----------------------------------	--------------------	-------------------	---

Libraries

Device Description File

750-916; GSD files of version 2.x for PROFINET/ series 750/753, 765, 767 and 852	3.0 15.01.2023	zip 2582.40 KB	
Gerätebeschreibungsdateien 765-41xx, 765-11xx, PROFINET	V1_1_0_22	zip 27.85 KB	

1 Compatible Products

1.1 Required Accessories

1.1.1 Cover

1.1.1.1 Cover



Item No.: [756-8103](#)

M12 protective cap; for unused plugs

Item No.: [756-8102](#)

M12 protective cap; for unused sockets

1.1.2 Marking

1.1.2.1 Marker



Item No.: [2009-115](#)

WMB-Inline; for Smart Printer; 1500 pieces on roll; stretchable 5 - 5.2 mm; plain; snap-on type; white

1.1.2.2 Marking strip



Item No.: [2009-110](#)

Marking strips; for Smart Printer; on reel; not stretchable; plain; snap-on type; white

1.1.3 Tool

1.1.3.1 Assembly tool



Item No.: [206-701](#)

Torque wrench M8 and M12; Assembly kit

1.2 Optional Accessories

1.2.1 Cables and connectors

1.2.1.1 Adapter



[Item No.: 756-9503/040-000](#)
Accessories; 4-pole

[Item No.: 756-9504/040-000](#)
Accessories; 4-pole

1.2.1.2 Configurable connector



[Item No.: 756-9205/040-000](#)
Fitted pluggable connector; 4-pole; M12 plug, right angle; Spring

[Item No.: 756-9202/040-000](#)
Fitted pluggable connector; 4-pole; M12 plug, straight, A-coded; Spring

[Item No.: 756-9701/050-000](#)
Fitted pluggable connector; 5-pole, shielded; M12 plug, straight; IDC technology

[Item No.: 756-9711/050-000](#)
Fitted pluggable connector; 5-pole, shielded; M12 socket, straight; IDC technology

1.2.1.3 Configurable shielded connector



[Item No.: 756-9501/040-000](#)
Accessories; M12 plug, right angle; 4-pole

[Item No.: 756-9501/060-000](#)
Fitted pluggable connector; 4-pole, shielded; M12 plug, straight, D-coded; Spring

1.2.1.4 Distribution connector



[Item No.: 756-9301/040-000](#)
Accessories; 4-pole

[Item No.: 756-9301/050-000](#)
Accessories; 5-pole

[Item No.: 756-5517/040-010](#)
Sensor/Actuator cable; 2xM12 socket; angled; M12A plug; straight; 4-pole; Length: 1 m

[Item No.: 756-5517/040-020](#)
Sensor/Actuator cable; 2xM12 socket; angled; M12A plug; straight; 4-pole; Length: 2 m



[Item No.: 756-5516/040-010](#)
Sensor/Actuator cable; 2xM12 socket; straight; M12A plug; straight; 4-pole; Length: 1 m

[Item No.: 756-5516/040-020](#)
Sensor/Actuator cable; 2xM12 socket; straight; M12A plug; straight; 4-pole; Length: 2 m

[Item No.: 756-5514/040-010](#)
Sensor/Actuator cable; 2xM8 socket; angled; M12A plug; straight; 4-pole; Length: 1 m

[Item No.: 756-5514/040-020](#)
Sensor/Actuator cable; 2xM8 socket; angled; M12A plug; straight; 4-pole; Length: 2 m



[Item No.: 756-5513/040-010](#)
Sensor/Actuator cable; 2xM8 socket; straight; M12A plug; straight; 4-pole; Length: 1 m

[Item No.: 756-5513/040-020](#)
Sensor/Actuator cable; 2xM8 socket; straight; M12A plug; straight; 4-pole; Length: 2 m

1.2.1.5 ETHERNET/PROFINET cable



[Item No.: 756-1202/060-100](#)
ETHERNET cable; M12D plug; angled; 4-pole; Length: 10 m

[Item No.: 756-1202/060-020](#)
ETHERNET cable; M12D plug; angled; 4-pole; Length: 2 m

[Item No.: 756-1202/060-200](#)
ETHERNET cable; M12D plug; angled; 4-pole; Length: 20 m

[Item No.: 756-1202/060-050](#)
ETHERNET cable; M12D plug; angled; 4-pole; Length: 5 m



[Item No.: 756-1204/060-010](#)
ETHERNET cable; M12D plug; angled; M12D plug; angled; 4-pole; Length: 1 m

[Item No.: 756-1204/060-100](#)
ETHERNET cable; M12D plug; angled; M12D plug; angled; 4-pole; Length: 10 m

[Item No.: 756-1204/060-020](#)
ETHERNET cable; M12D plug; angled; M12D plug; angled; 4-pole; Length: 2 m

[Item No.: 756-1204/060-200](#)
ETHERNET cable; M12D plug; angled; M12D plug; angled; 4-pole; Length: 20 m



[Item No.: 756-1204/060-030](#)
ETHERNET cable; M12D plug; angled; M12D plug; angled; 4-pole; Length: 3 m

[Item No.: 756-1204/060-050](#)
ETHERNET cable; M12D plug; angled; M12D plug; angled; 4-pole; Length: 5 m

[Item No.: 756-1201/060-100](#)
ETHERNET cable; M12D plug; straight; 4-pole; Length: 10 m

[Item No.: 756-1201/060-020](#)
ETHERNET cable; M12D plug; straight; 4-pole; Length: 2 m

1.2.1.5 ETHERNET/PROFINET cable



Item No.: 756-1201/060-200
ETHERNET cable; M12D plug; straight; 4-pole; Length: 20 m

Item No.: 756-1201/060-050
ETHERNET cable; M12D plug; straight; 4-pole; Length: 5 m

Item No.: 756-1203/060-100
ETHERNET cable; M12D plug; straight; M12D plug; straight; 4-pole; Length: 10 m

Item No.: 756-1203/060-020
ETHERNET cable; M12D plug; straight; M12D plug; straight; 4-pole; Length: 2 m



Item No.: 756-1203/060-200
ETHERNET cable; M12D plug; straight; M12D plug; straight; 4-pole; Length: 20 m

Item No.: 756-1203/060-050
ETHERNET cable; M12D plug; straight; M12D plug; straight; 4-pole; Length: 5 m

1.2.1.6 Power cable



Item No.: 756-3504/050-100
Power cable; M12L plug; angled; 5-pole; Length: 10 m

Item No.: 756-3504/050-150
Power cable; M12L plug; angled; 5-pole; Length: 15 m

Item No.: 756-3504/050-020
Power cable; M12L plug; angled; 5-pole; Length: 2 m

Item No.: 756-3504/050-050
Power cable; M12L plug; angled; 5-pole; Length: 5 m



Item No.: 756-3504/050-075
Power cable; M12L plug; angled; 5-pole; Length: 7.5 m

Item No.: 756-3503/050-100
Power cable; M12L plug; straight; 5-pole; Length: 10 m

Item No.: 756-3503/050-150
Power cable; M12L plug; straight; 5-pole; Length: 15 m

Item No.: 756-3503/050-020
Power cable; M12L plug; straight; 5-pole; Length: 2 m



Item No.: 756-3503/050-050
Power cable; M12L plug; straight; 5-pole; Length: 5 m

Item No.: 756-3503/050-075
Power cable; M12L plug; straight; 5-pole; Length: 7.5 m

Item No.: 756-3502/050-100
Power cable; M12L socket; angled; 5-pole; Length: 10 m

Item No.: 756-3502/050-150
Power cable; M12L socket; angled; 5-pole; Length: 15 m



Item No.: 756-3502/050-020
Power cable; M12L socket; angled; 5-pole; Length: 2 m

Item No.: 756-3502/050-050
Power cable; M12L socket; angled; 5-pole; Length: 5 m

Item No.: 756-3502/050-075
Power cable; M12L socket; angled; 5-pole; Length: 7.5 m

Item No.: 756-3506/050-003
Power cable; M12L socket; angled; M12L plug; angled; 5-pole; Length: 0.3 m



Item No.: 756-3506/050-005
Power cable; M12L socket; angled; M12L plug; angled; 5-pole; Length: 0.5 m

Item No.: 756-3506/050-010
Power cable; M12L socket; angled; M12L plug; angled; 5-pole; Length: 1 m

Item No.: 756-3506/050-100
Power cable; M12L socket; angled; M12L plug; angled; 5-pole; Length: 10 m

Item No.: 756-3506/050-150
Power cable; M12L socket; angled; M12L plug; angled; 5-pole; Length: 15 m



Item No.: 756-3506/050-020
Power cable; M12L socket; angled; M12L plug; angled; 5-pole; Length: 2 m

Item No.: 756-3506/050-050
Power cable; M12L socket; angled; M12L plug; angled; 5-pole; Length: 5 m

Item No.: 756-3506/050-075
Power cable; M12L socket; angled; M12L plug; angled; 5-pole; Length: 7.5 m

Item No.: 756-3501/050-100
Power cable; M12L socket; straight; 5-pole; Length: 10 m



Item No.: 756-3501/050-150
Power cable; M12L socket; straight; 5-pole; Length: 15 m

Item No.: 756-3501/050-020
Power cable; M12L socket; straight; 5-pole; Length: 2 m

Item No.: 756-3501/050-050
Power cable; M12L socket; straight; 5-pole; Length: 5 m

Item No.: 756-3501/050-075
Power cable; M12L socket; straight; 5-pole; Length: 7.5 m



Item No.: 756-3505/050-003
Power cable; M12L socket; straight; M12L plug; straight; 5-pole; Length: 0.3 m

Item No.: 756-3505/050-005
Power cable; M12L socket; straight; M12L plug; straight; 5-pole; Length: 0.5 m

Item No.: 756-3505/050-010
Power cable; M12L socket; straight; M12L plug; straight; 5-pole; Length: 1 m

Item No.: 756-3505/050-100
Power cable; M12L socket; straight; M12L plug; straight; 5-pole; Length: 10 m



Item No.: 756-3505/050-150
Power cable; M12L socket; straight; M12L plug; straight; 5-pole; Length: 15 m

Item No.: 756-3505/050-020
Power cable; M12L socket; straight; M12L plug; straight; 5-pole; Length: 2 m

Item No.: 756-3505/050-050
Power cable; M12L socket; straight; M12L plug; straight; 5-pole; Length: 5 m

Item No.: 756-3505/050-075
Power cable; M12L socket; straight; M12L plug; straight; 5-pole; Length: 7.5 m

1.2.1.7 Sensor/actuator cable



Item No.: 756-5312/040-015
Sensor/Actuator cable; M12A plug; angled; 4-pole; Length: 1.5 m

Item No.: 756-5312/040-100
Sensor/Actuator cable; M12A plug; angled; 4-pole; Length: 10 m

Item No.: 756-5312/040-050
Sensor/Actuator cable; M12A plug; angled; 4-pole; Length: 5 m

Item No.: 756-5311/040-015
Sensor/Actuator cable; M12A plug; straight; 4-pole; Length: 1.5 m



Item No.: 756-5311/040-100
Sensor/Actuator cable; M12A plug; straight; 4-pole; Length: 10 m

Item No.: 756-5311/040-050
Sensor/Actuator cable; M12A plug; straight; 4-pole; Length: 5 m

Item No.: 756-5404/040-010
Sensor/Actuator cable; M12A socket; angled; M12A plug; angled; 4-pole; Length: 1 m

Item No.: 756-5404/040-020
Sensor/Actuator cable; M12A socket; angled; M12A plug; angled; 4-pole; Length: 2 m



Item No.: 756-5403/040-010
Sensor/Actuator cable; M12A socket; angled; M12A plug; straight; 4-pole; Length: 1 m

Item No.: 756-5403/040-020
Sensor/Actuator cable; M12A socket; angled; M12A plug; straight; 4-pole; Length: 2 m

Item No.: 756-5402/040-010
Sensor/Actuator cable; M12A socket; straight; M12A plug; angled; 4-pole; Length: 1 m

Item No.: 756-5402/040-020
Sensor/Actuator cable; M12A socket; straight; M12A plug; angled; 4-pole; Length: 2 m



Item No.: 756-5401/040-010
Sensor/Actuator cable; M12A socket; straight; M12A plug; straight; 4-pole; Length: 1 m

Item No.: 756-5401/040-020
Sensor/Actuator cable; M12A socket; straight; M12A plug; straight; 4-pole; Length: 2 m

Item No.: 756-5510/040-010
Sensor/Actuator cable; M8 socket; angled; M12A plug; angled; 4-pole; Length: 1 m

Item No.: 756-5510/040-020
Sensor/Actuator cable; M8 socket; angled; M12A plug; angled; 4-pole; Length: 2 m



Item No.: 756-5509/040-010
Sensor/Actuator cable; M8 socket; angled; M12A plug; straight; 4-pole; Length: 1 m

Item No.: 756-5509/040-020
Sensor/Actuator cable; M8 socket; angled; M12A plug; straight; 4-pole; Length: 2 m

Item No.: 756-5508/040-010
Sensor/Actuator cable; M8 socket; straight; M12A plug; angled; 4-pole; Length: 1 m

Item No.: 756-5508/040-020
Sensor/Actuator cable; M8 socket; straight; M12A plug; angled; 4-pole; Length: 2 m



Item No.: 756-5507/040-010
Sensor/Actuator cable; M8 socket; straight; M12A plug; straight; 4-pole; Length: 1 m

Item No.: 756-5507/040-020
Sensor/Actuator cable; M8 socket; straight; M12A plug; straight; 4-pole; Length: 2 m