

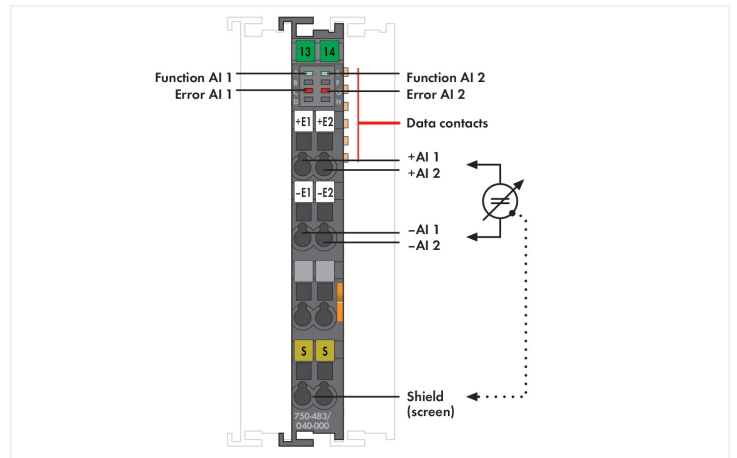

Color: ■ dark gray

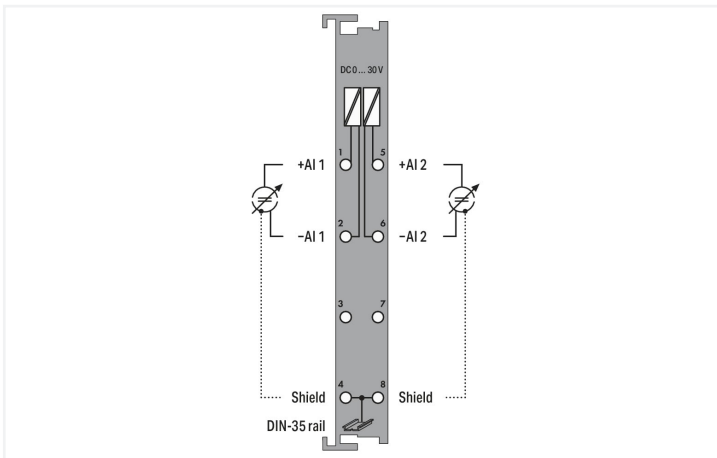
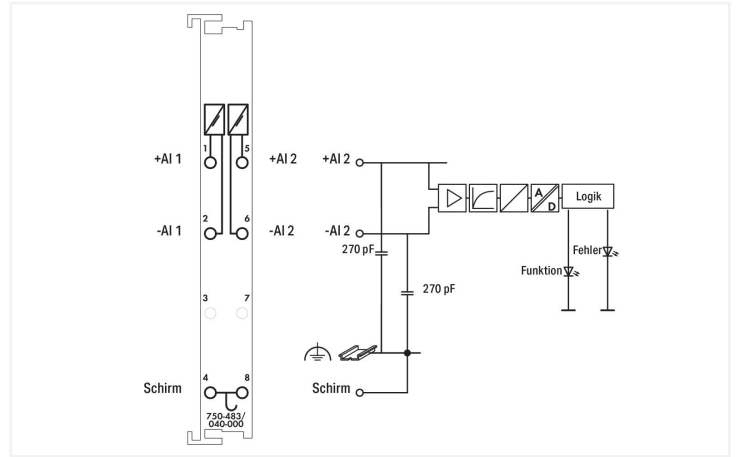

This analog input module processes differential signals ranging from 0 to 30 VDC. The input signal of each channel is electrically isolated and is transmitted with a resolution of 14 bits. The system supply powers the module. The shield directly connects to the DIN-rail.

- Measured value acquisition: Time synchronous within the module
- Measurement range overflow/underflow: Status byte and LED
- Conversion method: SAR (Successive Approximation Register)
- Operating mode: Continuously sampling (default)
- Protection: RC circuit
- **The device is ideal for operation in extreme environments thanks to:**
  - An extended temperature range
  - Greater immunity to impulse voltages and electromagnetic interference
  - Higher vibration and shock resistance

#### Technical data

Number of analog inputs	2
Total number of channels (module)	2
Signal type	Voltage
Signal type (voltage)	0 ... 30 VDC
Sensor connection	2 x (2-wire)
Input filter	Low pass (1st order), $f_c = 5 \text{ kHz}$
Signal characteristics	Differential
Resolution [bit]	14 bits
Data width	2 x 16-bit data; 2 x 8-bit control/status (optional)
Admissible continuous overload	60 V
Crosstalk attenuation	80 dB

### Technical data

Monotonicity without error code	Yes
Internal resistance	1000 k $\Omega$
Conversion time (typ.)	1 ms
Measurement error (reference temperature)	25 °C
Measurement error, deviation (max.) from the upper-range value	0.1 %
Measurement error over entire temperature range	$\leq 0.4$ %
Temperature error (max.) of the upper-range value	0.01 %/K
Sampling duration	5 $\mu$ s
Sampling delay (channel/channel)	1 $\mu$ s
Sampling delay (module)	1 ms
Sampling repetition time	1 ms
Value of the least significant bit (LSB)	1.8 mV
Supply voltage (system)	5 VDC; via data contacts
Current consumption (5 V system supply)	80 mA
Dielectric strength	510 VAC/775 VDC; per EN 60870-2-1
Rated surge voltage	1 kV
Indicators	LED (A, E) green: Function AI 1, AI 2; LED (C, G) red: Error AI 1, AI 2

### Connection data

Connection technology: inputs/outputs	8 x CAGE CLAMP®
Connection type 1	Inputs/outputs
Solid conductor	0.25 ... 2.5 mm <sup>2</sup> / 24 ... 14 AWG
Fine-stranded conductor	0.25 ... 2.5 mm <sup>2</sup> / 24 ... 14 AWG
Strip length	8 ... 9 mm / 0.31 ... 0.35 inches

### Physical data

Width	12 mm / 0.472 inches
Height	100 mm / 3.937 inches
Depth	67.8 mm / 2.669 inches
Depth from upper-edge of DIN-rail	60.6 mm / 2.386 inches

### Mechanical data

Mounting type	DIN-35 rail
---------------	-------------

### Material data

Color	dark gray
Housing material	Polycarbonate; polyamide 6.6
Fire load	0.953 MJ
Weight	47.2 g
Conformity marking	CE

### Environmental requirements

Ambient temperature (operation)	-40 ... +70 °C
Ambient temperature (storage)	-40 ... +85 °C
Protection type	IP20
Pollution degree	2 per IEC 61131-2
Operating altitude	without temperature derating: 0 ... 2000 m; with temperature derating: 2000 ... 5000 m (0.5 K/100 m); 5000 m (max.)
Mounting position	horizontal (standing/lying); vertical
Relative humidity (without condensation)	95 %
Relative humidity (with condensation)	Short-term condensation per Class 3K7/IEC EN 60721-3-3 and E-DIN 40046-721-3 (except for wind-driven precipitation, water and ice formation)
Vibration resistance	per IEC 60068-2-6 (acceleration: 5g), EN 60870-2-2, IEC 60721-3-1, -3, EN 50155; EN 61373
Shock resistance	per IEC 60068-2-27 (15g/11 ms/half-sine/1,000 shocks; 25g/6 ms/1,000 shocks), EN 50155, EN 61373
EMC immunity to interference	per EN 61000-6-1, -2; EN 61131-2; marine applications; EN 50121-3-2; EN 50121-4, -5; EN 60255-26; EN 60870-2-1; EN 61850-3; IEC 61000-6-5; IEEE 1613; VDEW: 1994
EMC emission of interference	per EN 61000-6-3, -4, EN 61131-2, EN 60255-26, marine applications, EN 60870-2-1, EN 61850-3, EN 50121-3-2, EN 50121-4, -5
Exposure to pollutants	per IEC 60068-2-42 and IEC 60068-2-43
Permissible H <sub>2</sub> S contaminant concentration at a relative humidity 75 %	10 ppm
Permissible SO <sub>2</sub> contaminant concentration at a relative humidity 75 %	25 ppm

### Commercial data

eCl@ss 10.0	27-24-26-01
eCl@ss 9.0	27-24-26-01
ETIM 8.0	EC001596
ETIM 7.0	EC001596
PU (SPU)	1 pcs
Packaging type	Box
Country of origin	DE
GTIN	4055143673105
Customs tariff number	85389099990

### Environmental Product Compliance

CAS-No.	1303-86-2 1317-36-8 7439-92-1
REACH Candidate List Substance	Diboron trioxide Lead Lead monoxide Perfluorobutane sulfonic acid (PFBS) and its salts
RoHS Compliance Status	Compliant, With Exemption
RoHS Exemption	6(c) 7(a) 7(c)-I 7(c)-II
SCIP notification number (Austria)	88c29144-d1fc-49b2-8e68-bc055d945552
SCIP notification number (Belgium)	898d25f6-cd94-403e-9fcc-ef51e7817aa3
SCIP notification number (Bulgaria)	7a92a64f-05df-4616-b841-0155becfd1a2
SCIP notification number (Czech Republic)	5dd17aab-2422-4151-ae51-1339481a3dd3
SCIP notification number (Denmark)	07454096-a8da-4ae0-8da9-e7daafeef134
SCIP notification number (Finland)	0545084d-97c4-4589-984b-9639d755fafa
SCIP notification number (France)	dd6bc72b-0bbc-486e-9432-f2b275b45f7b
SCIP notification number (Germany)	6ebf8f20-f7af-4c94-b2d0-898c1764c386
SCIP notification number (Hungary)	8a361b79-0c54-4132-acc4-000b26910056
SCIP notification number (Italy)	624f50ee-08ea-4990-9953-2826db409939
SCIP notification number (Netherlands)	171d12aa-7759-4576-a076-3878440baf80
SCIP notification number (Poland)	3915c769-dabf-4715-bbf4-57b43c0a5b4a

**Environmental Product Compliance**

SCIP notification number (Romania)	abf9a16e-6e88-4a20-ad6b-a33a8dc30610
SCIP notification number (Sweden)	8839f224-8496-4558-8e17-400be469ac5f

**Approvals / Certificates**

**General approvals**



Approval	Standard	Certificate Name
EAC Brjansker Zertifizierungsstelle	TP TC 020/2011	EAC RU C-DE.AM02. B.00087/19
EAC Brjansker Zertifizierungsstelle	TP TC 012/2011	EAC RU C-DE.AZ58. B.2173-21 e (2Ex e IIC T4 Gc X)
UL Underwriters Laboratories Inc. (ORDINARY LOCATIONS)	-	E175199

**Approvals for marine applications**



Approval	Standard	Certificate Name
ABS American Bureau of Shipping	-	22-2208829-PDA
DNV DNV GL SE	-	TAA00000Y7
LR Lloyds Register	-	LR22276776TA
PRS Polski Rejestr Statków	-	TE/2215/880590/18

**Approvals for hazardous areas**



Approval	Standard	Certificate Name
ATEX TUEV Nord Cert GmbH	EN 60079-0	TUEV 17 ATEX 193969X (II 3 G Ex ec IIC T4 Gc)
CCC CNEX	CNCA-C23-01	2020312310000214 (Ex ec IIC T4 Gc)
IECEx TUEV Nord Cert GmbH	IEC 60079-0	IECEx TUN 16.0046X (Ex ec IIC T4 Gc)
UKEx WAGO GmbH & Co. KG	EN 60079-0	UKCA_WA GO22UKEX005X_ec
UL Underwriters Laboratories Inc. (HAZARDOUS LOCATIONS)	UL 121201	E198726 Sec.1

**Downloads**

**Environmental Product Compliance**

Compliance Search
Environmental Product Compliance 750-483/040-000



Documentation

Manual				System Description			
Product Manual 2-channel, 0-30VDC /XTR	V 1.1.0 17.09.2019	pdf 2629.67 KB	<a href="#">↓</a>	Overview on WAGO-I/O-SYSTEM 750 approvals		pdf 770.48 KB	<a href="#">↓</a>
				750 XTR Series I/O-System – General Product Information		pdf 726.09 KB	<a href="#">↓</a>
Bid Text				Instruction Leaflet			
750-483/040-000	12.02.2018	doc 32.00 KB	<a href="#">↓</a>	CCC Ex (Additional information)	26.04.2023	pdf 144.58 KB	<a href="#">↓</a>
750-483/040-000	19.02.2019	xml 7.47 KB	<a href="#">↓</a>				

CAD/CAE-Data













CAD data		CAE data	
2D/3D Models 750-483/040-000	<a href="#">↓</a>	EPLAN Data Portal 750-483/040-000	<a href="#">↓</a>
		ZUKEN Portal 750-483/040-000	<a href="#">↓</a>

1 Compatible Products

1.1 Optional Accessories

1.1.1 DIN-rail

1.1.1.1 Mounting accessories

			
<b>Item No.: 210-196</b> Aluminum carrier rail; 35 x 8.2 mm; 1.6 mm thick; 2 m long; unslotted; similar to EN 60715; silver-colored	<b>Item No.: 210-198</b> Copper carrier rail; 35 x 15 mm; 2.3 mm thick; 2 m long; unslotted; according to EN 60715; copper-colored	<b>Item No.: 210-508</b> Steel carrier rail; 35 x 15 mm; 1.5 mm thick; 2 m long; slotted; galvanized; similar to EN 60715; silver-colored	<b>Item No.: 210-197</b> Steel carrier rail; 35 x 15 mm; 1.5 mm thick; 2 m long; slotted; similar to EN 60715; silver-colored
			
<b>Item No.: 210-506</b> Steel carrier rail; 35 x 15 mm; 1.5 mm thick; 2 m long; unslotted; galvanized; similar to EN 60715; silver-colored	<b>Item No.: 210-114</b> Steel carrier rail; 35 x 15 mm; 1.5 mm thick; 2 m long; unslotted; similar to EN 60715; silver-colored	<b>Item No.: 210-118</b> Steel carrier rail; 35 x 15 mm; 2.3 mm thick; 2 m long; unslotted; according to EN 60715; silver-colored	<b>Item No.: 210-115</b> Steel carrier rail; 35 x 7.5 mm; 1 mm thick; 2 m long; slotted; according to EN 60715; "Hole width 18 mm; silver-colored
			
<b>Item No.: 210-112</b> Steel carrier rail; 35 x 7.5 mm; 1 mm thick; 2 m long; slotted; according to EN 60715; "Hole width 25 mm; silver-colored	<b>Item No.: 210-504</b> Steel carrier rail; 35 x 7.5 mm; 1 mm thick; 2 m long; slotted; galvanized; according to EN 60715; silver-colored	<b>Item No.: 210-113</b> Steel carrier rail; 35 x 7.5 mm; 1 mm thick; 2 m long; unslotted; according to EN 60715; silver-colored	<b>Item No.: 210-505</b> Steel carrier rail; 35 x 7.5 mm; 1 mm thick; 2 m long; unslotted; galvanized; according to EN 60715; silver-colored

### 1.1.2 Marking

#### 1.1.2.1 Group marker carrier



**Item No.: 750-107**  
Group marker carrier

#### 1.1.2.2 Marker

**Item No.: 2009-145/000-006**  
Mini-WSB Inline; for Smart Printer; 1700 pieces on roll; stretchable 5 - 5.2 mm; plain; snap-on type; blue

**Item No.: 2009-145/000-007**  
Mini-WSB Inline; for Smart Printer; 1700 pieces on roll; stretchable 5 - 5.2 mm; plain; snap-on type; gray

**Item No.: 2009-145/000-023**  
Mini-WSB Inline; for Smart Printer; 1700 pieces on roll; stretchable 5 - 5.2 mm; plain; snap-on type; green

**Item No.: 2009-145/000-012**  
Mini-WSB Inline; for Smart Printer; 1700 pieces on roll; stretchable 5 - 5.2 mm; plain; snap-on type; orange

**Item No.: 2009-145/000-005**  
Mini-WSB Inline; for Smart Printer; 1700 pieces on roll; stretchable 5 - 5.2 mm; plain; snap-on type; red

**Item No.: 2009-145/000-024**  
Mini-WSB Inline; for Smart Printer; 1700 pieces on roll; stretchable 5 - 5.2 mm; plain; snap-on type; violet

**Item No.: 2009-145**  
Mini-WSB Inline; for Smart Printer; 1700 pieces on roll; stretchable 5 - 5.2 mm; plain; snap-on type; white

**Item No.: 2009-145/000-002**  
Mini-WSB Inline; for Smart Printer; 1700 pieces on roll; stretchable 5 - 5.2 mm; plain; snap-on type; yellow



**Item No.: 248-501/000-006**  
Mini-WSB marking card; as card; not stretchable; plain; snap-on type; blue

**Item No.: 248-501/000-007**  
Mini-WSB marking card; as card; not stretchable; plain; snap-on type; gray

**Item No.: 248-501/000-023**  
Mini-WSB marking card; as card; not stretchable; plain; snap-on type; green

**Item No.: 248-501/000-017**  
Mini-WSB marking card; as card; not stretchable; plain; snap-on type; light green



**Item No.: 248-501/000-012**  
Mini-WSB marking card; as card; not stretchable; plain; snap-on type; orange

**Item No.: 248-501/000-005**  
Mini-WSB marking card; as card; not stretchable; plain; snap-on type; red

**Item No.: 248-501/000-024**  
Mini-WSB marking card; as card; not stretchable; plain; snap-on type; violet

**Item No.: 248-501**  
Mini-WSB marking card; as card; not stretchable; plain; snap-on type; white



**Item No.: 248-501/000-002**  
Mini-WSB marking card; as card; not stretchable; plain; snap-on type; yellow

#### 1.1.2.3 Marker carrier



**Item No.: 750-103**  
Group marker carrier

### 1.1.3 Shield termination

#### 1.1.3.1 Shield clamping saddles



**Item No.: 790-108**  
Shield clamping saddle; 11 mm wide; diameter of compatible conductor; 3 ... 8 mm



**Item No.: 790-208**  
Shield clamping saddle; 12.4 mm wide; 3 ... 8 mm



**Item No.: 790-116**  
Shield clamping saddle; 19 mm wide; diameter of compatible conductor; 7 ... 16 mm



**Item No.: 790-216**  
Shield clamping saddle; 21.8 mm wide; 6 ... 16 mm



**Item No.: 790-124**  
Shield clamping saddle; 27 mm wide; diameter of compatible conductor; 6 ... 24 mm



**Item No.: 790-220**  
Shield clamping saddle; 30 mm wide; 6 ... 20 mm



**Item No.: 790-140**  
Shield clamping saddle; diameter of compatible conductor

1.1.4 System enclosure

1.1.4.1 System enclosure



**Item No.: 850-825**  
IP65 enclosure; Aluminium (RAL 7032); WxHxD (160x100x160 mm); 9 x M12, 4 x M20



**Item No.: 850-826**  
IP65 enclosure; Aluminium (RAL 7032); WxHxD (240x100x160 mm); 4 x M20, 4 x M16, 14 x M12 cable grip



**Item No.: 850-827**  
IP65 enclosure; Aluminium (RAL 7032); WxHxD (320x100x160 mm); 4 x M20, 8 x M16, 17 x M12 cable grip



**Item No.: 850-828**  
IP65 enclosure; Aluminium (RAL 7032); WxHxD (480x100x160 mm); 4 x M20, 10 x M16, 35 x M12 cable grip



**Item No.: 850-826/002-000**  
IP65 enclosure; Aluminium (RAL 7035); WxHxD (240x100x160 mm); 4 x M20, 4 x M16, 14 x M12 cable grip



**Item No.: 850-827/002-000**  
IP65 enclosure; Aluminium (RAL 7035); WxHxD (320x100x160 mm); 4 x M20, 8 x M16, 17 x M12 cable grip



**Item No.: 850-828/002-000**  
IP65 enclosure; Aluminium (RAL 7035); WxHxD (480x100x160 mm); 4 x M20, 10 x M16, 35 x M12 cable grip



**Item No.: 850-834**  
IP65 enclosure; Polyester (RAL 7032); WxHxD (164x100x164 mm); 9 x M12, 4 x M20



**Item No.: 850-835**  
IP65 enclosure; Polyester (RAL 7032); WxHxD (244x100x164 mm); 4 x M20, 4 x M16, 14 x M12 cable grip



**Item No.: 850-836**  
IP65 enclosure; Polyester (RAL 7032); WxHxD (324x100x164 mm); 4 x M20, 8 x M16, 17 x M12 cable grip



**Item No.: 850-814/002-000**  
IP65 enclosure; Sheet steel (RAL 7035); WxHxD (200x120x200 mm); without flange plate



**Item No.: 850-815/002-000**  
IP65 enclosure; Sheet steel (RAL 7035); WxHxD (300x120x200 mm); without flange plate



**Item No.: 850-816/002-000**  
IP65 enclosure; Sheet steel (RAL 7035); WxHxD (400x120x200 mm); without flange plate



**Item No.: 850-817/002-000**  
IP65 enclosure; Sheet steel (RAL 7035); WxHxD (600x120x200 mm); without flange plate