

# Data Sheet | Item Number: 765-4104/100-000

4-Port IO-Link Master Class B; Profinet; DC 24 V / 2.0 A; 4xM12 connection; SlimLine

<https://www.wago.com/765-4104/100-000>

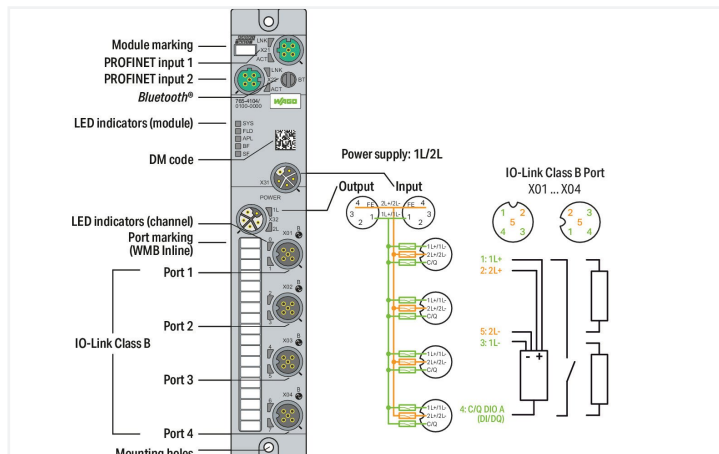

## Einsatzbereich:

Dezentrale Verarbeitung von Digitalen- und IO-Link-Signalen

Das Gerät dient zur Erfassung und Ansteuerung von IO-Link-fähigen digitalen Feldgeräten, z.B. von Sensoren, Aktoren und Hubs, die von einer übergeordneten Steuerung empfangen bzw. angesteuert werden. Das Gerät ist als Class B Master ausgelegt, und bietet 4 IO-Link Ports bzw. 4 digitale Ein-/Ausgänge.

## IO-Link:

Das Gerät verfügt über mehrere IO-Link-Kommunikationsschnittstellen für die Zusammenarbeit mit IO-Link Devices.

Die IO-Link-Schnittstelle ermöglicht den direkten Zugriff auf die Prozess- und Diagnosedaten und bietet die Möglichkeit, die Parameter der angeschlossenen Geräte während des Betriebs einzustellen.

Die IODD kann auch über den IODDfinder <https://ioddfinder.io-link.com> heruntergeladen werden.

## Technical data

### Fieldbus

Communication	PROFINET PROFINET IO device; 2-port switch, LLDP, MRP, SNMP
Connection technology: communication/fieldbus	2 x D-coded M12; 4-pole
Interface standard	10BASE-T/100BASE-TX; potential-free
Autonegotiation; autocrossover	Yes
PROFINET IO features	PROFINET IO device; 2-port switch, LLDP, MRP, SNMP

### Device functions

Parameter	Input filter Output current Temperature
Diagnostics	Undervoltage; overcurrent; overload; overtemperature
Device functions	Bluetooth® OPC UA server
Visualization	Android/iOS app Web server

### IO-Link master

IO-Link master classification	Class B; V1.1 specification
Port mode	IO-Link: autoconfig, manual, tool-based DI DO
Cycle time	400 µs (min.)
Operating mode	IO-Link master, DI or DO (adjustable for pin 4 per port); Supply voltage 2L (fixed for pin 2 per port)

### IO-Link ports

Number of digital inputs	4
Number of digital outputs	4
Connection technology: inputs/outputs	4 x A-coded M12; 5-pole
Signal type (voltage)	24 VDC
Input characteristic	high-side switching Type 3, per IEC 61131-2
Input filter	0.2 ... 20 ms
Output current (per channel)	2 A (typ.) for DO
Supply current per port	1L (pin 1): 1 A for IO-Link; 4 A (max.) for DIO; 2L (pin 2): 4 A (max.)

### Supply (module)

Connection technology: supply	2 x L-coded M12; 5-pole
Supply voltage	24 VDC (18 ... 31.2 V); 1L/2L
Current consumption (max.)	16000 mA
Current consumption (note)	per supply line; overload- and short-circuit-protected
Reverse voltage protection	Yes

### Physical data

Width	35 mm / 1.378 inches
Height	30 mm / 1.181 inches
Depth	210 mm / 8.268 inches

### Mechanical data

Weight	380 g
Conformity marking	CE

### Environmental requirements

Ambient temperature (operation)	-25 ... +70 °C
Ambient temperature (storage)	-40 ... +80 °C
Protection type	IP67
Protection class	III per EN 61140, IEC 61140, VDE 0140-1
Operating altitude	0 ... 2000 m / 0 ... 6562 ft
Pollution degree	3 (EN 60664-1)
Overvoltage category	II (EN 60664-1)
Relative humidity (without condensation)	95 %
Vibration resistance	5g per IEC 60068-2-6
Shock resistance	Short-term: 50g/11 ms/half-sine per IEC 60068-2-27; Long-term: 30g/6 ms/half-sine per IEC 60068-2-29
EMC immunity to interference	per EN 61000-6-2
EMC emission of interference	per EN 61000-6-4

### Commercial data

ETIM 8.0	EC001601
ETIM 7.0	EC001601
PU (SPU)	1 pcs
Packaging type	Box
Country of origin	DE
GTIN	4055143949880
Customs tariff number	85371098990

### Environmental Product Compliance

RoHS Compliance Status	Compliant, No Exemption
------------------------	-------------------------

## Approvals / Certificates

### General approvals



Approval	Standard	Certificate Name
KC National Radio Research Agency	Article 58-2, Clause 3	KC R-R-W43-FB765

## Downloads

### Environmental Product Compliance

#### Compliance Search

Environmental Product  
Compliance  
765-4104/100-000



## Documentation

### Manual

Product Manual 4-Port  
IO-Link Master Class B;  
Profinet

V 2.2.0  
19.07.2022

pdf  
8511.11 KB



### System Description

WAGO I/O System Field;  
General Product Infor-  
mation

pdf  
1009.23 KB



### Instruction Leaflet

I/O System Field packa-  
ge insert

15.12.2021

pdf  
1083.98 KB



## CAD/CAE-Data

### CAD data

2D/3D Models  
765-4104/100-000



### CAE data

EPLAN Data Portal  
765-4104/100-000



ZUKEN Portal  
765-4104/100-000



## Libraries

### Device Description File

750-916; GSD files of  
version 2.x for PROFI-  
NET/ series 750/753,  
765, 767 and 852

3.0  
15.01.2023

zip  
2582.40 KB



Gerätebeschreibungs-  
dateien 765-41xx,  
765-11xx, PROFINET

V1\_1\_0\_22

zip  
27.85 KB



## 1 Compatible Products

### 1.1 Required Accessories

#### 1.1.1 Cover

##### 1.1.1.1 Cover



**Item No.: 756-8103**

M12 protective cap; for unused plugs

**Item No.: 756-8102**

M12 protective cap; for unused sockets

### 1.1.2 Marking

#### 1.1.2.1 Marker



**Item No.: 2009-115**

WMB-Inline; for Smart Printer; 1500 pieces on roll; stretchable 5 - 5.2 mm; plain; snap-on type; white

#### 1.1.2.2 Marking strip



**Item No.: 2009-110**

Marking strips; for Smart Printer; on reel; not stretchable; plain; snap-on type; white

### 1.1.3 Tool

#### 1.1.3.1 Assembly tool



**Item No.: 206-701**

Torque wrench M8 and M12; Assembly kit

## 1.2 Optional Accessories

### 1.2.1 Cables and connectors

#### 1.2.1.1 Adapter



**Item No.: 756-9503/040-000**

Accessories; 4-pole

**Item No.: 756-9504/040-000**

Accessories; 4-pole

1.2.1.2 Configurable connector



**Item No.: 756-9701/050-000**  
Fitted pluggable connector; 5-pole, shielded; M12 plug, straight; IDC technology



**Item No.: 756-9711/050-000**  
Fitted pluggable connector; 5-pole, shielded; M12 socket, straight; IDC technology



**Item No.: 756-9205/050-000**  
Fitted pluggable connector; 5-pole; M12 plug, right angle; Spring



**Item No.: 756-9202/050-000**  
Fitted pluggable connector; 5-pole; M12 plug, straight, A-coded; Spring

1.2.1.3 Configurable shielded connector



**Item No.: 756-9501/040-000**  
Accessories; M12 plug, right angle; 4-pole



**Item No.: 756-9501/060-000**  
Fitted pluggable connector; 4-pole, shielded; M12 plug, straight, D-coded; Spring

1.2.1.4 Distribution connector



**Item No.: 756-9301/050-000**  
Accessories; 5-pole

1.2.1.5 ETHERNET/PROFINET cable



**Item No.: 756-1202/060-100**  
ETHERNET cable; M12D plug; angled; 4-pole; Length: 10 m



**Item No.: 756-1202/060-020**  
ETHERNET cable; M12D plug; angled; 4-pole; Length: 2 m



**Item No.: 756-1202/060-200**  
ETHERNET cable; M12D plug; angled; 4-pole; Length: 20 m



**Item No.: 756-1202/060-050**  
ETHERNET cable; M12D plug; angled; 4-pole; Length: 5 m



**Item No.: 756-1204/060-010**  
ETHERNET cable; M12D plug; angled; 4-pole; Length: 1 m



**Item No.: 756-1204/060-100**  
ETHERNET cable; M12D plug; angled; 4-pole; Length: 10 m



**Item No.: 756-1204/060-020**  
ETHERNET cable; M12D plug; angled; 4-pole; Length: 2 m



**Item No.: 756-1204/060-200**  
ETHERNET cable; M12D plug; angled; 4-pole; Length: 20 m



**Item No.: 756-1204/060-030**  
ETHERNET cable; M12D plug; angled; 4-pole; Length: 3 m



**Item No.: 756-1204/060-050**  
ETHERNET cable; M12D plug; angled; 4-pole; Length: 5 m



**Item No.: 756-1201/060-100**  
ETHERNET cable; M12D plug; straight; 4-pole; Length: 10 m



**Item No.: 756-1201/060-020**  
ETHERNET cable; M12D plug; straight; 4-pole; Length: 2 m



**Item No.: 756-1201/060-200**  
ETHERNET cable; M12D plug; straight; 4-pole; Length: 20 m



**Item No.: 756-1201/060-050**  
ETHERNET cable; M12D plug; straight; 4-pole; Length: 5 m



**Item No.: 756-1203/060-100**  
ETHERNET cable; M12D plug; straight; 4-pole; Length: 10 m



**Item No.: 756-1203/060-020**  
ETHERNET cable; M12D plug; straight; 4-pole; Length: 2 m



**Item No.: 756-1203/060-200**  
ETHERNET cable; M12D plug; straight; 4-pole; Length: 20 m



**Item No.: 756-1203/060-050**  
ETHERNET cable; M12D plug; straight; 4-pole; Length: 5 m

1.2.1.6 Power cable



**Item No.: 756-3504/050-100**  
Power cable; M12L plug; angled; 5-pole; Length: 10 m



**Item No.: 756-3504/050-150**  
Power cable; M12L plug; angled; 5-pole; Length: 15 m



**Item No.: 756-3504/050-020**  
Power cable; M12L plug; angled; 5-pole; Length: 2 m



**Item No.: 756-3504/050-050**  
Power cable; M12L plug; angled; 5-pole; Length: 5 m



**Item No.: 756-3504/050-075**  
Power cable; M12L plug; angled; 5-pole; Length: 7.5 m



**Item No.: 756-3503/050-100**  
Power cable; M12L plug; straight; 5-pole; Length: 10 m































**Item No.: 756-3503/050-150**  
Power cable; M12L plug; straight; 5-pole; Length: 15 m

















**Item No.: 756-3503/050-020**  
Power cable; M12L plug; straight; 5-pole; Length: 2 m

1.2.1.6 Power cable

 <b>Item No.: 756-3503/050-050</b> Power cable; M12L plug; straight; 5-pole; Length: 5 m	 <b>Item No.: 756-3503/050-075</b> Power cable; M12L plug; straight; 5-pole; Length: 7.5 m	 <b>Item No.: 756-3502/050-100</b> Power cable; M12L socket; angled; 5-pole; Length: 10 m	 <b>Item No.: 756-3502/050-150</b> Power cable; M12L socket; angled; 5-pole; Length: 15 m
 <b>Item No.: 756-3502/050-020</b> Power cable; M12L socket; angled; 5-pole; Length: 2 m	 <b>Item No.: 756-3502/050-050</b> Power cable; M12L socket; angled; 5-pole; Length: 5 m	 <b>Item No.: 756-3502/050-075</b> Power cable; M12L socket; angled; 5-pole; Length: 7.5 m	 <b>Item No.: 756-3506/050-003</b> Power cable; M12L socket; angled; M12L plug; angled; 5-pole; Length: 0.3 m
 <b>Item No.: 756-3506/050-005</b> Power cable; M12L socket; angled; M12L plug; angled; 5-pole; Length: 0.5 m	 <b>Item No.: 756-3506/050-010</b> Power cable; M12L socket; angled; M12L plug; angled; 5-pole; Length: 1 m	 <b>Item No.: 756-3506/050-100</b> Power cable; M12L socket; angled; M12L plug; angled; 5-pole; Length: 10 m	 <b>Item No.: 756-3506/050-150</b> Power cable; M12L socket; angled; M12L plug; angled; 5-pole; Length: 15 m
 <b>Item No.: 756-3506/050-020</b> Power cable; M12L socket; angled; M12L plug; angled; 5-pole; Length: 2 m	 <b>Item No.: 756-3506/050-050</b> Power cable; M12L socket; angled; M12L plug; angled; 5-pole; Length: 5 m	 <b>Item No.: 756-3506/050-075</b> Power cable; M12L socket; angled; M12L plug; angled; 5-pole; Length: 7.5 m	 <b>Item No.: 756-3501/050-100</b> Power cable; M12L socket; straight; 5-pole; Length: 10 m
 <b>Item No.: 756-3501/050-150</b> Power cable; M12L socket; straight; 5-pole; Length: 15 m	 <b>Item No.: 756-3501/050-020</b> Power cable; M12L socket; straight; 5-pole; Length: 2 m	 <b>Item No.: 756-3501/050-050</b> Power cable; M12L socket; straight; 5-pole; Length: 5 m	 <b>Item No.: 756-3501/050-075</b> Power cable; M12L socket; straight; 5-pole; Length: 7.5 m
 <b>Item No.: 756-3505/050-003</b> Power cable; M12L socket; straight; M12L plug; straight; 5-pole; Length: 0.3 m	 <b>Item No.: 756-3505/050-005</b> Power cable; M12L socket; straight; M12L plug; straight; 5-pole; Length: 0.5 m	 <b>Item No.: 756-3505/050-010</b> Power cable; M12L socket; straight; M12L plug; straight; 5-pole; Length: 1 m	 <b>Item No.: 756-3505/050-100</b> Power cable; M12L socket; straight; M12L plug; straight; 5-pole; Length: 10 m
 <b>Item No.: 756-3505/050-150</b> Power cable; M12L socket; straight; M12L plug; straight; 5-pole; Length: 15 m	 <b>Item No.: 756-3505/050-020</b> Power cable; M12L socket; straight; M12L plug; straight; 5-pole; Length: 2 m	 <b>Item No.: 756-3505/050-050</b> Power cable; M12L socket; straight; M12L plug; straight; 5-pole; Length: 5 m	 <b>Item No.: 756-3505/050-075</b> Power cable; M12L socket; straight; M12L plug; straight; 5-pole; Length: 7.5 m

1.2.1.7 Sensor/actuator cable

 <b>Item No.: 756-5312/050-015</b> Sensor/Actuator cable; M12A plug; angled; 5-pole; Length: 1.5 m	 <b>Item No.: 756-5312/050-100</b> Sensor/Actuator cable; M12A plug; angled; 5-pole; Length: 10 m	 <b>Item No.: 756-5312/050-050</b> Sensor/Actuator cable; M12A plug; angled; 5-pole; Length: 5 m	 <b>Item No.: 756-5311/050-015</b> Sensor/Actuator cable; M12A plug; straight; 5-pole; Length: 1.5 m
 <b>Item No.: 756-5311/050-100</b> Sensor/Actuator cable; M12A plug; straight; 5-pole; Length: 10 m	 <b>Item No.: 756-5311/050-050</b> Sensor/Actuator cable; M12A plug; straight; 5-pole; Length: 5 m	 <b>Item No.: 756-5404/050-010</b> Sensor/Actuator cable; M12A socket; angled; M12A plug; angled; 5-pole; Length: 1 m	 <b>Item No.: 756-5404/050-020</b> Sensor/Actuator cable; M12A socket; angled; M12A plug; angled; 5-pole; Length: 2 m
 <b>Item No.: 756-5403/050-010</b> Sensor/Actuator cable; M12A socket; angled; M12A plug; straight; 5-pole; Length: 1 m	 <b>Item No.: 756-5403/050-020</b> Sensor/Actuator cable; M12A socket; angled; M12A plug; straight; 5-pole; Length: 2 m	 <b>Item No.: 756-5402/050-010</b> Sensor/Actuator cable; M12A socket; straight; M12A plug; angled; 5-pole; Length: 1 m	 <b>Item No.: 756-5402/050-020</b> Sensor/Actuator cable; M12A socket; straight; M12A plug; angled; 5-pole; Length: 2 m
 <b>Item No.: 756-5401/050-010</b> Sensor/Actuator cable; M12A socket; straight; M12A plug; straight; 5-pole; Length: 1 m	 <b>Item No.: 756-5401/050-020</b> Sensor/Actuator cable; M12A socket; straight; M12A plug; straight; 5-pole; Length: 2 m		

Subject to changes. Please also observe the further product documentation!

Current addresses can be found at: [www.wago.com](http://www.wago.com)