

Data Sheet | Item Number: 765-4502/100-000

8-Port IO-Link Master Class B; EtherNet/IP; DC 24 V / 2.0 A; 8xM12 connection; Wi- deLine

<https://www.wago.com/765-4502/100-000>



Similar to illustration

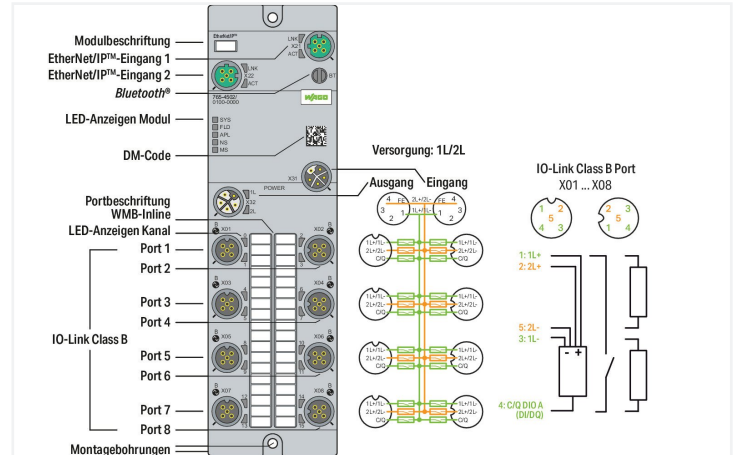

Einsatzbereich:

Dezentrale Verarbeitung von Digitalen- und IO-Link-Signalen

Das Gerät dient zur Erfassung und Ansteuerung von IO-Link-fähigen digitalen Feldgeräten, z.B. von Sensoren, Aktoren und Hubs, die von einer übergeordneten Steuerung empfangen bzw. angesteuert werden. Das Gerät ist als Class B Master ausgelegt, und bietet 8 IO-Link Ports bzw. 8 digitale Ein-/Ausgänge.

IO-Link:

Das Gerät verfügt über mehrere IO-Link-Kommunikationsschnittstellen für die Zusammenarbeit mit IO-Link Devices.

Die IO-Link-Schnittstelle ermöglicht den direkten Zugriff auf die Prozess- und Diagnosedaten und bietet die Möglichkeit, die Parameter der angeschlossenen Geräte während des Betriebs einzustellen.

Die IODD kann auch über den IODDfinder <https://ioddfinder.io-link.com> heruntergeladen werden.

Technical data

Fieldbus		Device functions	
Communication	EtherNet/IP™ BOOTP, DHCP, DLR	Parameter	Input filter Output current Temperature
Connection technology: communication/fieldbus	2 x D-coded M12; 4-pole	Diagnostics	Undervoltage; overcurrent; overload; overtemperature
Interface standard	10BASE-T/100BASE-TX; potential-free	Device functions	Bluetooth® OPC UA server
Autonegotiation; autocrossover	Yes	Visualization	Android/iOS app Web server
IO-Link master		IO-Link ports	
IO-Link master classification	Class B; V1.1 specification	Number of digital inputs	8
Port mode	IO-Link: autoconfig, manual, tool-based DI DO	Number of digital outputs	8
Cycle time	400 µs (min.)	Connection technology: inputs/outputs	8 x A-coded M12; 5-pole
Operating mode	IO-Link master, DI or DO (adjustable for pin 4 per port); Supply voltage 2L (fixed for pin 2 per port)	Signal type (voltage)	24 VDC
		Input characteristic	high-side switching Type 3, per IEC 61131-2
		Input filter	0.2 ... 20 ms
		Output current (per channel)	2 A (typ.) for DO
		Supply current per port	1L (Pin 1): 1 A for IO-Link; 4 A (max.) for DIO; 2L (Pin 2): 4 A (max.)

Supply (module)

Connection technology: supply	2 x L-coded M12; 5-pole
Supply voltage	24 VDC (18 ... 31.2 V); 1L/2L
Current consumption (max.)	16000 mA
Current consumption (note)	per supply line; overload- and short-circuit-protected
Reverse voltage protection	Yes

Physical data

Width	60 mm / 2.362 inches
Height	30 mm / 1.181 inches
Depth	210 mm / 8.268 inches

Mechanical data

Weight	610 g
Conformity marking	CE

Environmental requirements

Ambient temperature (operation)	-25 ... +70 °C
Ambient temperature (storage)	-40 ... +80 °C
Protection type	IP67
Protection class	III per EN 61140, IEC 61140, VDE 0140-1
Operating altitude	0 ... 2000 m / 0 ... 6562 ft
Pollution degree	3 (EN 60664-1)
Overvoltage category	II (EN 60664-1)
Relative humidity (without condensation)	95 %
Vibration resistance	5g per IEC 60068-2-6
Shock resistance	Short-term: 50g/11 ms/half-sine per IEC 60068-2-27; Long-term: 30g/6 ms/half-sine per IEC 60068-2-29
EMC immunity to interference	per EN 61000-6-2
EMC emission of interference	per EN 61000-6-4

Commercial data

ETIM 8.0	EC001601
ETIM 7.0	EC001601
PU (SPU)	1 pcs
Country of origin	DE
GTIN	4066966063202
Customs tariff number	85371098990

Environmental Product Compliance

RoHS Compliance Status	Compliant, No Exemption
------------------------	-------------------------

Approvals / Certificates

General approvals



Approval	Standard	Certificate Name
KC National Radio Research Agency	Article 58-2, Clause 3	KC R-R-W43-FB765

Downloads

Environmental Product Compliance

Compliance Search

Environmental Product Compliance 765-4502/100-000	↓
--	-------------------

Documentation

Manual

Product Manual 8-Port IO-Link Master Class B; EtherNet/IP	V 2.0.0 19.07.2022	pdf 9368.22 KB	↓
---	-----------------------	-------------------	-------------------

System Description

WAGO I/O System Field; General Product Information	pdf 1009.23 KB	↓
--	-------------------	-------------------

Instruction Leaflet

I/O System Field package insert	15.12.2021	pdf 1083.98 KB	↓
---------------------------------	------------	-------------------	-------------------

CAD/CAE-Data

CAD data

2D/3D Models 765-4502/100-000	↓
----------------------------------	-------------------

CAE data

EPLAN Data Portal 765-4502/100-000	↓
---------------------------------------	-------------------

Runtime Software

Firmware

0765-x5xx, Ethernet/IP IO-Field	V 04 02.02.2023	zip 1546.91 KB	↓
---------------------------------	--------------------	-------------------	-------------------

Libraries

Device Description File

750-915; EDS-Dateien for EthernetIP / Serie 750, 765 and 767	12 09.07.2021	zip 164.42 KB	
Gerätebeschreibungs- dateien 765-45xx, 765-15xx, EtherNet/IP	V1_1_0_22	zip 74.02 KB	

1 Compatible Products

1.1 Required Accessories

1.1.1 Cover

1.1.1.1 Cover



[Item No.: 756-8103](#)

M12 protective cap; for unused plugs

[Item No.: 756-8102](#)

M12 protective cap; for unused sockets

1.1.2 Marking

1.1.2.1 Marker



[Item No.: 2009-115](#)

WMB-Inline; for Smart Printer; 1500 pieces on roll; stretchable 5 - 5.2 mm; plain; snap-on type; white

1.1.2.2 Marking strip



[Item No.: 2009-110](#)

Marking strips; for Smart Printer; on reel; not stretchable; plain; snap-on type; white

1.1.3 Tool

1.1.3.1 Assembly tool



[Item No.: 206-701](#)

Torque wrench M8 and M12; Assembly kit

1.2 Optional Accessories

1.2.1 Cables and connectors

1.2.1.1 Configurable connector



Item No.: 756-9701/050-000
Fitted pluggable connector; 5-pole, shielded; M12 plug, straight; IDC technology



Item No.: 756-9711/050-000
Fitted pluggable connector; 5-pole, shielded; M12 socket, straight; IDC technology



Item No.: 756-9205/050-000
Fitted pluggable connector; 5-pole; M12 plug, right angle; Spring



Item No.: 756-9202/050-000
Fitted pluggable connector; 5-pole; M12 plug, straight, A-coded; Spring

1.2.1.2 Configurable shielded connector



Item No.: 756-9501/040-000
Accessories; M12 plug, right angle; 4-pole



Item No.: 756-9501/060-000
Fitted pluggable connector; 4-pole, shielded; M12 plug, straight, D-coded; Spring

1.2.1.3 Distribution connector



Item No.: 756-9301/050-000
Accessories; 5-pole

1.2.1.4 ETHERNET/PROFINET cable



Item No.: 756-1202/060-100
ETHERNET cable; M12D plug; angled; 4-pole; Length: 10 m



Item No.: 756-1202/060-020
ETHERNET cable; M12D plug; angled; 4-pole; Length: 2 m



Item No.: 756-1202/060-200
ETHERNET cable; M12D plug; angled; 4-pole; Length: 20 m



Item No.: 756-1202/060-050
ETHERNET cable; M12D plug; angled; 4-pole; Length: 5 m



Item No.: 756-1204/060-010
ETHERNET cable; M12D plug; angled; M12D plug; angled; 4-pole; Length: 1 m



Item No.: 756-1204/060-100
ETHERNET cable; M12D plug; angled; M12D plug; angled; 4-pole; Length: 10 m



Item No.: 756-1204/060-020
ETHERNET cable; M12D plug; angled; M12D plug; angled; 4-pole; Length: 2 m



Item No.: 756-1204/060-200
ETHERNET cable; M12D plug; angled; M12D plug; angled; 4-pole; Length: 20 m



Item No.: 756-1204/060-030
ETHERNET cable; M12D plug; angled; M12D plug; angled; 4-pole; Length: 3 m



Item No.: 756-1204/060-050
ETHERNET cable; M12D plug; angled; M12D plug; angled; 4-pole; Length: 5 m



Item No.: 756-1201/060-100
ETHERNET cable; M12D plug; straight; 4-pole; Length: 10 m



Item No.: 756-1201/060-020
ETHERNET cable; M12D plug; straight; 4-pole; Length: 2 m



Item No.: 756-1201/060-200
ETHERNET cable; M12D plug; straight; 4-pole; Length: 20 m



Item No.: 756-1201/060-050
ETHERNET cable; M12D plug; straight; 4-pole; Length: 5 m



Item No.: 756-1203/060-100
ETHERNET cable; M12D plug; straight; M12D plug; straight; 4-pole; Length: 10 m



Item No.: 756-1203/060-020
ETHERNET cable; M12D plug; straight; M12D plug; straight; 4-pole; Length: 2 m















Item No.: 756-1203/060-200
ETHERNET cable; M12D plug; straight; M12D plug; straight; 4-pole; Length: 20 m















Item No.: 756-1203/060-050
ETHERNET cable; M12D plug; straight; M12D plug; straight; 4-pole; Length: 5 m

1.2.1.5 Power cable

 Item No.: 756-3504/050-100 Power cable; M12L plug; angled; 5-pole; Length: 10 m	 Item No.: 756-3504/050-150 Power cable; M12L plug; angled; 5-pole; Length: 15 m	 Item No.: 756-3504/050-020 Power cable; M12L plug; angled; 5-pole; Length: 2 m	 Item No.: 756-3504/050-050 Power cable; M12L plug; angled; 5-pole; Length: 5 m
 Item No.: 756-3504/050-075 Power cable; M12L plug; angled; 5-pole; Length: 7.5 m	 Item No.: 756-3503/050-100 Power cable; M12L plug; straight; 5-pole; Length: 10 m	 Item No.: 756-3503/050-150 Power cable; M12L plug; straight; 5-pole; Length: 15 m	 Item No.: 756-3503/050-020 Power cable; M12L plug; straight; 5-pole; Length: 2 m
 Item No.: 756-3503/050-050 Power cable; M12L plug; straight; 5-pole; Length: 5 m	 Item No.: 756-3503/050-075 Power cable; M12L plug; straight; 5-pole; Length: 7.5 m	 Item No.: 756-3502/050-100 Power cable; M12L socket; angled; 5-pole; Length: 10 m	 Item No.: 756-3502/050-150 Power cable; M12L socket; angled; 5-pole; Length: 15 m
 Item No.: 756-3502/050-020 Power cable; M12L socket; angled; 5-pole; Length: 2 m	 Item No.: 756-3502/050-050 Power cable; M12L socket; angled; 5-pole; Length: 5 m	 Item No.: 756-3502/050-075 Power cable; M12L socket; angled; 5-pole; Length: 7.5 m	 Item No.: 756-3506/050-003 Power cable; M12L socket; angled; M12L plug; angled; 5-pole; Length: 0.3 m
 Item No.: 756-3506/050-005 Power cable; M12L socket; angled; M12L plug; angled; 5-pole; Length: 0.5 m	 Item No.: 756-3506/050-010 Power cable; M12L socket; angled; M12L plug; angled; 5-pole; Length: 1 m	 Item No.: 756-3506/050-100 Power cable; M12L socket; angled; M12L plug; angled; 5-pole; Length: 10 m	 Item No.: 756-3506/050-150 Power cable; M12L socket; angled; M12L plug; angled; 5-pole; Length: 15 m
 Item No.: 756-3506/050-020 Power cable; M12L socket; angled; M12L plug; angled; 5-pole; Length: 2 m	 Item No.: 756-3506/050-050 Power cable; M12L socket; angled; M12L plug; angled; 5-pole; Length: 5 m	 Item No.: 756-3506/050-075 Power cable; M12L socket; angled; M12L plug; angled; 5-pole; Length: 7.5 m	 Item No.: 756-3501/050-100 Power cable; M12L socket; straight; 5-pole; Length: 10 m
 Item No.: 756-3501/050-150 Power cable; M12L socket; straight; 5-pole; Length: 15 m	 Item No.: 756-3501/050-020 Power cable; M12L socket; straight; 5-pole; Length: 2 m	 Item No.: 756-3501/050-050 Power cable; M12L socket; straight; 5-pole; Length: 5 m	 Item No.: 756-3501/050-075 Power cable; M12L socket; straight; 5-pole; Length: 7.5 m
 Item No.: 756-3505/050-003 Power cable; M12L socket; straight; M12L plug; straight; 5-pole; Length: 0.3 m	 Item No.: 756-3505/050-005 Power cable; M12L socket; straight; M12L plug; straight; 5-pole; Length: 0.5 m	 Item No.: 756-3505/050-010 Power cable; M12L socket; straight; M12L plug; straight; 5-pole; Length: 1 m	 Item No.: 756-3505/050-100 Power cable; M12L socket; straight; M12L plug; straight; 5-pole; Length: 10 m
 Item No.: 756-3505/050-150 Power cable; M12L socket; straight; M12L plug; straight; 5-pole; Length: 15 m	 Item No.: 756-3505/050-020 Power cable; M12L socket; straight; M12L plug; straight; 5-pole; Length: 2 m	 Item No.: 756-3505/050-050 Power cable; M12L socket; straight; M12L plug; straight; 5-pole; Length: 5 m	 Item No.: 756-3505/050-075 Power cable; M12L socket; straight; M12L plug; straight; 5-pole; Length: 7.5 m

1.2.1.6 Sensor/actuator cable

 Item No.: 756-5312/050-015 Sensor/Actuator cable; M12A plug; angled; 5-pole; Length: 1.5 m	 Item No.: 756-5312/050-100 Sensor/Actuator cable; M12A plug; angled; 5-pole; Length: 10 m	 Item No.: 756-5312/050-050 Sensor/Actuator cable; M12A plug; angled; 5-pole; Length: 5 m	 Item No.: 756-5311/050-015 Sensor/Actuator cable; M12A plug; straight; 5-pole; Length: 1.5 m
 Item No.: 756-5311/050-100 Sensor/Actuator cable; M12A plug; straight; 5-pole; Length: 10 m	 Item No.: 756-5311/050-050 Sensor/Actuator cable; M12A plug; straight; 5-pole; Length: 5 m	 Item No.: 756-5404/050-010 Sensor/Actuator cable; M12A socket; angled; M12A plug; angled; 5-pole; Length: 1 m	 Item No.: 756-5404/050-020 Sensor/Actuator cable; M12A socket; angled; M12A plug; angled; 5-pole; Length: 2 m
 Item No.: 756-5403/050-010 Sensor/Actuator cable; M12A socket; angled; M12A plug; straight; 5-pole; Length: 1 m	 Item No.: 756-5403/050-020 Sensor/Actuator cable; M12A socket; angled; M12A plug; straight; 5-pole; Length: 2 m	 Item No.: 756-5402/050-010 Sensor/Actuator cable; M12A socket; straight; M12A plug; angled; 5-pole; Length: 1 m	 Item No.: 756-5402/050-020 Sensor/Actuator cable; M12A socket; straight; M12A plug; angled; 5-pole; Length: 2 m

1.2.1.6 Sensor/actuator cable



Item No.: 756-5401/050-010

Sensor/Actuator cable; M12A socket;
straight; M12A plug; straight; 5-pole;
Length: 1 m

Item No.: 756-5401/050-020

Sensor/Actuator cable; M12A socket;
straight; M12A plug; straight; 5-pole;
Length: 2 m