

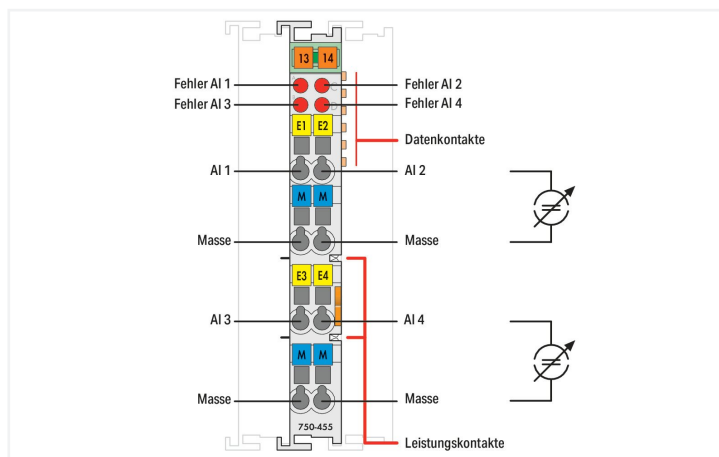

Color: ■ light gray

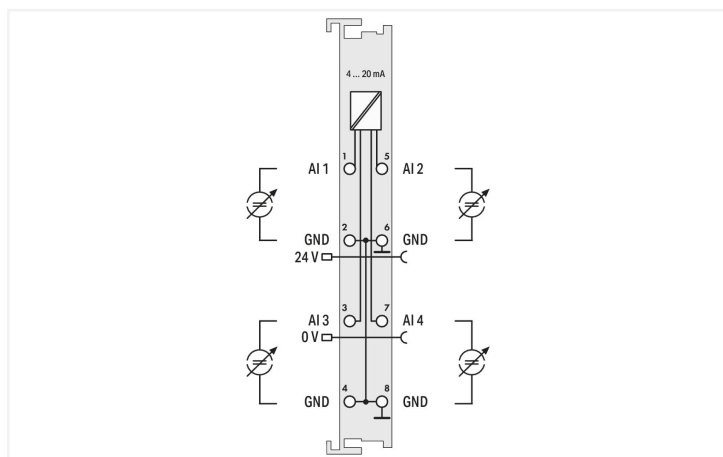
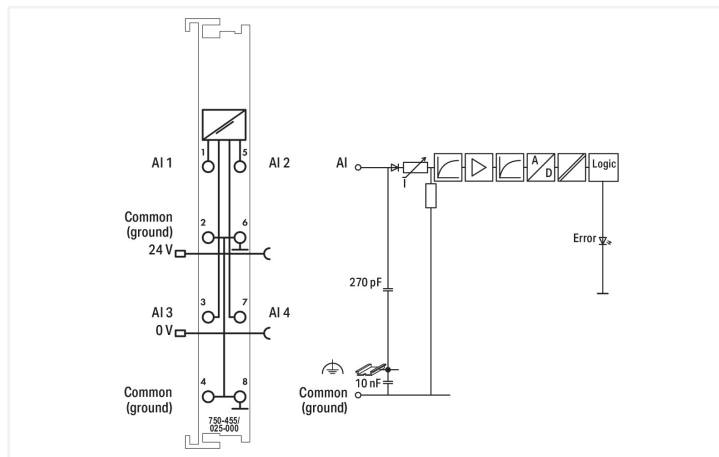

This analog input module processes standard 4–20 mA signals.
 The input signal is electrically isolated and is transmitted with a resolution of 12 bits.
 The internal system supply powers the module.
 The input channels of the module have a common ground potential.

Technical data

Number of analog inputs	4
Total number of channels (module)	4
Signal type	Current
Signal type (current)	4 ... 20 mADC
Sensor connection	4 x (2-wire)
Input voltage (max.)	32 V
Signal characteristics	Single-ended
Resolution [bit]	12 bits
Input resistance (max.)	100 Ω
Data width	4 x 16-bit data; 4 x 8-bit control/status (optional)
Conversion time (typ.)	10 ms
Measurement error (reference temperature)	25 °C
Measurement error, deviation (max.) from the upper-range value	0.1 %
Temperature error (max.) of the upper-range value	0.01 %/K
Supply voltage (system)	5 VDC; via data contacts
Current consumption (5 V system supply)	65 mA
Supply voltage (field)	24 VDC (-25 ... +30 %); via power jumper contacts (power supply via blade contact; transmission via spring contact)
Isolation	500 V system/field

Technical data

Indicators	LED (A-D) red: Error AI 1 ... AI 4
Number of incoming power jumper contacts	2
Number of outgoing power jumper contacts	2

Connection data

Connection technology: inputs/outputs	8 x CAGE CLAMP®
Connection type 1	Inputs/outputs
Solid conductor	0.08 ... 2.5 mm ² / 28 ... 14 AWG
Fine-stranded conductor	0.08 ... 2.5 mm ² / 28 ... 14 AWG
Strip length	8 ... 9 mm / 0.31 ... 0.35 inches

Physical data

Width	12 mm / 0.472 inches
Height	100 mm / 3.937 inches
Depth	69.8 mm / 2.748 inches
Depth from upper-edge of DIN-rail	62.6 mm / 2.465 inches

Mechanical data

Mounting type	DIN-35 rail
---------------	-------------

Material data

Color	light gray
Housing material	Polycarbonate; polyamide 6.6
Fire load	1.264 MJ
Weight	50.9 g
Conformity marking	CE

Environmental requirements

Ambient temperature (operation)	-20 ... +60 °C
Ambient temperature (storage)	-40 ... +85 °C
Protection type	IP20
Pollution degree	2 per IEC 61131-2
Operating altitude	0 ... 2000 m / 0 ... 6562 ft
Mounting position	horizontal (standing/lying); vertical
Relative humidity (without condensation)	95 %
Relative humidity (with condensation)	Short-term condensation per Class 3K6/IEC EN 60721-3-3 and E-DIN 40046-721-3, accounting for a temperature range of -20 to +60 °C (except for wind-driven precipitation, water and ice formation)
Vibration resistance	4g per IEC 60068-2-6
Shock resistance	15g per IEC 60068-2-27
EMC immunity to interference	per EN 61000-6-2, marine applications
EMC emission of interference	per EN 61000-6-4, marine applications
Exposure to pollutants	per IEC 60068-2-42 and IEC 60068-2-43
Permissible H ₂ S contaminant concentration at a relative humidity 75 %	10 ppm
Permissible SO ₂ contaminant concentration at a relative humidity 75 %	25 ppm

Commercial data

Product Group	15 (I/O System)
eCl@ss 10.0	27-24-26-01
eCl@ss 9.0	27-24-26-01
ETIM 8.0	EC001596
ETIM 7.0	EC001596
PU (SPU)	1 pcs
Packaging type	Box
Country of origin	DE
GTIN	4045454543037
Customs tariff number	85389099990

Environmental Product Compliance

CAS-No.	1303-86-2 1317-36-8 7439-92-1
REACH Candidate List Substance	Diboron trioxide Lead Lead monoxide
RoHS Compliance Status	Compliant,With Exemption
RoHS Exemption	7(a) 7(c)-I
SCIP notification number (Austria)	7b250c65-6466-42ce-921a-0d2868205564
SCIP notification number (Belgium)	4b090207-5679-472f-80db-1173b958d76a
SCIP notification number (Bulgaria)	e83f1a93-c2eb-4b13-9f09-f559690feb0
SCIP notification number (Czech Republic)	086460f7-8793-4605-ad06-73d7b42b0b46
SCIP notification number (Denmark)	aaa81d75-bd29-4e20-b6b9-37b395c01a5a
SCIP notification number (Finland)	d7dfcce0-5d6d-4498-8487-7577554cf540
SCIP notification number (France)	e2bdec67-149e-4113-8995-c34313feacff
SCIP notification number (Germany)	a68292cb-9f61-4bb0-969b-4b04656b8eae
SCIP notification number (Hungary)	14ac9abf-377d-43ca-9666-7cfdcb411678
SCIP notification number (Italy)	0810cdfb-799a-43fe-86fb-fda9913ac9f5
SCIP notification number (Netherlands)	e9a595db-cd17-4a40-94cf-fce9855dd091
SCIP notification number (Poland)	4e0ad809-b262-4ba2-a0c1-03fcedf5b5eb
SCIP notification number (Romania)	a8b3059b-bd4b-4ccd-b15e-848d00f12685
SCIP notification number (Sweden)	13858077-7415-4a5a-8751-30f768081c0f

Approvals / Certificates

General approvals



Approval	Standard	Certificate Name
EAC Brjansker Zertifizierungs- stelle	TP TC 020/2011	EAC RU C-DE.AM02. B.00087/19
KC National Radio Research Agency	Article 58-2, Clause 3	MSIP-REM-W43-AIM750
UL Underwriters Laboratories Inc. (ORDINARY LOCATI- ONS)	UL 508	E175199 Sec.1

Declarations of conformity and manufacturer's declarations

Approval	Standard	Certificate Name
EU-Declaration of Confor- mity WAGO GmbH & Co. KG	-	-
UK-Declaration of Confor- mity WAGO GmbH & Co. KG	-	-

Approvals for marine applications



Approval	Standard	Certificate Name
ABS American Bureau of Ship- ping	-	22-2227356-PDA
BSH Bundesamt fuer See- schifffahrt und Hydrogra- phie	-	1104
DNV DNV Germany GmbH	DNV-CG-0339,Aug.2021	TAA00001J4
LR Lloyds Register	-	LR22194334TA
PRS Polski Rejestr Statków	-	TE/2237/880590/19

Approvals for hazardous areas



Approval	Standard	Certificate Name
ATEX TUEV Nord Cert GmbH	EN 60079-0	TUEV14ATEX148929X (II 3 G Ex ec IIC T4 Gc)
CCCEX CQST/CNEx	CNCA-C23-01	2020312310000213 (Ex ec IIC T4 Gc)
EAC Brjansker Zertifizierungs- stelle	TP TC 012/2011	EAC RU C-DE.AM02. B.00163/19 (2Ex e IIC T4 Gc X)
IECEX TUEV Nord Cert GmbH	IEC 60079-0	IECEX TUN 14.0035 X (Ex ec IIC T4 Gc)
INMETRO TUV Rheinland do Brasil Ltda.	IEC 60079-0	BR-Ex_TUV 12.1297 X
UKEx WAGO GmbH & Co. KG	EN 60079-0	UKCA_WA GO22UKEX003X_ec
UL Underwriters Laboratories Inc. (HAZARDOUS LOCA- TIONS)	UL 121201	E198726 Sec.1

Downloads

Environmental Product Compliance

Compliance Search

Environmental Product
Compliance
750-455/025-000



Documentation

Manual

Product Manual 4- channel, 4-20mA, sin- gle-ended	V 2.0.1 14.07.2023	pdf 2851.87 KB	
System Manual WAGO I/O System 750/753	V 3.3.3 29.08.2023	pdf 8512.61 KB	
System Manual Series 750/753			

System Description

750/753 Series I/O- System – General Pro- duct Information	pdf 953.35 KB	
Overview on WAGO-I/ O-SYSTEM 750 appro- vals	pdf 770.48 KB	

Bid Text

750-455/025-000	19.02.2019	xml 4.32 KB	
750-455/025-000	17.10.2017	doc 29.00 KB	

Instruction Leaflet

CCC Ex (Additional in- formation)	26.04.2023	pdf 159.76 KB	
--------------------------------------	------------	------------------	--

CAD/CAE-Data

CAD data	CAE data
2D/3D Models 750-455/025-000	EPLAN Data Portal 750-455/025-000
	WSCAD Universe 750-455/025-000
	ZUKEN Portal 750-455/025-000

Device Files

Device Driver			
WAGO USB Service Kabel Treiber / Serie 750 und 857	6.5.3.0 10.09.2014	zip 4721.96 KB	

1 Compatible Products

1.1 Optional Accessories

1.1.1 DIN-rail

1.1.1.1 Mounting accessories



Item No.: 210-196
 Aluminum carrier rail; 35 x 8.2 mm; 1.6 mm thick; 2 m long; unslotted; similar to EN 60715; silver-colored



Item No.: 210-198
 Copper carrier rail; 35 x 15 mm; 2.3 mm thick; 2 m long; unslotted; according to EN 60715; copper-colored



Item No.: 210-508
 Steel carrier rail; 35 x 15 mm; 1.5 mm thick; 2 m long; slotted; galvanized; similar to EN 60715; silver-colored



Item No.: 210-197
 Steel carrier rail; 35 x 15 mm; 1.5 mm thick; 2 m long; slotted; similar to EN 60715; silver-colored



Item No.: 210-506
 Steel carrier rail; 35 x 15 mm; 1.5 mm thick; 2 m long; unslotted; galvanized; similar to EN 60715; silver-colored



Item No.: 210-114
 Steel carrier rail; 35 x 15 mm; 1.5 mm thick; 2 m long; unslotted; similar to EN 60715; silver-colored



Item No.: 210-118
 Steel carrier rail; 35 x 15 mm; 2.3 mm thick; 2 m long; unslotted; according to EN 60715; silver-colored



Item No.: 210-115
 Steel carrier rail; 35 x 7.5 mm; 1 mm thick; 2 m long; slotted; according to EN 60715; "Hole width 18 mm; silver-colored



Item No.: 210-112
 Steel carrier rail; 35 x 7.5 mm; 1 mm thick; 2 m long; slotted; according to EN 60715; "Hole width 25 mm; silver-colored



Item No.: 210-504
 Steel carrier rail; 35 x 7.5 mm; 1 mm thick; 2 m long; slotted; galvanized; according to EN 60715; silver-colored



Item No.: 210-113
 Steel carrier rail; 35 x 7.5 mm; 1 mm thick; 2 m long; unslotted; according to EN 60715; silver-colored



Item No.: 210-505
 Steel carrier rail; 35 x 7.5 mm; 1 mm thick; 2 m long; unslotted; galvanized; according to EN 60715; silver-colored



















1.1.2 Marking

1.1.2.1 Group marker carrier



Item No.: 750-106
 Group marker carrier

1.1.2.2 Marker

 Item No.: 750-100 Marker card; as a DIN A4 sheet; plain	 Item No.: 2009-145/000-006 Mini-WSB Inline; for Smart Printer; 1700 pieces on roll; stretchable 5 - 5.2 mm; plain; snap-on type; blue	 Item No.: 2009-145/000-007 Mini-WSB Inline; for Smart Printer; 1700 pieces on roll; stretchable 5 - 5.2 mm; plain; snap-on type; gray	 Item No.: 2009-145/000-023 Mini-WSB Inline; for Smart Printer; 1700 pieces on roll; stretchable 5 - 5.2 mm; plain; snap-on type; green
 Item No.: 2009-145/000-012 Mini-WSB Inline; for Smart Printer; 1700 pieces on roll; stretchable 5 - 5.2 mm; plain; snap-on type; orange	 Item No.: 2009-145/000-005 Mini-WSB Inline; for Smart Printer; 1700 pieces on roll; stretchable 5 - 5.2 mm; plain; snap-on type; red	 Item No.: 2009-145/000-024 Mini-WSB Inline; for Smart Printer; 1700 pieces on roll; stretchable 5 - 5.2 mm; plain; snap-on type; violet	 Item No.: 2009-145 Mini-WSB Inline; for Smart Printer; 1700 pieces on roll; stretchable 5 - 5.2 mm; plain; snap-on type; white
 Item No.: 2009-145/000-002 Mini-WSB marking card; as card; not stretchable; plain; snap-on type; yellow	 Item No.: 248-501/000-006 Mini-WSB marking card; as card; not stretchable; plain; snap-on type; blue	 Item No.: 248-501/000-007 Mini-WSB marking card; as card; not stretchable; plain; snap-on type; gray	 Item No.: 248-501/000-023 Mini-WSB marking card; as card; not stretchable; plain; snap-on type; green
 Item No.: 248-501/000-017 Mini-WSB marking card; as card; not stretchable; plain; snap-on type; light green	 Item No.: 248-501/000-012 Mini-WSB marking card; as card; not stretchable; plain; snap-on type; orange	 Item No.: 248-501/000-005 Mini-WSB marking card; as card; not stretchable; plain; snap-on type; red	 Item No.: 248-501/000-024 Mini-WSB marking card; as card; not stretchable; plain; snap-on type; violet
 Item No.: 248-501 Mini-WSB marking card; as card; not stretchable; plain; snap-on type; white	 Item No.: 248-501/000-002 Mini-WSB marking card; as card; not stretchable; plain; snap-on type; yellow		

1.1.2.3 Marker carrier

 Item No.: 750-103 Group marker carrier

1.1.3 Shield termination

1.1.3.1 Shield clamping saddles

 Item No.: 790-108 Shield clamping saddle; 11 mm wide; diameter of compatible conductor; 3 ... 8 mm	 Item No.: 790-208 Shield clamping saddle; 12.4 mm wide; 3 ... 8 mm	 Item No.: 790-116 Shield clamping saddle; 19 mm wide; diameter of compatible conductor; 7 ... 16 mm	 Item No.: 790-216 Shield clamping saddle; 21.8 mm wide; 6 ... 16 mm
 Item No.: 790-124 Shield clamping saddle; 27 mm wide; diameter of compatible conductor; 6 ... 24 mm	 Item No.: 790-220 Shield clamping saddle; 30 mm wide; 6 ... 20 mm	 Item No.: 790-140 Shield clamping saddle; diameter of compatible conductor	

1.1.4 System enclosure

1.1.4.1 System enclosure

**Item No.: 850-825**

IP65 enclosure; Aluminium (RAL 7032);
WxHxD (160x100x160 mm); 9 x M12, 4 x
M20

**Item No.: 850-826**

IP65 enclosure; Aluminium (RAL 7032);
WxHxD (240x100x160 mm); 4 x M20, 4 x
M16, 14 x M12 cable grip

**Item No.: 850-827**

IP65 enclosure; Aluminium (RAL 7032);
WxHxD (320x100x160 mm); 4 x M20, 8 x
M16, 17 x M12 cable grip

**Item No.: 850-828**

IP65 enclosure; Aluminium (RAL 7032);
WxHxD (480x100x160 mm); 4 x M20, 10 x
M16, 35 x M12 cable grip

**Item No.: 850-826/002-000**

IP65 enclosure; Aluminium (RAL 7035);
WxHxD (240x100x160 mm); 4 x M20, 4 x
M16, 14 x M12 cable grip

**Item No.: 850-827/002-000**

IP65 enclosure; Aluminium (RAL 7035);
WxHxD (320x100x160 mm); 4 x M20, 8 x
M16, 17 x M12 cable grip

**Item No.: 850-828/002-000**

IP65 enclosure; Aluminium (RAL 7035);
WxHxD (480x100x160 mm); 4 x M20, 10 x
M16, 35 x M12 cable grip

**Item No.: 850-834**

IP65 enclosure; Polyester (RAL 7032); Wx-
HxD (164x100x164 mm); 9 x M12, 4 x M20

**Item No.: 850-835**

IP65 enclosure; Polyester (RAL 7032); Wx-
HxD (244x100x164 mm); 4 x M20, 4 x
M16, 14 x M12 cable grip

**Item No.: 850-836**

IP65 enclosure; Polyester (RAL 7032);
WxHxD (324x100x164 mm); 4 x M20, 8 x
M16, 17 x M12 cable grip

**Item No.: 850-814/002-000**

IP65 enclosure; Sheet steel (RAL 7035);
WxHxD (200x120x200 mm); without flan-
ge plate

**Item No.: 850-815/002-000**

IP65 enclosure; Sheet steel (RAL 7035);
WxHxD (300x120x200 mm); without flan-
ge plate

**Item No.: 850-816/002-000**

IP65 enclosure; Sheet steel (RAL 7035);
WxHxD (400x120x200 mm); without flan-
ge plate

**Item No.: 850-817/002-000**

IP65 enclosure; Sheet steel (RAL 7035);
WxHxD (600x120x200 mm); without flan-
ge plate