

Data Sheet | Item Number: 750-460/000-005
4-channel analog input; For Ni1000/RTD resistance sensors

<https://www.wago.com/750-460/000-005>

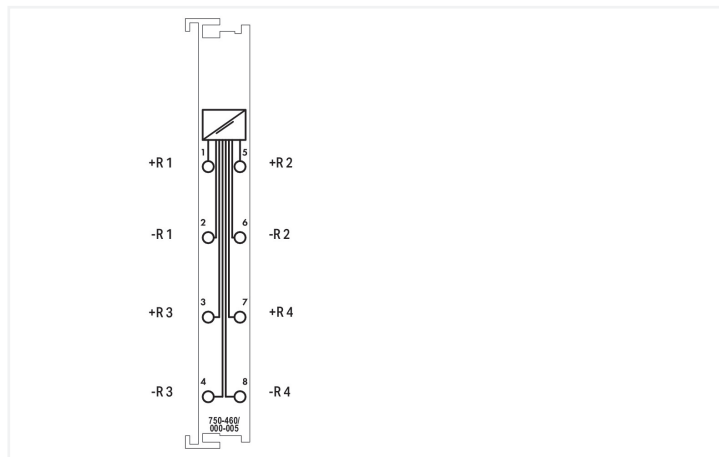

Color: ■ light gray

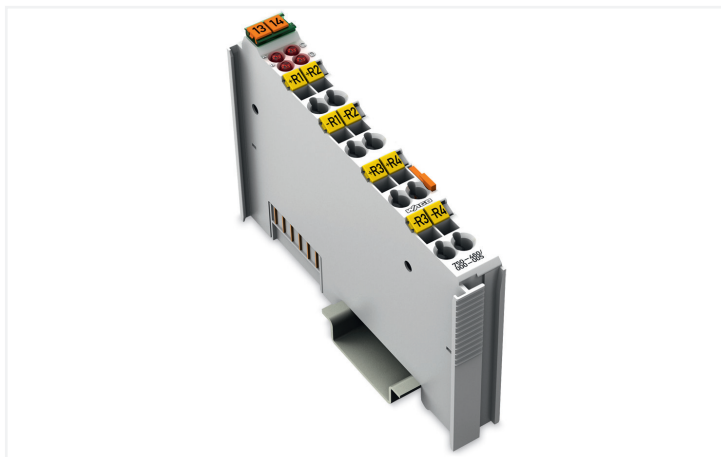
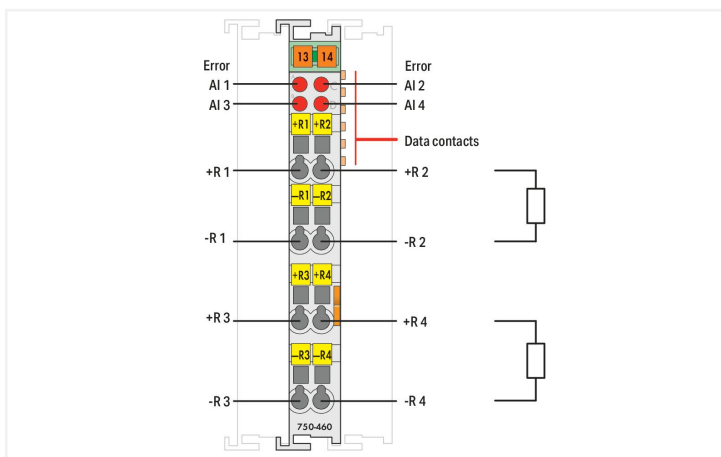

This analog input module directly connects to Ni resistance sensors.

Two-wire sensors can be connected.

The module automatically linearizes the entire temperature range. A sensor error (short circuit, line break or measurement range overflow) is indicated by a red LED.

Technical data

Number of analog inputs	4
Total number of channels (module)	4
Signal type	Resistance measurement
Sensor connection	4 x (2-wire)
Data width	4 x 16-bit data; 4 x 8-bit control/status (optional)
Resolution (over entire range)	0.1 °C
Conversion time (typ.)	250 ms
Measurement error (reference temperature)	25 °C
Measurement error, deviation (max.) from the upper-range value	0.2 %
Temperature error (max.) of the upper-range value	0.01 %/K
Measuring current (typ.)	0.5 mA
Sensor types	Ni1000 TK6180
Temperature range	-60 ... +250 °C
Supply voltage (system)	5 VDC; via data contacts
Current consumption (5 V system supply)	65 mA
Isolation	500 V system/field
Indicators	LED (A-D) red: Error AI 1 ... AI 4

Connection data

Connection technology: inputs/outputs	8 x CAGE CLAMP®
Connection type 1	Inputs/outputs
Solid conductor	0.08 ... 2.5 mm ² / 28 ... 14 AWG
Fine-stranded conductor	0.08 ... 2.5 mm ² / 28 ... 14 AWG
Strip length	8 ... 9 mm / 0.31 ... 0.35 inches

Physical data

Width	12 mm / 0.472 inches
Height	100 mm / 3.937 inches
Depth	69.8 mm / 2.748 inches
Depth from upper-edge of DIN-rail	62.6 mm / 2.465 inches

Mechanical data

Mounting type	DIN-35 rail
---------------	-------------

Material data

Color	light gray
Housing material	Polycarbonate; polyamide 6.6
Fire load	0.085 MJ
Weight	51.8 g
Conformity marking	CE

Environmental requirements

Ambient temperature (operation)	0 ... +55 °C
Ambient temperature (storage)	-40 ... +85 °C
Protection type	IP20
Pollution degree	2 per IEC 61131-2
Operating altitude	0 ... 2000 m / 0 ... 6562 ft
Mounting position	horizontal (standing/lying); vertical
Relative humidity (without condensation)	95 %
Vibration resistance	per IEC 60068-2-6
Shock resistance	15g per IEC 60068-2-27
EMC immunity to interference	per EN 61000-6-2
EMC emission of interference	per EN 61000-6-4
Exposure to pollutants	per IEC 60068-2-42 and IEC 60068-2-43
Permissible H ₂ S contaminant concentration at a relative humidity 75 %	10 ppm
Permissible SO ₂ contaminant concentration at a relative humidity 75 %	25 ppm

Commercial data

Product Group	15 (I/O System)
eCl@ss 10.0	27-24-26-01
eCl@ss 9.0	27-24-26-01
ETIM 8.0	EC001596
ETIM 7.0	EC001596
PU (SPU)	1 pcs
Packaging type	Box
Country of origin	DE
GTIN	4045454848965
Customs tariff number	85389099990

Environmental Product Compliance

RoHS Compliance Status	Compliant, No Exemption
------------------------	-------------------------

Approvals / Certificates

General approvals **Declarations of conformity and manufacturer's declarations**



Approval	Standard	Certificate Name
EAC Brjansker Zertifizierungsstelle	TP TC 020/2011	EAC RU C-DE.AM02. B.00087/19
KC National Radio Research Agency	Article 58-2, Clause 3	MSIP-REM-W43-AIM750
UL Underwriters Laboratories Inc. (ORDINARY LOCATIONS)	UL 508	E175199 Sec.1

Approval	Standard	Certificate Name
EU-Declaration of Conformity WAGO GmbH & Co. KG	-	-
UK-Declaration of Conformity WAGO GmbH & Co. KG	-	-

Downloads

Environmental Product Compliance

Compliance Search

Environmental Product Compliance 750-460/000-005	↓
---	-------------------

Documentation

Manual

Product Manual 4-channel, resistance sensors	V 1.1.0	pdf 1272.93 KB	↓
System Manual WAGO I/O System 750/753	V 3.3.3 29.08.2023	pdf 8512.61 KB	↓
System Manual Series 750/753			↓

System Description

750/753 Series I/O-System – General Product Information	pdf 953.35 KB	↓
Overview on WAGO-I/O-SYSTEM 750 approvals	pdf 770.48 KB	↓

Bid Text

750-460/000-005	19.02.2019	xml 4.33 KB	↓
750-460/000-005	20.10.2017	doc 28.50 KB	↓

CAD/CAE-Data

CAD data	CAE data
2D/3D Models 750-460/000-005	EPLAN Data Portal 750-460/000-005
	WSCAD Universe 750-460/000-005
	ZUKEN Portal 750-460/000-005

Device Files

Device Driver			
WAGO USB Service Kabel Treiber / Serie 750 und 857	6.5.3.0 10.09.2014	zip 4721.96 KB	

1 Compatible Products

1.1 Optional Accessories

1.1.1 DIN-rail

1.1.1.1 Mounting accessories



Item No.: 210-196
 Aluminum carrier rail; 35 x 8.2 mm; 1.6 mm thick; 2 m long; unslotted; similar to EN 60715; silver-colored



Item No.: 210-198
 Copper carrier rail; 35 x 15 mm; 2.3 mm thick; 2 m long; unslotted; according to EN 60715; copper-colored



Item No.: 210-508
 Steel carrier rail; 35 x 15 mm; 1.5 mm thick; 2 m long; slotted; galvanized; similar to EN 60715; silver-colored



Item No.: 210-197
 Steel carrier rail; 35 x 15 mm; 1.5 mm thick; 2 m long; slotted; similar to EN 60715; silver-colored



Item No.: 210-506
 Steel carrier rail; 35 x 15 mm; 1.5 mm thick; 2 m long; unslotted; galvanized; similar to EN 60715; silver-colored



Item No.: 210-114
 Steel carrier rail; 35 x 15 mm; 1.5 mm thick; 2 m long; unslotted; similar to EN 60715; silver-colored



Item No.: 210-118
 Steel carrier rail; 35 x 15 mm; 2.3 mm thick; 2 m long; unslotted; according to EN 60715; silver-colored



Item No.: 210-115
 Steel carrier rail; 35 x 7.5 mm; 1 mm thick; 2 m long; slotted; according to EN 60715; "Hole width 18 mm; silver-colored



Item No.: 210-112
 Steel carrier rail; 35 x 7.5 mm; 1 mm thick; 2 m long; slotted; according to EN 60715; "Hole width 25 mm; silver-colored



Item No.: 210-504
 Steel carrier rail; 35 x 7.5 mm; 1 mm thick; 2 m long; slotted; galvanized; according to EN 60715; silver-colored



Item No.: 210-113
 Steel carrier rail; 35 x 7.5 mm; 1 mm thick; 2 m long; unslotted; according to EN 60715; silver-colored



Item No.: 210-505
 Steel carrier rail; 35 x 7.5 mm; 1 mm thick; 2 m long; unslotted; galvanized; according to EN 60715; silver-colored



















1.1.2 Marking

1.1.2.1 Group marker carrier



Item No.: 750-106
 Group marker carrier

1.1.2.2 Marker

 Item No.: 750-100 Marker card; as a DIN A4 sheet; plain	 Item No.: 2009-145/000-006 Mini-WSB Inline; for Smart Printer; 1700 pieces on roll; stretchable 5 - 5.2 mm; plain; snap-on type; blue	 Item No.: 2009-145/000-007 Mini-WSB Inline; for Smart Printer; 1700 pieces on roll; stretchable 5 - 5.2 mm; plain; snap-on type; gray	 Item No.: 2009-145/000-023 Mini-WSB Inline; for Smart Printer; 1700 pieces on roll; stretchable 5 - 5.2 mm; plain; snap-on type; green
 Item No.: 2009-145/000-012 Mini-WSB Inline; for Smart Printer; 1700 pieces on roll; stretchable 5 - 5.2 mm; plain; snap-on type; orange	 Item No.: 2009-145/000-005 Mini-WSB Inline; for Smart Printer; 1700 pieces on roll; stretchable 5 - 5.2 mm; plain; snap-on type; red	 Item No.: 2009-145/000-024 Mini-WSB Inline; for Smart Printer; 1700 pieces on roll; stretchable 5 - 5.2 mm; plain; snap-on type; violet	 Item No.: 2009-145 Mini-WSB Inline; for Smart Printer; 1700 pieces on roll; stretchable 5 - 5.2 mm; plain; snap-on type; white
 Item No.: 2009-145/000-002 Mini-WSB Inline; for Smart Printer; 1700 pieces on roll; stretchable 5 - 5.2 mm; plain; snap-on type; yellow	 Item No.: 248-501/000-006 Mini-WSB marking card; as card; not stretchable; plain; snap-on type; blue	 Item No.: 248-501/000-007 Mini-WSB marking card; as card; not stretchable; plain; snap-on type; gray	 Item No.: 248-501/000-023 Mini-WSB marking card; as card; not stretchable; plain; snap-on type; green
 Item No.: 248-501/000-017 Mini-WSB marking card; as card; not stretchable; plain; snap-on type; light green	 Item No.: 248-501/000-012 Mini-WSB marking card; as card; not stretchable; plain; snap-on type; orange	 Item No.: 248-501/000-005 Mini-WSB marking card; as card; not stretchable; plain; snap-on type; red	 Item No.: 248-501/000-024 Mini-WSB marking card; as card; not stretchable; plain; snap-on type; violet
 Item No.: 248-501 Mini-WSB marking card; as card; not stretchable; plain; snap-on type; white	 Item No.: 248-501/000-002 Mini-WSB marking card; as card; not stretchable; plain; snap-on type; yellow		

1.1.2.3 Marker carrier

 Item No.: 750-103 Group marker carrier

1.1.3 Shield termination

1.1.3.1 Shield clamping saddles

 Item No.: 790-108 Shield clamping saddle; 11 mm wide; diameter of compatible conductor; 3 ... 8 mm	 Item No.: 790-208 Shield clamping saddle; 12.4 mm wide; 3 ... 8 mm	 Item No.: 790-116 Shield clamping saddle; 19 mm wide; diameter of compatible conductor; 7 ... 16 mm	 Item No.: 790-216 Shield clamping saddle; 21.8 mm wide; 6 ... 16 mm
 Item No.: 790-124 Shield clamping saddle; 27 mm wide; diameter of compatible conductor; 6 ... 24 mm	 Item No.: 790-220 Shield clamping saddle; 30 mm wide; 6 ... 20 mm	 Item No.: 790-140 Shield clamping saddle; diameter of compatible conductor	

1.1.4 System enclosure

1.1.4.1 System enclosure

**Item No.: 850-825**

IP65 enclosure; Aluminium (RAL 7032);
WxHxD (160x100x160 mm); 9 x M12, 4 x
M20

**Item No.: 850-826**

IP65 enclosure; Aluminium (RAL 7032);
WxHxD (240x100x160 mm); 4 x M20, 4 x
M16, 14 x M12 cable grip

**Item No.: 850-827**

IP65 enclosure; Aluminium (RAL 7032);
WxHxD (320x100x160 mm); 4 x M20, 8 x
M16, 17 x M12 cable grip

**Item No.: 850-828**

IP65 enclosure; Aluminium (RAL 7032);
WxHxD (480x100x160 mm); 4 x M20, 10 x
M16, 35 x M12 cable grip

**Item No.: 850-826/002-000**

IP65 enclosure; Aluminium (RAL 7035);
WxHxD (240x100x160 mm); 4 x M20, 4 x
M16, 14 x M12 cable grip

**Item No.: 850-827/002-000**

IP65 enclosure; Aluminium (RAL 7035);
WxHxD (320x100x160 mm); 4 x M20, 8 x
M16, 17 x M12 cable grip

**Item No.: 850-828/002-000**

IP65 enclosure; Aluminium (RAL 7035);
WxHxD (480x100x160 mm); 4 x M20, 10 x
M16, 35 x M12 cable grip

**Item No.: 850-834**

IP65 enclosure; Polyester (RAL 7032); Wx-
HxD (164x100x164 mm); 9 x M12, 4 x M20

**Item No.: 850-835**

IP65 enclosure; Polyester (RAL 7032); Wx-
HxD (244x100x164 mm); 4 x M20, 4 x
M16, 14 x M12 cable grip

**Item No.: 850-836**

IP65 enclosure; Polyester (RAL 7032);
WxHxD (324x100x164 mm); 4 x M20, 8 x
M16, 17 x M12 cable grip

**Item No.: 850-814/002-000**

IP65 enclosure; Sheet steel (RAL 7035);
WxHxD (200x120x200 mm); without flan-
ge plate

**Item No.: 850-815/002-000**

IP65 enclosure; Sheet steel (RAL 7035);
WxHxD (300x120x200 mm); without flan-
ge plate

**Item No.: 850-816/002-000**

IP65 enclosure; Sheet steel (RAL 7035);
WxHxD (400x120x200 mm); without flan-
ge plate

**Item No.: 850-817/002-000**

IP65 enclosure; Sheet steel (RAL 7035);
WxHxD (600x120x200 mm); without flan-
ge plate