

# Data Sheet | Item Number: 765-1105/100-000

8-channel digital input/output; Profinet; DC 24 V / 2.0 A; 8xM8 connection; SlimLine

<https://www.wago.com/765-1105/100-000>

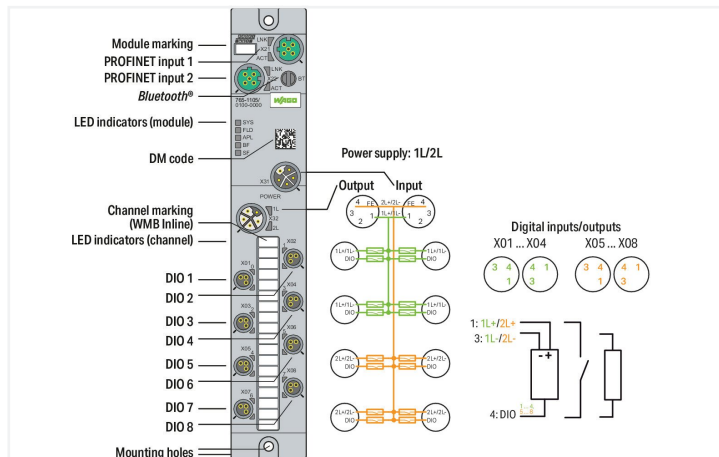

Einsatzbereich:  
Dezentrale Verarbeitung von Digitalsignalen.

Das Gerät dient zur Erfassung und Ansteuerung digitaler Feldgeräte, z. B. von Sensoren und Aktoren, die von einer übergeordneten Steuerung empfangen bzw. angesteuert werden.

Das Gerät bietet 8 digitale Ein-/Ausgänge.

## Technical data

### Fieldbus

Communication	PROFINET PROFINET IO device; 2-port switch, LLDP, MRP, SNMP
Connection technology: communication/fieldbus	2 x D-coded M12; 4-pole
Interface standard	10BASE-T/100BASE-TX; potential-free
Autonegotiation; autocrossover	Yes
PROFINET IO features	PROFINET IO device; 2-port switch, LLDP, MRP, SNMP

### Device functions

Parameter	Input filter Output current Temperature
Diagnostics	Undervoltage; overcurrent; overload; overtemperature
Device functions	Bluetooth® OPC UA server
Visualization	Android/iOS app Web server

### Digital inputs/outputs

Number of digital inputs	8
Number of digital outputs	8
Connection technology: inputs/outputs	8 x M8; 3-pole
Signal type (voltage)	24 VDC
Input characteristic	high-side switching Type 3, per IEC 61131-2
Input filter	0.2 ... 20 ms
Output current (per channel)	2 A (typ.) for DO
Supply current per port	1L/2L: 4 A (max.)

### Supply (module)

Connection technology: supply	2 x L-coded M12; 5-pole
Supply voltage	24 VDC (18 ... 31.2 V); 1L/2L
Current consumption (max.)	16000 mA
Current consumption (note)	per supply line; overload- and short-circuit-protected
Reverse voltage protection	Yes

### Physical data

Width	35 mm / 1.378 inches
Height	30 mm / 1.181 inches
Depth	210 mm / 8.268 inches

### Mechanical data

Weight	390 g
Conformity marking	CE

### Environmental requirements

Ambient temperature (operation)	-25 ... +70 °C
Ambient temperature (storage)	-40 ... +80 °C
Protection type	IP67
Protection class	III per EN 61140, IEC 61140, VDE 0140-1
Operating altitude	0 ... 2000 m / 0 ... 6562 ft
Pollution degree	3 (EN 60664-1)
Overvoltage category	II (EN 60664-1)
Relative humidity (without condensation)	95 %
Vibration resistance	5g per IEC 60068-2-6
Shock resistance	Short-term: 50g/11 ms/half-sine per IEC 60068-2-27; Long-term: 30g/6 ms/half-sine per IEC 60068-2-29
EMC immunity to interference	per EN 61000-6-2
EMC emission of interference	per EN 61000-6-4

### Commercial data

ETIM 8.0	EC001599
ETIM 7.0	EC001599
PU (SPU)	1 pcs
Packaging type	Box
Country of origin	DE
GTIN	4055143949705
Customs tariff number	85371098990

### Environmental Product Compliance

CAS-No.	7439-92-1
REACH Candidate List Substance	Lead
RoHS Compliance Status	Compliant,With Exemption
RoHS Exemption	6(c) 7(a) 7(c)-I
SCIP notification number (Austria)	fc81964e-bcd2-4fb0-8c80-389abc734aa6
SCIP notification number (Belgium)	292d81f3-f672-4e32-b971-8165fd63de3e
SCIP notification number (Bulgaria)	d0229fe5-1a4c-4edf-8d62-3e861bb4359b
SCIP notification number (Czech Republic)	56dca3ae-ac9c-492e-a5cc-0de06613f914
SCIP notification number (Denmark)	997246b1-459e-4ec7-bf6a-56081cfe27a4
SCIP notification number (Finland)	e707f48d-4e06-401b-8812-4990f23a331f
SCIP notification number (France)	98d57770-6820-4582-8901-0f6f20ca5c39
SCIP notification number (Germany)	854e0d9b-ee55-4440-8f99-bc29f43c91a9
SCIP notification number (Hungary)	fb650acb-6862-4853-a7c6-1f454e1297d9
SCIP notification number (Italy)	dd9ff4cc-127c-4353-a564-3364f513f146
SCIP notification number (Netherlands)	660457c3-5f7f-457d-bd92-22d1db1f2b10
SCIP notification number (Poland)	81687b15-dfd5-40ff-961d-8676755575e5
SCIP notification number (Romania)	3d5d0282-ef7e-4f25-86e3-4465c4b592ae
SCIP notification number (Sweden)	fbca236e-706d-40c8-9328-d64b37ca9bf5

## Approvals / Certificates

### General approvals



Approval	Standard	Certificate Name
KC National Radio Research Agency	Article 58-2, Clause 3	KC R-R-W43-FB765

## Downloads

### Environmental Product Compliance

#### Compliance Search

Environmental Product  
Compliance  
765-1105/100-000



## Documentation

### Manual

Product Manual 8- Channel Digital Input/ Output; Profinet	V 2.2.0 19.07.2022	pdf 7426.42 KB	
---	-----------------------	-------------------	---

### System Description

WAGO I/O System Field; General Product Infor- mation	pdf 1009.23 KB	
--	-------------------	---

### Instruction Leaflet

I/O System Field packa- ge insert	15.12.2021	pdf 1083.98 KB	
--------------------------------------	------------	-------------------	---

## CAD/CAE-Data

### CAD data

2D/3D Models 765-1105/100-000	
----------------------------------	---

### CAE data

EPLAN Data Portal 765-1105/100-000	
ZUKEN Portal 765-1105/100-000	



## Runtime Software

### Firmware

0765-x1xx, Profinet IO- Field	V 04 02.02.2023	zip 1595.41 KB	
----------------------------------	--------------------	-------------------	---

## Libraries

### Device Description File

750-916; GSD files of version 2.x for PROFINET/ series 750/753, 765, 767 and 852	3.0 15.01.2023	zip 2582.40 KB	
Gerätebeschreibungsdateien 765-41xx, 765-11xx, PROFINET	V1_1_0_22	zip 27.85 KB	

## 1 Compatible Products

### 1.1 Required Accessories

#### 1.1.1 Cover

##### 1.1.1.1 Cover



[Item No.: 756-8103](#)

M12 protective cap; for unused plugs

[Item No.: 756-8102](#)

M12 protective cap; for unused sockets

[Item No.: 756-8101](#)

M8 protective cap; for unused sockets

#### 1.1.2 Marking

##### 1.1.2.1 Marker



[Item No.: 2009-115](#)

WMB-Inline; for Smart Printer; 1500 pieces on roll; stretchable 5 - 5.2 mm; plain; snap-on type; white

##### 1.1.2.2 Marking strip



[Item No.: 2009-110](#)

Marking strips; for Smart Printer; on reel; not stretchable; plain; snap-on type; white

#### 1.1.3 Tool

##### 1.1.3.1 Assembly tool



[Item No.: 206-701](#)

Torque wrench M8 and M12; Assembly kit

1.2 Optional Accessories

1.2.1 Cables and connectors

1.2.1.1 Adapter



**Item No.: 756-9503/040-000**  
Accessories; 4-pole

**Item No.: 756-9504/040-000**  
Accessories; 4-pole

1.2.1.2 Configurable connector



**Item No.: 756-9105/030-000**  
Fitted pluggable connector; 3-pole; M8 plug, right angle; IDC technology

**Item No.: 756-9102/030-000**  
Fitted pluggable connector; 3-pole; M8 plug, straight; IDC technology

**Item No.: 756-9701/050-000**  
Fitted pluggable connector; 5-pole, shielded; M12 plug, straight; IDC technology

**Item No.: 756-9711/050-000**  
Fitted pluggable connector; 5-pole, shielded; M12 socket, straight; IDC technology

1.2.1.3 Configurable shielded connector



**Item No.: 756-9501/040-000**  
Accessories; M12 plug, right angle; 4-pole

**Item No.: 756-9501/060-000**  
Fitted pluggable connector; 4-pole, shielded; M12 plug, straight, D-coded; Spring

1.2.1.4 ETHERNET/PROFINET cable



**Item No.: 756-1202/060-100**  
ETHERNET cable; M12D plug; angled; 4-pole; Length: 10 m

**Item No.: 756-1202/060-020**  
ETHERNET cable; M12D plug; angled; 4-pole; Length: 2 m

**Item No.: 756-1202/060-200**  
ETHERNET cable; M12D plug; angled; 4-pole; Length: 20 m

**Item No.: 756-1202/060-050**  
ETHERNET cable; M12D plug; angled; 4-pole; Length: 5 m



**Item No.: 756-1204/060-010**  
ETHERNET cable; M12D plug; angled; M12D plug; angled; 4-pole; Length: 1 m

**Item No.: 756-1204/060-100**  
ETHERNET cable; M12D plug; angled; M12D plug; angled; 4-pole; Length: 10 m

**Item No.: 756-1204/060-020**  
ETHERNET cable; M12D plug; angled; M12D plug; angled; 4-pole; Length: 2 m

**Item No.: 756-1204/060-200**  
ETHERNET cable; M12D plug; angled; M12D plug; angled; 4-pole; Length: 20 m



**Item No.: 756-1204/060-030**  
ETHERNET cable; M12D plug; angled; M12D plug; angled; 4-pole; Length: 3 m

**Item No.: 756-1204/060-050**  
ETHERNET cable; M12D plug; angled; M12D plug; angled; 4-pole; Length: 5 m

**Item No.: 756-1201/060-100**  
ETHERNET cable; M12D plug; straight; 4-pole; Length: 10 m

**Item No.: 756-1201/060-020**  
ETHERNET cable; M12D plug; straight; 4-pole; Length: 2 m



**Item No.: 756-1201/060-200**  
ETHERNET cable; M12D plug; straight; 4-pole; Length: 20 m

**Item No.: 756-1201/060-050**  
ETHERNET cable; M12D plug; straight; 4-pole; Length: 5 m

**Item No.: 756-1203/060-100**  
ETHERNET cable; M12D plug; straight; M12D plug; straight; 4-pole; Length: 10 m















**Item No.: 756-1203/060-020**  
ETHERNET cable; M12D plug; straight; M12D plug; straight; 4-pole; Length: 2 m







**Item No.: 756-1203/060-200**  
ETHERNET cable; M12D plug; straight; M12D plug; straight; 4-pole; Length: 20 m

**Item No.: 756-1203/060-050**  
ETHERNET cable; M12D plug; straight; M12D plug; straight; 4-pole; Length: 5 m

1.2.1.5 Power cable

 <b>Item No.: 756-3504/050-100</b> Power cable; M12L plug; angled; 5-pole; Length: 10 m	 <b>Item No.: 756-3504/050-150</b> Power cable; M12L plug; angled; 5-pole; Length: 15 m	 <b>Item No.: 756-3504/050-020</b> Power cable; M12L plug; angled; 5-pole; Length: 2 m	 <b>Item No.: 756-3504/050-050</b> Power cable; M12L plug; angled; 5-pole; Length: 5 m
 <b>Item No.: 756-3504/050-075</b> Power cable; M12L plug; angled; 5-pole; Length: 7.5 m	 <b>Item No.: 756-3503/050-100</b> Power cable; M12L plug; straight; 5-pole; Length: 10 m	 <b>Item No.: 756-3503/050-150</b> Power cable; M12L plug; straight; 5-pole; Length: 15 m	 <b>Item No.: 756-3503/050-020</b> Power cable; M12L plug; straight; 5-pole; Length: 2 m
 <b>Item No.: 756-3503/050-050</b> Power cable; M12L plug; straight; 5-pole; Length: 5 m	 <b>Item No.: 756-3503/050-075</b> Power cable; M12L plug; straight; 5-pole; Length: 7.5 m	 <b>Item No.: 756-3502/050-100</b> Power cable; M12L socket; angled; 5-pole; Length: 10 m	 <b>Item No.: 756-3502/050-150</b> Power cable; M12L socket; angled; 5-pole; Length: 15 m
 <b>Item No.: 756-3502/050-020</b> Power cable; M12L socket; angled; 5-pole; Length: 2 m	 <b>Item No.: 756-3502/050-050</b> Power cable; M12L socket; angled; 5-pole; Length: 5 m	 <b>Item No.: 756-3502/050-075</b> Power cable; M12L socket; angled; 5-pole; Length: 7.5 m	 <b>Item No.: 756-3506/050-003</b> Power cable; M12L socket; angled; M12L plug; angled; 5-pole; Length: 0.3 m
 <b>Item No.: 756-3506/050-005</b> Power cable; M12L socket; angled; M12L plug; angled; 5-pole; Length: 0.5 m	 <b>Item No.: 756-3506/050-010</b> Power cable; M12L socket; angled; M12L plug; angled; 5-pole; Length: 1 m	 <b>Item No.: 756-3506/050-100</b> Power cable; M12L socket; angled; M12L plug; angled; 5-pole; Length: 10 m	 <b>Item No.: 756-3506/050-150</b> Power cable; M12L socket; angled; M12L plug; angled; 5-pole; Length: 15 m
 <b>Item No.: 756-3506/050-020</b> Power cable; M12L socket; angled; M12L plug; angled; 5-pole; Length: 2 m	 <b>Item No.: 756-3506/050-050</b> Power cable; M12L socket; angled; M12L plug; angled; 5-pole; Length: 5 m	 <b>Item No.: 756-3506/050-075</b> Power cable; M12L socket; angled; M12L plug; angled; 5-pole; Length: 7.5 m	 <b>Item No.: 756-3501/050-100</b> Power cable; M12L socket; straight; 5-pole; Length: 10 m
 <b>Item No.: 756-3501/050-150</b> Power cable; M12L socket; straight; 5-pole; Length: 15 m	 <b>Item No.: 756-3501/050-020</b> Power cable; M12L socket; straight; 5-pole; Length: 2 m	 <b>Item No.: 756-3501/050-050</b> Power cable; M12L socket; straight; 5-pole; Length: 5 m	 <b>Item No.: 756-3501/050-075</b> Power cable; M12L socket; straight; 5-pole; Length: 7.5 m
 <b>Item No.: 756-3505/050-003</b> Power cable; M12L socket; straight; M12L plug; straight; 5-pole; Length: 0.3 m	 <b>Item No.: 756-3505/050-005</b> Power cable; M12L socket; straight; M12L plug; straight; 5-pole; Length: 0.5 m	 <b>Item No.: 756-3505/050-010</b> Power cable; M12L socket; straight; M12L plug; straight; 5-pole; Length: 1 m	 <b>Item No.: 756-3505/050-100</b> Power cable; M12L socket; straight; M12L plug; straight; 5-pole; Length: 10 m
 <b>Item No.: 756-3505/050-150</b> Power cable; M12L socket; straight; M12L plug; straight; 5-pole; Length: 15 m	 <b>Item No.: 756-3505/050-020</b> Power cable; M12L socket; straight; M12L plug; straight; 5-pole; Length: 2 m	 <b>Item No.: 756-3505/050-050</b> Power cable; M12L socket; straight; M12L plug; straight; 5-pole; Length: 5 m	 <b>Item No.: 756-3505/050-075</b> Power cable; M12L socket; straight; M12L plug; straight; 5-pole; Length: 7.5 m

1.2.1.6 Sensor/actuator cable

 <b>Item No.: 756-5504/030-010</b> Sensor/Actuator cable; M12A socket; angled; M8 plug; angled; 3-pole; Length: 1 m	 <b>Item No.: 756-5504/030-020</b> Sensor/Actuator cable; M12A socket; angled; M8 plug; angled; 3-pole; Length: 2 m	 <b>Item No.: 756-5503/030-010</b> Sensor/Actuator cable; M12A socket; angled; M8 plug; straight; 3-pole; Length: 1 m	 <b>Item No.: 756-5503/030-020</b> Sensor/Actuator cable; M12A socket; angled; M8 plug; straight; 3-pole; Length: 2 m
 <b>Item No.: 756-5502/030-010</b> Sensor/Actuator cable; M12A socket; straight; M8 plug; angled; 3-pole; Length: 1 m	 <b>Item No.: 756-5502/030-020</b> Sensor/Actuator cable; M12A socket; straight; M8 plug; angled; 3-pole; Length: 2 m	 <b>Item No.: 756-5501/030-010</b> Sensor/Actuator cable; M12A socket; straight; M8 plug; straight; 3-pole; Length: 1 m	 <b>Item No.: 756-5501/030-020</b> Sensor/Actuator cable; M12A socket; straight; M8 plug; straight; 3-pole; Length: 2 m
 <b>Item No.: 756-5112/030-015</b> Sensor/Actuator cable; M8 plug; angled; 3-pole; Length: 1.5 m	 <b>Item No.: 756-5112/030-100</b> Sensor/Actuator cable; M8 plug; angled; 3-pole; Length: 10 m	 <b>Item No.: 756-5112/030-050</b> Sensor/Actuator cable; M8 plug; angled; 3-pole; Length: 5 m	 <b>Item No.: 756-5111/030-015</b> Sensor/Actuator cable; M8 plug; straight; 3-pole; Length: 1.5 m

1.2.1.6 Sensor/actuator cable



**Item No.: 756-5111/030-100**  
 Sensor/Actuator cable; M8 plug; straight;  
 3-pole; Length: 10 m

**Item No.: 756-5111/030-050**  
 Sensor/Actuator cable; M8 plug; straight;  
 3-pole; Length: 5 m

**Item No.: 756-5204/030-010**  
 Sensor/Actuator cable; M8 socket;  
 angled; M8 plug; angled; 3-pole; Length: 1  
 m

**Item No.: 756-5204/030-020**  
 Sensor/Actuator cable; M8 socket; angled;  
 M8 plug; angled; 3-pole; Length: 2 m



**Item No.: 756-5203/030-010**  
 Sensor/Actuator cable; M8 socket; angled;  
 M8 plug; straight; 3-pole; Length: 1 m

**Item No.: 756-5203/030-020**  
 Sensor/Actuator cable; M8 socket;  
 angled; M8 plug; straight; 3-pole; Length:  
 2 m

**Item No.: 756-5202/030-010**  
 Sensor/Actuator cable; M8 socket;  
 straight; M8 plug; angled; 3-pole; Length:  
 1 m

**Item No.: 756-5202/030-020**  
 Sensor/Actuator cable; M8 socket;  
 straight; M8 plug; angled; 3-pole; Length:  
 2 m



**Item No.: 756-5201/030-010**  
 Sensor/Actuator cable; M8 socket;  
 straight; M8 plug; straight; 3-pole; Length:  
 1 m

**Item No.: 756-5201/030-020**  
 Sensor/Actuator cable; M8 socket;  
 straight; M8 plug; straight; 3-pole; Length:  
 2 m