

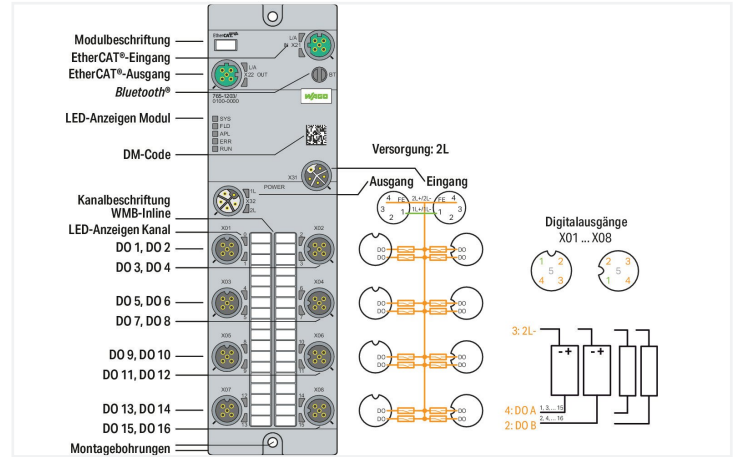

Similar to illustration



Einsatzbereich:
Dezentrale Verarbeitung von Digitalsignalen.

Das Gerät dient zur Erfassung und Ansteuerung digitaler Feldgeräte, z. B. von Sensoren und Aktoren, die von einer übergeordneten Steuerung empfangen bzw. angesteuert werden.

Das Gerät bietet 16 digitale Ausgänge.

Technical data

Fieldbus		Device functions	
Communication	EtherCAT® AoE, EoE, FoE	Parameter	Output current Temperature
Connection technology: communication/ fieldbus	2 x D-coded M12; 4-pole	Diagnostics	Undervoltage; overcurrent; overload; overtemperature
Interface standard	10BASE-T/100BASE-TX; potential-free	Device functions	Bluetooth® OPC UA server
Autonegotiation; autocrossover	Yes	Visualization	Android/iOS app Web server
Digital inputs/outputs		Supply (module)	
Number of digital outputs	16	Connection technology: supply	2 x L-coded M12; 5-pole
Connection technology: inputs/outputs	8 x A-coded M12; 5-pole	Supply voltage	24 VDC (18 ... 31.2 V); 1L/2L
Signal type (voltage)	24 VDC	Current consumption (max.)	16000 mA
Output current (per channel)	2 A (typ.) for DO	Current consumption (note)	per supply line; overload- and short-circuit-protected
Supply current per port	1L/2L: 4 A (max.)	Reverse voltage protection	Yes

Physical data

Width	60 mm / 2.362 inches
Height	30 mm / 1.181 inches
Depth	210 mm / 8.268 inches

Mechanical data

Weight	610 g
Conformity marking	CE

Environmental requirements

Ambient temperature (operation)	-25 ... +70 °C
Ambient temperature (storage)	-40 ... +80 °C
Protection type	IP67
Protection class	III per EN 61140, IEC 61140, VDE 0140-1
Operating altitude	0 ... 2000 m / 0 ... 6562 ft
Pollution degree	3 (EN 60664-1)
Overvoltage category	II (EN 60664-1)
Relative humidity (without condensation)	95 %
Vibration resistance	5g per IEC 60068-2-6
Shock resistance	Short-term: 50g/11 ms/half-sine per IEC 60068-2-27; Long-term: 30g/6 ms/half-sine per IEC 60068-2-29
EMC immunity to interference	per EN 61000-6-2
EMC emission of interference	per EN 61000-6-4

Commercial data

ETIM 8.0	EC001599
ETIM 7.0	EC001599
PU (SPU)	1 pcs
Country of origin	DE
GTIN	4066966063035
Customs tariff number	85371098990

Environmental Product Compliance

RoHS Compliance Status	Compliant, No Exemption
------------------------	-------------------------

Approvals / Certificates

General approvals



Approval	Standard	Certificate Name
KC National Radio Research Agency	Article 58-2, Clause 3	KC R-R-W43-FB765

Downloads

Environmental Product Compliance

Compliance Search

Environmental Product
Compliance
765-1203/100-000



Documentation

Manual

Product Manual 16-
Channel Digital Output;
EtherCAT; 24 VDC / 2.0
A;

V 2.0.0
19.07.2022

pdf
7618.55 KB



System Description

WAGO I/O System Field;
General Product Infor-
mation

pdf
1009.23 KB



Application Notes

Application Note e!COCKPIT

e!COCKPIT Application
Note EtherCAT IO-Field
(a2022003)

1.0.0
23.03.2023

pptx
2143.63 KB



CAD/CAE-Data

CAD data

2D/3D Models
765-1203/100-000



CAE data

EPLAN Data Portal
765-1203/100-000



Runtime Software

Firmware

0765-x2xx, EtherCat
IO-Field

V 04
02.02.2023

zip
1582.68 KB



Libraries

Device Description File

Gerätebeschreibungs-
dateien 765-42xx,
765-12xx, EtherCAT

V1_1_0_22

zip
75.78 KB



1 Compatible Products

1.1 Required Accessories

1.1.1 Cover

1.1.1.1 Cover



[Item No.: 756-8103](#)

M12 protective cap; for unused plugs

[Item No.: 756-8102](#)

M12 protective cap; for unused sockets

1.1.2 Marking

1.1.2.1 Marker



[Item No.: 2009-115](#)

WMB-Inline; for Smart Printer; 1500 pieces on roll; stretchable 5 - 5.2 mm; plain; snap-on type; white

1.1.2.2 Marking strip



[Item No.: 2009-110](#)

Marking strips; for Smart Printer; on reel; not stretchable; plain; snap-on type; white

1.1.3 Tool

1.1.3.1 Assembly tool



[Item No.: 206-701](#)

Torque wrench M8 and M12; Assembly kit

1.2 Optional Accessories

1.2.1 Cables and connectors

1.2.1.1 Adapter



[Item No.: 756-9503/040-000](#)

Accessories; 4-pole

[Item No.: 756-9504/040-000](#)

Accessories; 4-pole

1.2.1.2 Configurable connector



Item No.: 756-9205/040-000
Fitted pluggable connector; 4-pole; M12 plug, right angle; Spring



Item No.: 756-9202/040-000
Fitted pluggable connector; 4-pole; M12 plug, straight, A-coded; Spring



Item No.: 756-9701/050-000
Fitted pluggable connector; 5-pole, shielded; M12 plug, straight; IDC technology



Item No.: 756-9711/050-000
Fitted pluggable connector; 5-pole, shielded; M12 socket, straight; IDC technology

1.2.1.3 Configurable shielded connector



Item No.: 756-9501/040-000
Accessories; M12 plug, right angle; 4-pole



Item No.: 756-9501/060-000
Fitted pluggable connector; 4-pole, shielded; M12 plug, straight, D-coded; Spring

1.2.1.4 Distribution connector



Item No.: 756-9301/040-000
Accessories; 4-pole



Item No.: 756-9301/050-000
Accessories; 5-pole



Item No.: 756-5517/040-010
Sensor/Actuator cable; 2xM12 socket; angled; M12A plug; straight; 4-pole; Length: 1 m



Item No.: 756-5517/040-020
Sensor/Actuator cable; 2xM12 socket; angled; M12A plug; straight; 4-pole; Length: 2 m



Item No.: 756-5516/040-010
Sensor/Actuator cable; 2xM12 socket; straight; M12A plug; straight; 4-pole; Length: 1 m



Item No.: 756-5516/040-020
Sensor/Actuator cable; 2xM12 socket; straight; M12A plug; straight; 4-pole; Length: 2 m



Item No.: 756-5514/040-010
Sensor/Actuator cable; 2xM12 socket; angled; M12A plug; straight; 4-pole; Length: 1 m



Item No.: 756-5514/040-020
Sensor/Actuator cable; 2xM8 socket; angled; M12A plug; straight; 4-pole; Length: 2 m



Item No.: 756-5513/040-010
Sensor/Actuator cable; 2xM8 socket; straight; M12A plug; straight; 4-pole; Length: 1 m



Item No.: 756-5513/040-020
Sensor/Actuator cable; 2xM8 socket; straight; M12A plug; straight; 4-pole; Length: 2 m

1.2.1.5 ETHERNET/PROFINET cable



Item No.: 756-1202/060-100
ETHERNET cable; M12D plug; angled; 4-pole; Length: 10 m



Item No.: 756-1202/060-020
ETHERNET cable; M12D plug; angled; 4-pole; Length: 2 m



Item No.: 756-1202/060-200
ETHERNET cable; M12D plug; angled; 4-pole; Length: 20 m



Item No.: 756-1202/060-050
ETHERNET cable; M12D plug; angled; 4-pole; Length: 5 m



Item No.: 756-1204/060-010
ETHERNET cable; M12D plug; angled; M12D plug; angled; 4-pole; Length: 1 m



Item No.: 756-1204/060-100
ETHERNET cable; M12D plug; angled; M12D plug; angled; 4-pole; Length: 10 m



Item No.: 756-1204/060-020
ETHERNET cable; M12D plug; angled; M12D plug; angled; 4-pole; Length: 2 m



Item No.: 756-1204/060-200
ETHERNET cable; M12D plug; angled; M12D plug; angled; 4-pole; Length: 20 m



Item No.: 756-1204/060-030
ETHERNET cable; M12D plug; angled; M12D plug; angled; 4-pole; Length: 3 m



Item No.: 756-1204/060-050
ETHERNET cable; M12D plug; angled; M12D plug; angled; 4-pole; Length: 5 m



Item No.: 756-1201/060-100
ETHERNET cable; M12D plug; straight; 4-pole; Length: 10 m



Item No.: 756-1201/060-020
ETHERNET cable; M12D plug; straight; 4-pole; Length: 2 m



Item No.: 756-1201/060-200
ETHERNET cable; M12D plug; straight; 4-pole; Length: 20 m



Item No.: 756-1201/060-050
ETHERNET cable; M12D plug; straight; 4-pole; Length: 5 m



Item No.: 756-1203/060-100
ETHERNET cable; M12D plug; straight; M12D plug; straight; 4-pole; Length: 10 m



Item No.: 756-1203/060-020
ETHERNET cable; M12D plug; straight; M12D plug; straight; 4-pole; Length: 2 m



















Item No.: 756-1203/060-200
ETHERNET cable; M12D plug; straight; M12D plug; straight; 4-pole; Length: 20 m















Item No.: 756-1203/060-050
ETHERNET cable; M12D plug; straight; M12D plug; straight; 4-pole; Length: 5 m

1.2.1.6 Power cable

 Item No.: 756-3504/050-100 Power cable; M12L plug; angled; 5-pole; Length: 10 m	 Item No.: 756-3504/050-150 Power cable; M12L plug; angled; 5-pole; Length: 15 m	 Item No.: 756-3504/050-020 Power cable; M12L plug; angled; 5-pole; Length: 2 m	 Item No.: 756-3504/050-050 Power cable; M12L plug; angled; 5-pole; Length: 5 m
 Item No.: 756-3504/050-075 Power cable; M12L plug; angled; 5-pole; Length: 7.5 m	 Item No.: 756-3503/050-100 Power cable; M12L plug; straight; 5-pole; Length: 10 m	 Item No.: 756-3503/050-150 Power cable; M12L plug; straight; 5-pole; Length: 15 m	 Item No.: 756-3503/050-020 Power cable; M12L plug; straight; 5-pole; Length: 2 m
 Item No.: 756-3503/050-050 Power cable; M12L plug; straight; 5-pole; Length: 5 m	 Item No.: 756-3503/050-075 Power cable; M12L plug; straight; 5-pole; Length: 7.5 m	 Item No.: 756-3502/050-100 Power cable; M12L socket; angled; 5-pole; Length: 10 m	 Item No.: 756-3502/050-150 Power cable; M12L socket; angled; 5-pole; Length: 15 m
 Item No.: 756-3502/050-020 Power cable; M12L socket; angled; 5-pole; Length: 2 m	 Item No.: 756-3502/050-050 Power cable; M12L socket; angled; 5-pole; Length: 5 m	 Item No.: 756-3502/050-075 Power cable; M12L socket; angled; 5-pole; Length: 7.5 m	 Item No.: 756-3506/050-003 Power cable; M12L socket; angled; M12L plug; angled; 5-pole; Length: 0.3 m
 Item No.: 756-3506/050-005 Power cable; M12L socket; angled; M12L plug; angled; 5-pole; Length: 0.5 m	 Item No.: 756-3506/050-010 Power cable; M12L socket; angled; M12L plug; angled; 5-pole; Length: 1 m	 Item No.: 756-3506/050-100 Power cable; M12L socket; angled; M12L plug; angled; 5-pole; Length: 10 m	 Item No.: 756-3506/050-150 Power cable; M12L socket; angled; M12L plug; angled; 5-pole; Length: 15 m
 Item No.: 756-3506/050-020 Power cable; M12L socket; angled; M12L plug; angled; 5-pole; Length: 2 m	 Item No.: 756-3506/050-050 Power cable; M12L socket; angled; M12L plug; angled; 5-pole; Length: 5 m	 Item No.: 756-3506/050-075 Power cable; M12L socket; angled; M12L plug; angled; 5-pole; Length: 7.5 m	 Item No.: 756-3501/050-100 Power cable; M12L socket; straight; 5-pole; Length: 10 m
 Item No.: 756-3501/050-150 Power cable; M12L socket; straight; 5-pole; Length: 15 m	 Item No.: 756-3501/050-020 Power cable; M12L socket; straight; 5-pole; Length: 2 m	 Item No.: 756-3501/050-050 Power cable; M12L socket; straight; 5-pole; Length: 5 m	 Item No.: 756-3501/050-075 Power cable; M12L socket; straight; 5-pole; Length: 7.5 m
 Item No.: 756-3505/050-003 Power cable; M12L socket; straight; M12L plug; straight; 5-pole; Length: 0.3 m	 Item No.: 756-3505/050-005 Power cable; M12L socket; straight; M12L plug; straight; 5-pole; Length: 0.5 m	 Item No.: 756-3505/050-010 Power cable; M12L socket; straight; M12L plug; straight; 5-pole; Length: 1 m	 Item No.: 756-3505/050-100 Power cable; M12L socket; straight; M12L plug; straight; 5-pole; Length: 10 m
 Item No.: 756-3505/050-150 Power cable; M12L socket; straight; M12L plug; straight; 5-pole; Length: 15 m	 Item No.: 756-3505/050-020 Power cable; M12L socket; straight; M12L plug; straight; 5-pole; Length: 2 m	 Item No.: 756-3505/050-050 Power cable; M12L socket; straight; M12L plug; straight; 5-pole; Length: 5 m	 Item No.: 756-3505/050-075 Power cable; M12L socket; straight; M12L plug; straight; 5-pole; Length: 7.5 m

1.2.1.7 Sensor/actuator cable

 Item No.: 756-5312/040-015 Sensor/Actuator cable; M12A plug; angled; 4-pole; Length: 1.5 m	 Item No.: 756-5312/040-100 Sensor/Actuator cable; M12A plug; angled; 4-pole; Length: 10 m	 Item No.: 756-5312/040-050 Sensor/Actuator cable; M12A plug; angled; 4-pole; Length: 5 m	 Item No.: 756-5311/040-015 Sensor/Actuator cable; M12A plug; straight; 4-pole; Length: 1.5 m
 Item No.: 756-5311/040-100 Sensor/Actuator cable; M12A plug; straight; 4-pole; Length: 10 m	 Item No.: 756-5311/040-050 Sensor/Actuator cable; M12A plug; straight; 4-pole; Length: 5 m	 Item No.: 756-5404/040-010 Sensor/Actuator cable; M12A socket; angled; M12A plug; angled; 4-pole; Length: 1 m	 Item No.: 756-5404/040-020 Sensor/Actuator cable; M12A socket; angled; M12A plug; angled; 4-pole; Length: 2 m
 Item No.: 756-5403/040-010 Sensor/Actuator cable; M12A socket; angled; M12A plug; straight; 4-pole; Length: 1 m	 Item No.: 756-5403/040-020 Sensor/Actuator cable; M12A socket; angled; M12A plug; straight; 4-pole; Length: 2 m	 Item No.: 756-5402/040-010 Sensor/Actuator cable; M12A socket; straight; M12A plug; angled; 4-pole; Length: 1 m	 Item No.: 756-5402/040-020 Sensor/Actuator cable; M12A socket; straight; M12A plug; angled; 4-pole; Length: 2 m

1.2.1.7 Sensor/actuator cable



Item No.: 756-5401/040-010
 Sensor/Actuator cable; M12A socket; straight; M12A plug; straight; 4-pole; Length: 1 m



Item No.: 756-5401/040-020
 Sensor/Actuator cable; M12A socket; straight; M12A plug; straight; 4-pole; Length: 2 m



Item No.: 756-5510/040-010
 Sensor/Actuator cable; M8 socket; angled; M12A plug; angled; 4-pole; Length: 1 m



Item No.: 756-5510/040-020
 Sensor/Actuator cable; M8 socket; angled; M12A plug; angled; 4-pole; Length: 2 m



Item No.: 756-5509/040-010
 Sensor/Actuator cable; M8 socket; angled; M12A plug; straight; 4-pole; Length: 1 m



Item No.: 756-5509/040-020
 Sensor/Actuator cable; M8 socket; angled; M12A plug; straight; 4-pole; Length: 2 m



Item No.: 756-5508/040-010
 Sensor/Actuator cable; M8 socket; straight; M12A plug; angled; 4-pole; Length: 1 m



Item No.: 756-5508/040-020
 Sensor/Actuator cable; M8 socket; straight; M12A plug; angled; 4-pole; Length: 2 m



Item No.: 756-5507/040-010
 Sensor/Actuator cable; M8 socket; straight; M12A plug; straight; 4-pole; Length: 1 m



Item No.: 756-5507/040-020
 Sensor/Actuator cable; M8 socket; straight; M12A plug; straight; 4-pole; Length: 2 m