

Data Sheet | Item Number: 232-102/026-000

1-conductor female connector, angled; CAGE CLAMP®; 2.5 mm²; Pin spacing 5 mm;
2-pole; 2,50 mm²; gray

<https://www.wago.com/232-102/026-000>



Color: ■ gray

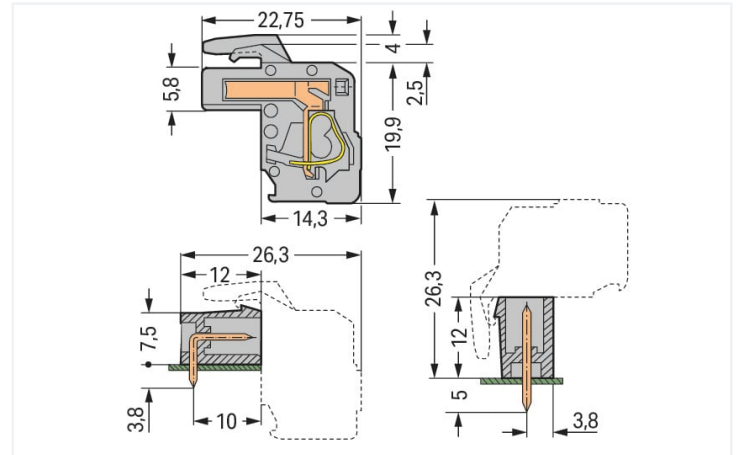

Dimensions in mm

$L = (\text{pole no.} \times \text{pin spacing}) + 1.5 \text{ mm} + 0.9 \text{ mm}$

2- to 3-pole female connectors – one latch only

Derating Curve

1-conductor female connector (231-102/026-000) with
THT male header (231-432/001-000)
Pin spacing: 5 mm / Conductor cross-section: 2.5 mm² *f-st*
Based on: EN 60512-5-2 / Reduction factor: 0.8

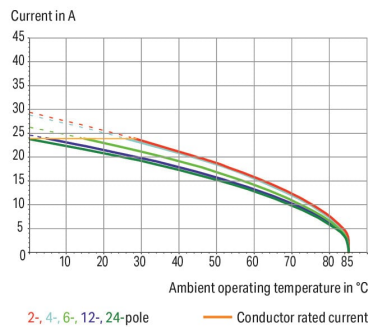

- Universal connection for all conductor types
- Easy cable pre-assembly and on-unit wiring via vertical and horizontal CAGE CLAMP® actuation
- Integrated test ports
- With coding fingers

Notes

Safety information

The MCS – MULTI CONNECTION SYSTEM includes connectors without breaking capacity in accordance with DIN EN 61984. When used as intended, these connectors must not be connected/disconnected when live or under load. When used as intended, these connectors must not be connected/disconnected when live or under load. The circuit design should ensure header pins, which can be touched, are not live when unmated.

Variants:

Gold-plated or partially gold-plated contact surfaces

Other versions (or variants) can be requested from WAGO Sales or configured at <https://configurator.wago.com/>.

Electrical data

Ratings per	IEC/EN 60664-1		
Overvoltage category	III	III	II
Pollution degree	3	2	2
Nominal voltage	320 V	320 V	630 V
Rated surge voltage	4 kV	4 kV	4 kV
Rated current	14 A	14 A	14 A

Approvals per	UL 1059		
Use group	B	C	D
Rated voltage	300 V	-	300 V
Rated current	15 A	-	10 A

Approvals per	UL 1977
Rated voltage	600 V
Rated current	15 A

Approvals per	CSA		
Use group	B	C	D
Rated voltage	300 V	-	300 V
Rated current	15 A	-	10 A

Connection data

Connection points	2
Total number of potentials	2
Number of connection types	1
Number of levels	1

Connection 1	
Connection technology	CAGE CLAMP®
Actuation type	Operating tool
Actuation direction 1	Operation parallel to conductor entry
Actuation direction 2	Operation perpendicular to conductor entry
Solid conductor	0.08 ... 2.5 mm ² / 28 ... 12 AWG
Fine-stranded conductor	0.08 ... 2.5 mm ² / 28 ... 12 AWG
Fine-stranded conductor; with insulated ferrule	0.25 ... 1.5 mm ²
Fine-stranded conductor; with uninsulated ferrule	0.25 ... 2.5 mm ²
Strip length	8 ... 9 mm / 0.31 ... 0.35 inches
Pole number	2
Conductor entry direction to mating direction	270 °

Physical data

Pin spacing	5 mm / 0.197 inches
Width	12.4 mm / 0.488 inches
Height	23.9 mm / 0.941 inches
Depth	22.75 mm / 0.896 inches

Mechanical data

Variable coding	Yes
Design	angled
Anti-rotation protection	Yes

Plug-in connection

Contact type (pluggable connector)	Female connector/socket
Connector (connection type)	for conductor
Mismatching protection	No

Material data

Note (material data)	Information on material specifications can be found here
Color	gray
Material group	I
Insulation material	Polyamide (PA66)
Flammability class per UL94	V0
Clamping spring material	Chrome-nickel spring steel (CrNi)
Contact material	Copper alloy
Contact plating	Tin
Fire load	0.087 MJ
Weight	3.9 g

Environmental requirements

Limit temperature range	-60 ... +85 °C
Processing temperature	-35 ... +60 °C

Commercial data

Product Group	3 (Multi Conn. System)
eCl@ss 10.0	27-44-03-09
eCl@ss 9.0	27-44-03-09
ETIM 8.0	EC002638
ETIM 7.0	EC002638
PU (SPU)	100 pcs
Packaging type	Box
Country of origin	PL
GTIN	4044918383745
Customs tariff number	85366990990

Environmental Product Compliance

RoHS Compliance Status	Compliant, No Exemption
------------------------	-------------------------

Approvals / Certificates

General approvals



Approval	Standard	Certificate Name
CB DEKRA Certification B.V.	IEC 61984	NL-39756/A1
CSA DEKRA Certification B.V.	C22.2	1466354
KEMA/KEUR DEKRA Certification B.V.	EN 61984	71-121453
UL Underwriters Laboratories Inc.	UL 1059	E45172

General approvals

UR Underwriters Laboratories Inc.	UL 1977	E45171
--------------------------------------	---------	--------

Approvals for marine applications



Approval	Standard	Certificate Name
ABS American Bureau of Ship- ping	-	19-HG15869876-PDA
BV Bureau Veritas S.A.	IEC 60998	11915/D0 BV
DNV DNV GL SE	-	TAE000016Z

Downloads

Environmental Product Compliance

Compliance Search
Environmental Product Compliance 232-102/026-000

Documentation

Additional Information			
Technical Section	03.04.2019	pdf 2010.85 KB	

CAD/CAE-Data

CAD data
2D/3D Models 232-102/026-000

CAE data
EPLAN Data Portal 232-102/026-000
ZUKEN Portal 232-102/026-000

1 Compatible Products

1.1 System counterpart

1.1.1 Male connector/plug



Item No.: 231-602
1-conductor male connector; CAGE
CLAMP®; 2.5 mm²; Pin spacing 5 mm; 2-
pole; 2,50 mm²; gray

Item No.: 231-432/001-000
THT male header; 1.0 x 1.0 mm solder pin;
angled; Pin spacing 5 mm; 2-pole; gray

Item No.: 231-132/001-000
THT male header; 1.0 x 1.0 mm solder pin;
straight; Pin spacing 5 mm; 2-pole; gray

1.2 Optional Accessories

1.2.1 Cover

1.2.1.1 Cover



Item No.: 231-668

Lockout caps; for covering unused clamping units; gray

1.2.2 Ferrule

1.2.2.1 Ferrule



Item No.: 216-301

Ferrule; Sleeve for 0.25 mm² / AWG 24; insulated; electro-tin plated; yellow



Item No.: 216-321

Ferrule; Sleeve for 0.25 mm² / AWG 24; insulated; electro-tin plated; yellow



Item No.: 216-151

Ferrule; Sleeve for 0.25 mm² / AWG 24; uninsulated; electro-tin plated



Item No.: 216-131

Ferrule; Sleeve for 0.25 mm² / AWG 24; uninsulated; electro-tin plated; silver-colored



Item No.: 216-302

Ferrule; Sleeve for 0.34 mm² / 22 AWG; insulated; electro-tin plated; light turquoise



Item No.: 216-322

Ferrule; Sleeve for 0.34 mm² / 22 AWG; insulated; electro-tin plated; light turquoise



Item No.: 216-132

Ferrule; Sleeve for 0.34 mm² / AWG 24; uninsulated; electro-tin plated



Item No.: 216-152

Ferrule; Sleeve for 0.34 mm² / AWG 24; uninsulated; electro-tin plated



Item No.: 216-241

Ferrule; Sleeve for 0.5 mm² / 20 AWG; insulated; electro-tin plated; electrolytic copper; gastight crimped; acc. to DIN 46228, Part 4/09.90; white



Item No.: 216-201

Ferrule; Sleeve for 0.5 mm² / 20 AWG; insulated; electro-tin plated; white



Item No.: 216-221

Ferrule; Sleeve for 0.5 mm² / 20 AWG; insulated; electro-tin plated; white



Item No.: 216-141

Ferrule; Sleeve for 0.5 mm² / 20 AWG; uninsulated; electro-tin plated; electrolytic copper; gastight crimped; acc. to DIN 46228, Part 1/08.92



Item No.: 216-101

Ferrule; Sleeve for 0.5 mm² / AWG 22; uninsulated; electro-tin plated; silver-colored



Item No.: 216-121

Ferrule; Sleeve for 0.5 mm² / AWG 22; uninsulated; electro-tin plated; silver-colored



Item No.: 216-242

Ferrule; Sleeve for 0.75 mm² / 18 AWG; insulated; electro-tin plated; electrolytic copper; gastight crimped; acc. to DIN 46228, Part 4/09.90; gray



Item No.: 216-262

Ferrule; Sleeve for 0.75 mm² / 18 AWG; insulated; electro-tin plated; electrolytic copper; gastight crimped; acc. to DIN 46228, Part 4/09.90; gray



Item No.: 216-202

Ferrule; Sleeve for 0.75 mm² / 18 AWG; insulated; electro-tin plated; gray



Item No.: 216-222

Ferrule; Sleeve for 0.75 mm² / 18 AWG; insulated; electro-tin plated; gray



Item No.: 216-142

Ferrule; Sleeve for 0.75 mm² / 18 AWG; uninsulated; electro-tin plated; electrolytic copper; gastight crimped; acc. to DIN 46228, Part 1/08.92



Item No.: 216-102

Ferrule; Sleeve for 0.75 mm² / AWG 20; uninsulated; electro-tin plated; silver-colored



Item No.: 216-122

Ferrule; Sleeve for 0.75 mm² / AWG 20; uninsulated; electro-tin plated; silver-colored



Item No.: 216-243

Ferrule; Sleeve for 1 mm² / AWG 18; insulated; electro-tin plated; electrolytic copper; gastight crimped; acc. to DIN 46228, Part 4/09.90; red



Item No.: 216-263

Ferrule; Sleeve for 1 mm² / AWG 18; insulated; electro-tin plated; electrolytic copper; gastight crimped; acc. to DIN 46228, Part 4/09.90; red



Item No.: 216-203

Ferrule; Sleeve for 1 mm² / AWG 18; insulated; electro-tin plated; red



Item No.: 216-223

Ferrule; Sleeve for 1 mm² / AWG 18; insulated; electro-tin plated; red



Item No.: 216-103

Ferrule; Sleeve for 1 mm² / AWG 18; uninsulated; electro-tin plated



Item No.: 216-143

Ferrule; Sleeve for 1 mm² / AWG 18; uninsulated; electro-tin plated; electrolytic copper; gastight crimped; acc. to DIN 46228, Part 1/08.92



Item No.: 216-123

Ferrule; Sleeve for 1 mm² / AWG 18; uninsulated; electro-tin plated; silver-colored



Item No.: 216-204

Ferrule; Sleeve for 1.5 mm² / AWG 16; insulated; electro-tin plated; black



Item No.: 216-224

Ferrule; Sleeve for 1.5 mm² / AWG 16; insulated; electro-tin plated; black



Item No.: 216-244

Ferrule; Sleeve for 1.5 mm² / AWG 16; insulated; electro-tin plated; electrolytic copper; gastight crimped; acc. to DIN 46228, Part 4/09.90; black



Item No.: 216-264

Ferrule; Sleeve for 1.5 mm² / AWG 16; insulated; electro-tin plated; electrolytic copper; gastight crimped; acc. to DIN 46228, Part 4/09.90; black

1.2.2.1 Ferrule



Item No.: 216-284

Ferrule; Sleeve for 1.5 mm² / AWG 16; insulated; electro-tin plated; electrolytic copper; gastight crimped; acc. to DIN 46228, Part 4/09.90; black

Item No.: 216-124

Ferrule; Sleeve for 1.5 mm² / AWG 16; un-insulated; electro-tin plated

Item No.: 216-144

Ferrule; Sleeve for 1.5 mm² / AWG 16; un-insulated; electro-tin plated; electrolytic copper; gastight crimped; acc. to DIN 46228, Part 1/08.92; silver-colored

Item No.: 216-104

Ferrule; Sleeve for 1.5 mm² / AWG 16; un-insulated; electro-tin plated; silver-colored



Item No.: 216-106

Ferrule; Sleeve for 2.5 mm² / AWG 14; un-insulated; electro-tin plated; silver-colored

1.2.3 Insulation stop

1.2.3.1 Insulation stop



Item No.: 231-670

Insulation stop; 0.08-0.2 mm² / 0.2 mm² "s"; white

Item No.: 231-671

Insulation stop; 0.25 - 0.5 mm²; light gray

Item No.: 231-672

Insulation stop; 0.75 - 1 mm²; dark gray

1.2.4 Jumper

1.2.4.1 Jumper



Item No.: 231-902

Jumper; for conductor entry; 2-way; insulated; gray

1.2.5 Marking

1.2.5.1 Marking strip



Item No.: 210-331/500-103

Marking strips; as a DIN A4 sheet; MARKED; 1-12 (300x); Height of marker strip: 2.3 mm/0.091 in; Strip length 182 mm; Horizontal marking; Self-adhesive; white

Item No.: 210-332/500-202

Marking strips; as a DIN A4 sheet; MARKED; 1-16 (160x); Height of marker strip: 3 mm; Strip length 182 mm; Horizontal marking; Self-adhesive; white

Item No.: 210-332/500-205

Marking strips; as a DIN A4 sheet; MARKED; 1-32 (80x); Height of marker strip: 3 mm; Strip length 182 mm; Horizontal marking; Self-adhesive; white

Item No.: 210-331/500-104

Marking strips; as a DIN A4 sheet; MARKED; 13-24 (300x); Height of marker strip: 2.3 mm/0.091 in; Strip length 182 mm; Horizontal marking; Self-adhesive; white



Item No.: 210-332/500-204

Marking strips; as a DIN A4 sheet; MARKED; 17-32 (160x); Height of marker strip: 3 mm; Strip length 182 mm; Horizontal marking; Self-adhesive; white

Item No.: 210-332/500-206

Marking strips; as a DIN A4 sheet; MARKED; 33-48 (160x); Height of marker strip: 3 mm; Strip length 182 mm; Horizontal marking; Self-adhesive; white

1.2.6 Strain relief

1.2.6.1 Strain relief housing



Item No.: 232-602

Strain relief housing; for female and male connectors; 2 parts; Pin spacing 5 mm; 2-pole; gray

1.2.7 Test and measurement

1.2.7.1 Testing accessories



Item No.: 210-136

Test plug; 2 mm Ø; with 500 mm cable; red



Item No.: 231-661

Test plugs for female connectors; for 5 mm and 5.08 mm pin spacing; 2,50 mm²; light gray

1.2.8 Tool

1.2.8.1 Operating tool



Item No.: 231-231

Combination operating tool; red



Item No.: 209-130

Operating tool; made of insulating material; 1-way; for 264 Series (1-/2-way), 280, 281 Series (up to 3-way); natural



Item No.: 231-291

Operating tool; made of insulating material; 1-way; loose; red



Item No.: 231-131

Operating tool; made of insulating material; 1-way; loose; white



Item No.: 280-432

Operating tool; made of insulating material; 2-way; white



Item No.: 231-159

Operating tool; natural

Installation Notes

Conductor termination

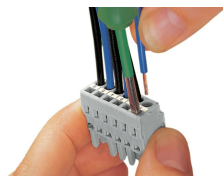

Inserting a conductor via 3.5 mm screwdriver – CAGE CLAMP® actuation parallel to conductor entry.

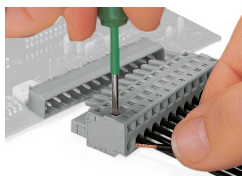

Inserting a conductor via 3.5 mm screwdriver – CAGE CLAMP® actuation perpendicular to conductor entry.

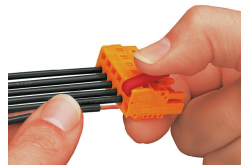

Inserting a conductor into CAGE CLAMP® unit via operating tool (231-291).



Inserting a conductor via operating tool.

Coding



Coding a female connector by removing coding finger(s).

Testing

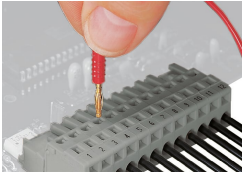

Testing – female connector with CAGE CLAMP®
Integrated test ports for testing perpendicular to conductor entry via 2 or 2.3 mm Ø test plug

Installation

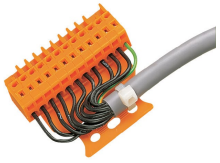

Male connector with strain relief plate



Strain relief housing shown with a male connector equipped with CAGE CLAMP®

Marking

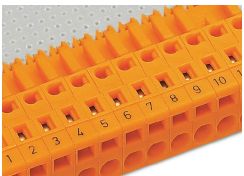

Labeling via direct marking or self-adhesive strips.