

# Data Sheet | Item Number: 765-1502/100-000

16-channel digital input/output; EtherNet/IP; DC 24 V / 2.0 A; 8xM12 connection; WideLine

<https://www.wago.com/765-1502/100-000>



Similar to illustration

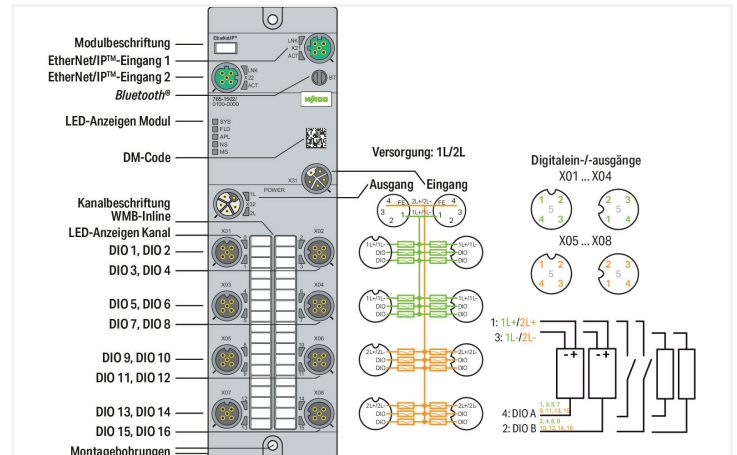

## Einsatzbereich:

Dezentrale Verarbeitung von Digitalsignalen.

Das Gerät dient zur Erfassung und Ansteuerung digitaler Feldgeräte, z. B. von Sensoren und Aktoren, die von einer übergeordneten Steuerung empfangen bzw. angesteuert werden.

Das Gerät bietet 16 digitale Ein-/Ausgänge.

## Technical data

### Fieldbus

Communication	EtherNet/IP™ BOOTP, DHCP, DLR
Connection technology: communication/fieldbus	2 x D-coded M12; 4-pole
Interface standard	10BASE-T/100BASE-TX; potential-free
Autonegotiation; autocrossover	Yes

### Device functions

Parameter	Input filter Output current Temperature
Diagnostics	Undervoltage; overcurrent; overload; overtemperature
Device functions	Bluetooth® OPC UA server
Visualization	Android/iOS app Web server

### Digital inputs/outputs

Number of digital inputs	16
Number of digital outputs	16
Connection technology: inputs/outputs	8 x A-coded M12; 5-pole
Signal type (voltage)	24 VDC
Input characteristic	high-side switching Type 3, per IEC 61131-2
Input filter	0.2 ... 20 ms
Output current (per channel)	2 A (typ.) for DO
Supply current per port	1L/2L: 4 A (max.)

### Supply (module)

Connection technology: supply	2 x L-coded M12; 5-pole
Supply voltage	24 VDC (18 ... 31.2 V); 1L/2L
Current consumption (max.)	16000 mA
Current consumption (note)	per supply line; overload- and short-circuit-protected
Reverse voltage protection	Yes

### Physical data

Width	60 mm / 2.362 inches
Height	30 mm / 1.181 inches
Depth	210 mm / 8.268 inches

### Mechanical data

Weight	610 g
Conformity marking	CE

### Environmental requirements

Ambient temperature (operation)	-25 ... +70 °C
Ambient temperature (storage)	-40 ... +80 °C
Protection type	IP67
Protection class	III per EN 61140, IEC 61140, VDE 0140-1
Operating altitude	0 ... 2000 m / 0 ... 6562 ft
Pollution degree	3 (EN 60664-1)
Overvoltage category	II (EN 60664-1)
Relative humidity (without condensation)	95 %
Vibration resistance	5g per IEC 60068-2-6
Shock resistance	Short-term: 50g/11 ms/half-sine per IEC 60068-2-27; Long-term: 30g/6 ms/half-sine per IEC 60068-2-29
EMC immunity to interference	per EN 61000-6-2
EMC emission of interference	per EN 61000-6-4

### Commercial data

ETIM 8.0	EC001599
ETIM 7.0	EC001599
PU (SPU)	1 pcs
Country of origin	DE
GTIN	4066966063080
Customs tariff number	85371098990

### Environmental Product Compliance

RoHS Compliance Status	Compliant, No Exemption
------------------------	-------------------------

### Approvals / Certificates

#### General approvals



Approval	Standard	Certificate Name
KC National Radio Research Agency	Article 58-2, Clause 3	KC R-R-W43-FB765

## Downloads

### Environmental Product Compliance

#### Compliance Search

Environmental Product Compliance  
765-1502/100-000



## Documentation

### Manual

Product Manual 16-Channel Digital Input/Output; EtherNet/IP V 2.0.0  
19.07.2022 pdf  
7844.18 KB



### System Description

WAGO I/O System Field; General Product Information pdf  
1009.23 KB



## CAD/CAE-Data

### CAD data

2D/3D Models  
765-1502/100-000



### CAE data

EPLAN Data Portal  
765-1502/100-000



## Runtime Software

### Firmware

0765-x5xx, Ethernet/IP IO-Field V 04  
02.02.2023 zip  
1546.91 KB



## Libraries

### Device Description File

750-915; EDS-Dateien for EthernetIP / Serie 750, 765 and 767 12  
09.07.2021 zip  
164.42 KB



Gerätebeschreibungsdateien 765-45xx, 765-15xx, EtherNet/IP V1\_1\_0\_22  
zip  
74.02 KB



## 1 Compatible Products

### 1.1 Required Accessories

#### 1.1.1 Cover

##### 1.1.1.1 Cover



[Item No.: 756-8103](#)

M12 protective cap; for unused plugs

[Item No.: 756-8102](#)

M12 protective cap; for unused sockets

## 1.1.2 Marking

### 1.1.2.1 Marker



**Item No.: 2009-115**

WMB-Inline; for Smart Printer; 1500 pieces on roll; stretchable 5 - 5.2 mm; plain; snap-on type; white

### 1.1.2.2 Marking strip



**Item No.: 2009-110**

Marking strips; for Smart Printer; on reel; not stretchable; plain; snap-on type; white

## 1.1.3 Tool

### 1.1.3.1 Assembly tool



**Item No.: 206-701**

Torque wrench M8 and M12; Assembly kit

## 1.2 Optional Accessories

### 1.2.1 Cables and connectors

#### 1.2.1.1 Adapter



**Item No.: 756-9503/040-000**

Accessories; 4-pole



**Item No.: 756-9504/040-000**

Accessories; 4-pole

#### 1.2.1.2 Configurable connector



**Item No.: 756-9205/040-000**

Fitted pluggable connector; 4-pole; M12 plug, right angle; Spring



**Item No.: 756-9202/040-000**

Fitted pluggable connector; 4-pole; M12 plug, straight, A-coded; Spring



**Item No.: 756-9701/050-000**

Fitted pluggable connector; 5-pole, shielded; M12 plug, straight; IDC technology



**Item No.: 756-9711/050-000**

Fitted pluggable connector; 5-pole, shielded; M12 socket, straight; IDC technology

#### 1.2.1.3 Configurable shielded connector



**Item No.: 756-9501/040-000**

Accessories; M12 plug, right angle; 4-pole



**Item No.: 756-9501/060-000**

Fitted pluggable connector; 4-pole, shielded; M12 plug, straight, D-coded; Spring













1.2.1.4 Distribution connector

 <p><b>Item No.: 756-9301/040-000</b> Accessories; 4-pole</p>	 <p><b>Item No.: 756-9301/050-000</b> Accessories; 5-pole</p>	 <p><b>Item No.: 756-5517/040-010</b> Sensor/Actuator cable; 2xM12 socket; angled; M12A plug; straight; 4-pole; Length: 1 m</p>	 <p><b>Item No.: 756-5517/040-020</b> Sensor/Actuator cable; 2xM12 socket; angled; M12A plug; straight; 4-pole; Length: 2 m</p>
 <p><b>Item No.: 756-5516/040-010</b> Sensor/Actuator cable; 2xM12 socket; straight; M12A plug; straight; 4-pole; Length: 1 m</p>	 <p><b>Item No.: 756-5516/040-020</b> Sensor/Actuator cable; 2xM12 socket; straight; M12A plug; straight; 4-pole; Length: 2 m</p>	 <p><b>Item No.: 756-5514/040-010</b> Sensor/Actuator cable; 2xM8 socket; angled; M12A plug; straight; 4-pole; Length: 1 m</p>	 <p><b>Item No.: 756-5514/040-020</b> Sensor/Actuator cable; 2xM8 socket; angled; M12A plug; straight; 4-pole; Length: 2 m</p>
 <p><b>Item No.: 756-5513/040-010</b> Sensor/Actuator cable; 2xM8 socket; straight; M12A plug; straight; 4-pole; Length: 1 m</p>	 <p><b>Item No.: 756-5513/040-020</b> Sensor/Actuator cable; 2xM8 socket; straight; M12A plug; straight; 4-pole; Length: 2 m</p>		

1.2.1.5 ETHERNET/PROFINET cable

 <p><b>Item No.: 756-1202/060-100</b> ETHERNET cable; M12D plug; angled; 4-pole; Length: 10 m</p>	 <p><b>Item No.: 756-1202/060-020</b> ETHERNET cable; M12D plug; angled; 4-pole; Length: 2 m</p>	 <p><b>Item No.: 756-1202/060-200</b> ETHERNET cable; M12D plug; angled; 4-pole; Length: 20 m</p>	 <p><b>Item No.: 756-1202/060-050</b> ETHERNET cable; M12D plug; angled; 4-pole; Length: 5 m</p>
 <p><b>Item No.: 756-1204/060-010</b> ETHERNET cable; M12D plug; angled; M12D plug; angled; 4-pole; Length: 1 m</p>	 <p><b>Item No.: 756-1204/060-100</b> ETHERNET cable; M12D plug; angled; M12D plug; angled; 4-pole; Length: 10 m</p>	 <p><b>Item No.: 756-1204/060-020</b> ETHERNET cable; M12D plug; angled; M12D plug; angled; 4-pole; Length: 2 m</p>	 <p><b>Item No.: 756-1204/060-200</b> ETHERNET cable; M12D plug; angled; M12D plug; angled; 4-pole; Length: 20 m</p>
 <p><b>Item No.: 756-1204/060-030</b> ETHERNET cable; M12D plug; angled; M12D plug; angled; 4-pole; Length: 3 m</p>	 <p><b>Item No.: 756-1204/060-050</b> ETHERNET cable; M12D plug; angled; M12D plug; angled; 4-pole; Length: 5 m</p>	 <p><b>Item No.: 756-1201/060-100</b> ETHERNET cable; M12D plug; straight; 4-pole; Length: 10 m</p>	 <p><b>Item No.: 756-1201/060-020</b> ETHERNET cable; M12D plug; straight; 4-pole; Length: 2 m</p>
 <p><b>Item No.: 756-1201/060-200</b> ETHERNET cable; M12D plug; straight; 4-pole; Length: 20 m</p>	 <p><b>Item No.: 756-1201/060-050</b> ETHERNET cable; M12D plug; straight; 4-pole; Length: 5 m</p>	 <p><b>Item No.: 756-1203/060-100</b> ETHERNET cable; M12D plug; straight; M12D plug; straight; 4-pole; Length: 10 m</p>	 <p><b>Item No.: 756-1203/060-020</b> ETHERNET cable; M12D plug; straight; M12D plug; straight; 4-pole; Length: 2 m</p>
 <p><b>Item No.: 756-1203/060-200</b> ETHERNET cable; M12D plug; straight; M12D plug; straight; 4-pole; Length: 20 m</p>	 <p><b>Item No.: 756-1203/060-050</b> ETHERNET cable; M12D plug; straight; M12D plug; straight; 4-pole; Length: 5 m</p>		

1.2.1.6 Power cable

 <p><b>Item No.: 756-3504/050-100</b> Power cable; M12L plug; angled; 5-pole; Length: 10 m</p>	 <p><b>Item No.: 756-3504/050-150</b> Power cable; M12L plug; angled; 5-pole; Length: 15 m</p>	 <p><b>Item No.: 756-3504/050-020</b> Power cable; M12L plug; angled; 5-pole; Length: 2 m</p>	 <p><b>Item No.: 756-3504/050-050</b> Power cable; M12L plug; angled; 5-pole; Length: 5 m</p>
 <p><b>Item No.: 756-3504/050-075</b> Power cable; M12L plug; angled; 5-pole; Length: 7.5 m</p>	 <p><b>Item No.: 756-3503/050-100</b> Power cable; M12L plug; straight; 5-pole; Length: 10 m</p>	 <p><b>Item No.: 756-3503/050-150</b> Power cable; M12L plug; straight; 5-pole; Length: 15 m</p>	 <p><b>Item No.: 756-3503/050-020</b> Power cable; M12L plug; straight; 5-pole; Length: 2 m</p>
 <p><b>Item No.: 756-3503/050-050</b> Power cable; M12L plug; straight; 5-pole; Length: 5 m</p>	 <p><b>Item No.: 756-3502/050-075</b> Power cable; M12L socket; angled; 5-pole; Length: 7.5 m</p>	 <p><b>Item No.: 756-3502/050-100</b> Power cable; M12L socket; angled; 5-pole; Length: 10 m</p>	 <p><b>Item No.: 756-3502/050-150</b> Power cable; M12L socket; angled; 5-pole; Length: 15 m</p>

1.2.1.6 Power cable

 <b>Item No.: 756-3502/050-020</b> Power cable; M12L socket; angled; 5-pole; Length: 2 m	 <b>Item No.: 756-3502/050-050</b> Power cable; M12L socket; angled; 5-pole; Length: 5 m	 <b>Item No.: 756-3502/050-075</b> Power cable; M12L socket; angled; 5-pole; Length: 7.5 m	 <b>Item No.: 756-3506/050-003</b> Power cable; M12L socket; angled; M12L plug; angled; 5-pole; Length: 0.3 m
 <b>Item No.: 756-3506/050-005</b> Power cable; M12L socket; angled; M12L plug; angled; 5-pole; Length: 0.5 m	 <b>Item No.: 756-3506/050-010</b> Power cable; M12L socket; angled; M12L plug; angled; 5-pole; Length: 1 m	 <b>Item No.: 756-3506/050-100</b> Power cable; M12L socket; angled; M12L plug; angled; 5-pole; Length: 10 m	 <b>Item No.: 756-3506/050-150</b> Power cable; M12L socket; angled; M12L plug; angled; 5-pole; Length: 15 m
 <b>Item No.: 756-3506/050-020</b> Power cable; M12L socket; angled; M12L plug; angled; 5-pole; Length: 2 m	 <b>Item No.: 756-3506/050-050</b> Power cable; M12L socket; angled; M12L plug; angled; 5-pole; Length: 5 m	 <b>Item No.: 756-3506/050-075</b> Power cable; M12L socket; angled; M12L plug; angled; 5-pole; Length: 7.5 m	 <b>Item No.: 756-3501/050-100</b> Power cable; M12L socket; straight; 5-pole; Length: 10 m
 <b>Item No.: 756-3501/050-150</b> Power cable; M12L socket; straight; 5-pole; Length: 15 m	 <b>Item No.: 756-3501/050-020</b> Power cable; M12L socket; straight; 5-pole; Length: 2 m	 <b>Item No.: 756-3501/050-050</b> Power cable; M12L socket; straight; 5-pole; Length: 5 m	 <b>Item No.: 756-3501/050-075</b> Power cable; M12L socket; straight; 5-pole; Length: 7.5 m
 <b>Item No.: 756-3505/050-003</b> Power cable; M12L socket; straight; M12L plug; straight; 5-pole; Length: 0.3 m	 <b>Item No.: 756-3505/050-005</b> Power cable; M12L socket; straight; M12L plug; straight; 5-pole; Length: 0.5 m	 <b>Item No.: 756-3505/050-010</b> Power cable; M12L socket; straight; M12L plug; straight; 5-pole; Length: 1 m	 <b>Item No.: 756-3505/050-100</b> Power cable; M12L socket; straight; M12L plug; straight; 5-pole; Length: 10 m
 <b>Item No.: 756-3505/050-150</b> Power cable; M12L socket; straight; M12L plug; straight; 5-pole; Length: 15 m	 <b>Item No.: 756-3505/050-020</b> Power cable; M12L socket; straight; M12L plug; straight; 5-pole; Length: 2 m	 <b>Item No.: 756-3505/050-050</b> Power cable; M12L socket; straight; M12L plug; straight; 5-pole; Length: 5 m	 <b>Item No.: 756-3505/050-075</b> Power cable; M12L socket; straight; M12L plug; straight; 5-pole; Length: 7.5 m

1.2.1.7 Sensor/actuator cable

 <b>Item No.: 756-5312/040-015</b> Sensor/Actuator cable; M12A plug; angled; 4-pole; Length: 1.5 m	 <b>Item No.: 756-5312/040-100</b> Sensor/Actuator cable; M12A plug; angled; 4-pole; Length: 10 m	 <b>Item No.: 756-5312/040-050</b> Sensor/Actuator cable; M12A plug; angled; 4-pole; Length: 5 m	 <b>Item No.: 756-5311/040-015</b> Sensor/Actuator cable; M12A plug; straight; 4-pole; Length: 1.5 m
 <b>Item No.: 756-5311/040-100</b> Sensor/Actuator cable; M12A plug; straight; 4-pole; Length: 10 m	 <b>Item No.: 756-5311/040-050</b> Sensor/Actuator cable; M12A plug; straight; 4-pole; Length: 5 m	 <b>Item No.: 756-5404/040-010</b> Sensor/Actuator cable; M12A socket; angled; M12A plug; angled; 4-pole; Length: 1 m	 <b>Item No.: 756-5404/040-020</b> Sensor/Actuator cable; M12A socket; angled; M12A plug; angled; 4-pole; Length: 2 m
 <b>Item No.: 756-5403/040-010</b> Sensor/Actuator cable; M12A socket; angled; M12A plug; straight; 4-pole; Length: 1 m	 <b>Item No.: 756-5403/040-020</b> Sensor/Actuator cable; M12A socket; angled; M12A plug; straight; 4-pole; Length: 2 m	 <b>Item No.: 756-5402/040-010</b> Sensor/Actuator cable; M12A socket; straight; M12A plug; angled; 4-pole; Length: 1 m	 <b>Item No.: 756-5402/040-020</b> Sensor/Actuator cable; M12A socket; straight; M12A plug; angled; 4-pole; Length: 2 m
 <b>Item No.: 756-5401/040-010</b> Sensor/Actuator cable; M12A socket; straight; M12A plug; straight; 4-pole; Length: 1 m	 <b>Item No.: 756-5401/040-020</b> Sensor/Actuator cable; M12A socket; straight; M12A plug; straight; 4-pole; Length: 2 m	 <b>Item No.: 756-5510/040-010</b> Sensor/Actuator cable; M8 socket; angled; M12A plug; angled; 4-pole; Length: 1 m	 <b>Item No.: 756-5510/040-020</b> Sensor/Actuator cable; M8 socket; angled; M12A plug; angled; 4-pole; Length: 2 m
 <b>Item No.: 756-5509/040-010</b> Sensor/Actuator cable; M8 socket; angled; M12A plug; straight; 4-pole; Length: 1 m	 <b>Item No.: 756-5509/040-020</b> Sensor/Actuator cable; M8 socket; angled; M12A plug; straight; 4-pole; Length: 2 m	 <b>Item No.: 756-5508/040-010</b> Sensor/Actuator cable; M8 socket; straight; M12A plug; angled; 4-pole; Length: 1 m	 <b>Item No.: 756-5508/040-020</b> Sensor/Actuator cable; M8 socket; straight; M12A plug; angled; 4-pole; Length: 2 m

1.2.1.7 Sensor/actuator cable



Item No.: 756-5507/040-010

Sensor/Actuator cable; M8 socket;  
straight; M12A plug; straight; 4-pole;  
Length: 1 m

Item No.: 756-5507/040-020

Sensor/Actuator cable; M8 socket;  
straight; M12A plug; straight; 4-pole;  
Length: 2 m