

Data Sheet | Item Number: 765-1505/100-000

8-channel digital input/output; EtherNet/IP; DC 24 V / 2.0 A; 8xM8 connection; Slim-Line

<https://www.wago.com/765-1505/100-000>



Similar to illustration

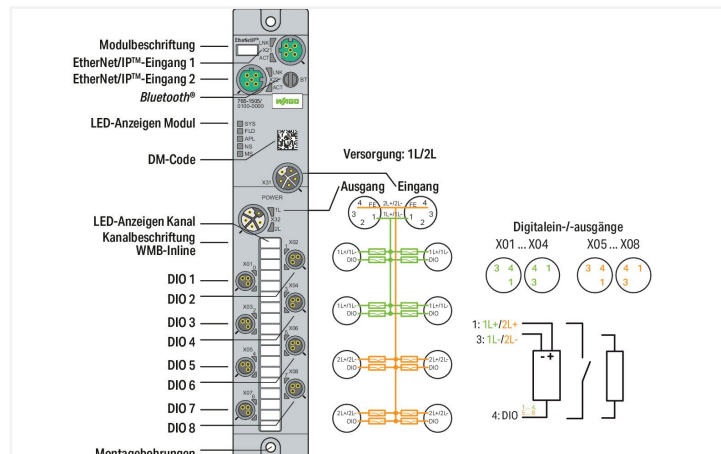

Einsatzbereich:

Dezentrale Verarbeitung von Digitalsignalen.

Das Gerät dient zur Erfassung und Ansteuerung digitaler Feldgeräte, z. B. von Sensoren und Aktoren, die von einer übergeordneten Steuerung empfangen bzw. angesteuert werden.

Das Gerät bietet 8 digitale Ein-/Ausgänge.

Technical data

Fieldbus

Communication	EtherNet/IP™ BOOTP, DHCP, DLR
Connection technology: communication/fieldbus	2 x D-coded M12; 4-pole
Interface standard	10BASE-T/100BASE-TX; potential-free
Autonegotiation; autocrossover	Yes

Device functions

Parameter	Input filter Output current Temperature
Diagnostics	Undervoltage; overcurrent; overload; overtemperature
Device functions	Bluetooth® OPC UA server
Visualization	Android/iOS app Web server

Digital inputs/outputs

Number of digital inputs	8
Number of digital outputs	8
Connection technology: inputs/outputs	8 x M8; 3-pole
Signal type (voltage)	24 VDC
Input characteristic	high-side switching Type 3, per IEC 61131-2
Input filter	0.2 ... 20 ms
Output current (per channel)	2 A (typ.) for DO
Supply current per port	1L/2L: 4 A (max.)

Supply (module)

Connection technology: supply	2 x L-coded M12; 5-pole
Supply voltage	24 VDC (18 ... 31.2 V); 1L/2L
Current consumption (max.)	16000 mA
Current consumption (note)	per supply line; overload- and short-circuit-protected
Reverse voltage protection	Yes

Physical data

Width	35 mm / 1.378 inches
Height	30 mm / 1.181 inches
Depth	210 mm / 8.268 inches

Mechanical data

Weight	390 g
Conformity marking	CE

Environmental requirements

Ambient temperature (operation)	-25 ... +70 °C
Ambient temperature (storage)	-40 ... +80 °C
Protection type	IP67
Protection class	III per EN 61140, IEC 61140, VDE 0140-1
Operating altitude	0 ... 2000 m / 0 ... 6562 ft
Pollution degree	3 (EN 60664-1)
Overvoltage category	II (EN 60664-1)
Relative humidity (without condensation)	95 %
Vibration resistance	5g per IEC 60068-2-6
Shock resistance	Short-term: 50g/11 ms/half-sine per IEC 60068-2-27; Long-term: 30g/6 ms/half-sine per IEC 60068-2-29
EMC immunity to interference	per EN 61000-6-2
EMC emission of interference	per EN 61000-6-4

Commercial data

ETIM 8.0	EC001599
ETIM 7.0	EC001599
PU (SPU)	1 pcs
Country of origin	DE
GTIN	4066966063127
Customs tariff number	85371098990

Environmental Product Compliance

RoHS Compliance Status	Compliant, No Exemption
------------------------	-------------------------

Approvals / Certificates

General approvals



Approval	Standard	Certificate Name
KC National Radio Research Agency	Article 58-2, Clause 3	KC R-R-W43-FB765

Downloads

Environmental Product Compliance

Compliance Search

Environmental Product Compliance
765-1505/100-000



Documentation

Manual

Product Manual 8-Channel Digital Input/Output; EtherNet/IP V 2.0.0
19.07.2022 pdf
7204.09 KB



System Description

WAGO I/O System Field; General Product Information pdf
1009.23 KB



CAD/CAE-Data

CAD data

2D/3D Models
765-1505/100-000



CAE data

EPLAN Data Portal
765-1505/100-000



Runtime Software

Firmware

0765-x5xx, Ethernet/IP IO-Field V 04
02.02.2023 zip
1546.91 KB



Libraries

Device Description File

750-915; EDS-Dateien for EthernetIP / Serie 750, 765 and 767 12
09.07.2021 zip
164.42 KB



Gerätebeschreibungsdateien 765-45xx, 765-15xx, EtherNet/IP V1_1_0_22
zip
74.02 KB



1 Compatible Products

1.1 Required Accessories

1.1.1 Cover

1.1.1.1 Cover



[Item No.: 756-8103](#)

M12 protective cap; for unused plugs

[Item No.: 756-8102](#)

M12 protective cap; for unused sockets

[Item No.: 756-8101](#)

M8 protective cap; for unused sockets

1.1.2 Marking

1.1.2.1 Marker



Item No.: [2009-115](#)

WMB-Inline; for Smart Printer; 1500 pieces on roll; stretchable 5 - 5.2 mm; plain; snap-on type; white

1.1.2.2 Marking strip



Item No.: [2009-110](#)

Marking strips; for Smart Printer; on reel; not stretchable; plain; snap-on type; white

1.1.3 Tool

1.1.3.1 Assembly tool



Item No.: [206-701](#)

Torque wrench M8 and M12; Assembly kit

1.2 Optional Accessories

1.2.1 Cables and connectors

1.2.1.1 Adapter



Item No.: [756-9503/040-000](#)

Accessories; 4-pole



Item No.: [756-9504/040-000](#)

Accessories; 4-pole

1.2.1.2 Configurable connector



Item No.: [756-9105/030-000](#)

Fitted pluggable connector; 3-pole; M8 plug, right angle; IDC technology



Item No.: [756-9102/030-000](#)

Fitted pluggable connector; 3-pole; M8 plug, straight; IDC technology



Item No.: [756-9701/050-000](#)

Fitted pluggable connector; 5-pole, shielded; M12 plug, straight; IDC technology



Item No.: [756-9711/050-000](#)

Fitted pluggable connector; 5-pole, shielded; M12 socket, straight; IDC technology

1.2.1.3 Configurable shielded connector



Item No.: [756-9501/040-000](#)

Accessories; M12 plug, right angle; 4-pole































Item No.: [756-9501/060-000](#)

Fitted pluggable connector; 4-pole, shielded; M12 plug, straight, D-coded; Spring

1.2.1.4 ETHERNET/PROFINET cable

 Item No.: 756-1202/060-100 ETHERNET cable; M12D plug; angled; 4-pole; Length: 10 m	 Item No.: 756-1202/060-020 ETHERNET cable; M12D plug; angled; 4-pole; Length: 2 m	 Item No.: 756-1202/060-200 ETHERNET cable; M12D plug; angled; 4-pole; Length: 20 m	 Item No.: 756-1202/060-050 ETHERNET cable; M12D plug; angled; 4-pole; Length: 5 m
 Item No.: 756-1204/060-010 ETHERNET cable; M12D plug; angled; M12D plug; angled; 4-pole; Length: 1 m	 Item No.: 756-1204/060-100 ETHERNET cable; M12D plug; angled; M12D plug; angled; 4-pole; Length: 10 m	 Item No.: 756-1204/060-020 ETHERNET cable; M12D plug; angled; M12D plug; angled; 4-pole; Length: 2 m	 Item No.: 756-1204/060-200 ETHERNET cable; M12D plug; angled; M12D plug; angled; 4-pole; Length: 20 m
 Item No.: 756-1204/060-030 ETHERNET cable; M12D plug; angled; M12D plug; angled; 4-pole; Length: 3 m	 Item No.: 756-1204/060-050 ETHERNET cable; M12D plug; angled; M12D plug; angled; 4-pole; Length: 5 m	 Item No.: 756-1201/060-100 ETHERNET cable; M12D plug; straight; 4-pole; Length: 10 m	 Item No.: 756-1201/060-020 ETHERNET cable; M12D plug; straight; 4-pole; Length: 2 m
 Item No.: 756-1201/060-200 ETHERNET cable; M12D plug; straight; 4-pole; Length: 20 m	 Item No.: 756-1201/060-050 ETHERNET cable; M12D plug; straight; 4-pole; Length: 5 m	 Item No.: 756-1203/060-100 ETHERNET cable; M12D plug; straight; M12D plug; straight; 4-pole; Length: 10 m	 Item No.: 756-1203/060-020 ETHERNET cable; M12D plug; straight; M12D plug; straight; 4-pole; Length: 2 m
 Item No.: 756-1203/060-200 ETHERNET cable; M12D plug; straight; M12D plug; straight; 4-pole; Length: 20 m	 Item No.: 756-1203/060-050 ETHERNET cable; M12D plug; straight; M12D plug; straight; 4-pole; Length: 5 m		

1.2.1.5 Power cable

 Item No.: 756-3504/050-100 Power cable; M12L plug; angled; 5-pole; Length: 10 m	 Item No.: 756-3504/050-150 Power cable; M12L plug; angled; 5-pole; Length: 15 m	 Item No.: 756-3504/050-020 Power cable; M12L plug; angled; 5-pole; Length: 2 m	 Item No.: 756-3504/050-050 Power cable; M12L plug; angled; 5-pole; Length: 5 m
 Item No.: 756-3504/050-075 Power cable; M12L plug; angled; 5-pole; Length: 7.5 m	 Item No.: 756-3503/050-100 Power cable; M12L plug; straight; 5-pole; Length: 10 m	 Item No.: 756-3503/050-150 Power cable; M12L plug; straight; 5-pole; Length: 15 m	 Item No.: 756-3503/050-020 Power cable; M12L plug; straight; 5-pole; Length: 2 m
 Item No.: 756-3503/050-050 Power cable; M12L plug; straight; 5-pole; Length: 5 m	 Item No.: 756-3503/050-075 Power cable; M12L plug; straight; 5-pole; Length: 7.5 m	 Item No.: 756-3502/050-100 Power cable; M12L socket; angled; 5-pole; Length: 10 m	 Item No.: 756-3502/050-150 Power cable; M12L socket; angled; 5-pole; Length: 15 m
 Item No.: 756-3502/050-020 Power cable; M12L socket; angled; 5-pole; Length: 2 m	 Item No.: 756-3502/050-050 Power cable; M12L socket; angled; 5-pole; Length: 5 m	 Item No.: 756-3502/050-075 Power cable; M12L socket; angled; 5-pole; Length: 7.5 m	 Item No.: 756-3506/050-003 Power cable; M12L socket; angled; M12L plug; angled; 5-pole; Length: 0.3 m
 Item No.: 756-3506/050-005 Power cable; M12L socket; angled; M12L plug; angled; 5-pole; Length: 0.5 m	 Item No.: 756-3506/050-010 Power cable; M12L socket; angled; M12L plug; angled; 5-pole; Length: 1 m	 Item No.: 756-3506/050-100 Power cable; M12L socket; angled; M12L plug; angled; 5-pole; Length: 10 m	 Item No.: 756-3506/050-150 Power cable; M12L socket; angled; M12L plug; angled; 5-pole; Length: 15 m
 Item No.: 756-3506/050-020 Power cable; M12L socket; angled; M12L plug; angled; 5-pole; Length: 2 m	 Item No.: 756-3506/050-050 Power cable; M12L socket; angled; M12L plug; angled; 5-pole; Length: 5 m	 Item No.: 756-3506/050-075 Power cable; M12L socket; angled; M12L plug; angled; 5-pole; Length: 7.5 m	 Item No.: 756-3501/050-100 Power cable; M12L socket; straight; 5-pole; Length: 10 m
 Item No.: 756-3501/050-150 Power cable; M12L socket; straight; 5-pole; Length: 15 m	 Item No.: 756-3501/050-020 Power cable; M12L socket; straight; 5-pole; Length: 2 m	 Item No.: 756-3501/050-050 Power cable; M12L socket; straight; 5-pole; Length: 5 m	 Item No.: 756-3501/050-075 Power cable; M12L socket; straight; 5-pole; Length: 7.5 m

1.2.1.5 Power cable



Item No.: 756-3505/050-003

Power cable; M12L socket; straight; M12L plug; straight; 5-pole; Length: 0.3 m

Item No.: 756-3505/050-005

Power cable; M12L socket; straight; M12L plug; straight; 5-pole; Length: 0.5 m

Item No.: 756-3505/050-010

Power cable; M12L socket; straight; M12L plug; straight; 5-pole; Length: 1 m

Item No.: 756-3505/050-100

Power cable; M12L socket; straight; M12L plug; straight; 5-pole; Length: 10 m



Item No.: 756-3505/050-150

Power cable; M12L socket; straight; M12L plug; straight; 5-pole; Length: 15 m

Item No.: 756-3505/050-020

Power cable; M12L socket; straight; M12L plug; straight; 5-pole; Length: 2 m

Item No.: 756-3505/050-050

Power cable; M12L socket; straight; M12L plug; straight; 5-pole; Length: 5 m

Item No.: 756-3505/050-075

Power cable; M12L socket; straight; M12L plug; straight; 5-pole; Length: 7.5 m

1.2.1.6 Sensor/actuator cable



Item No.: 756-5504/030-010

Sensor/Actuator cable; M12A socket; angled; M8 plug; angled; 3-pole; Length: 1 m

Item No.: 756-5504/030-020

Sensor/Actuator cable; M12A socket; angled; M8 plug; angled; 3-pole; Length: 2 m

Item No.: 756-5503/030-010

Sensor/Actuator cable; M12A socket; angled; M8 plug; straight; 3-pole; Length: 1 m

Item No.: 756-5503/030-020

Sensor/Actuator cable; M12A socket; angled; M8 plug; straight; 3-pole; Length: 2 m



Item No.: 756-5502/030-010

Sensor/Actuator cable; M12A socket; straight; M8 plug; angled; 3-pole; Length: 1 m

Item No.: 756-5502/030-020

Sensor/Actuator cable; M12A socket; straight; M8 plug; angled; 3-pole; Length: 2 m

Item No.: 756-5501/030-010

Sensor/Actuator cable; M12A socket; straight; M8 plug; straight; 3-pole; Length: 1 m

Item No.: 756-5501/030-020

Sensor/Actuator cable; M12A socket; straight; M8 plug; straight; 3-pole; Length: 2 m



Item No.: 756-5112/030-015

Sensor/Actuator cable; M8 plug; angled; 3-pole; Length: 1.5 m

Item No.: 756-5112/030-100

Sensor/Actuator cable; M8 plug; angled; 3-pole; Length: 10 m

Item No.: 756-5112/030-050

Sensor/Actuator cable; M8 plug; angled; 3-pole; Length: 5 m

Item No.: 756-5111/030-015

Sensor/Actuator cable; M8 plug; straight; 3-pole; Length: 1.5 m



Item No.: 756-5111/030-100

Sensor/Actuator cable; M8 plug; straight; 3-pole; Length: 10 m

Item No.: 756-5111/030-050

Sensor/Actuator cable; M8 plug; straight; 3-pole; Length: 5 m

Item No.: 756-5204/030-010

Sensor/Actuator cable; M8 socket; angled; M8 plug; angled; 3-pole; Length: 1 m

Item No.: 756-5204/030-020

Sensor/Actuator cable; M8 socket; angled; M8 plug; angled; 3-pole; Length: 2 m



Item No.: 756-5203/030-010

Sensor/Actuator cable; M8 socket; angled; M8 plug; straight; 3-pole; Length: 1 m

Item No.: 756-5203/030-020

Sensor/Actuator cable; M8 socket; angled; M8 plug; straight; 3-pole; Length: 2 m

Item No.: 756-5202/030-010

Sensor/Actuator cable; M8 socket; straight; M8 plug; angled; 3-pole; Length: 1 m

Item No.: 756-5202/030-020

Sensor/Actuator cable; M8 socket; straight; M8 plug; angled; 3-pole; Length: 2 m



Item No.: 756-5201/030-010

Sensor/Actuator cable; M8 socket; straight; M8 plug; straight; 3-pole; Length: 1 m

Item No.: 756-5201/030-020

Sensor/Actuator cable; M8 socket; straight; M8 plug; straight; 3-pole; Length: 2 m