

## Grooved End Fittings



Shurjoint ductile iron grooved-end fittings are made of ductile iron per ASTM A536 Gr. 65-45-12. C-E dimensions are manufacturer's standard.

Shurjoint wrought steel grooved-end fittings are available from 10" (250 mm) through 24" (600 mm) pipe sizes in a variety of styles. Fittings are fabricated with the carbon steel pipe to ASTM A234 Gr. WPB, standard weight (0.375" or 9.5 mm), or segmentally welded carbon steel of the same or equivalent grade. C-E dimensions conform to ANSI B16.9. Other styles not listed are available upon request.

Fitting pressure ratings are equivalent to the pressure ratings of the coupling used to install them. Coupling pressure ratings are pipe wall thickness dependent.

For pressure rating, listing, and approval information, refer to Data Sheet B-42 or visit SHURJOINT website, [www.shurjoint.com](http://www.shurjoint.com) for details or contact your SHURJOINT Representative

### material specification

- **Fitting Body:**  
Ductile Iron castings to ASTM A536, Gr. 65-45-12, min. tensile strength 65,000 psi (448 MPa).  
Fabricated with the carbon steel pipe to ASTM A234 Gr. WPB, standard weight (0.375" or 9.5 mm), or segmentally welded carbon steel of the same or equivalent grade.
- **Surface Finish:**  
Orange color painted or red RAL3000 color painted.
  - Hot dip galvanized (optional).
  - Epoxy coated in red RAL3000 or other colors (optional)

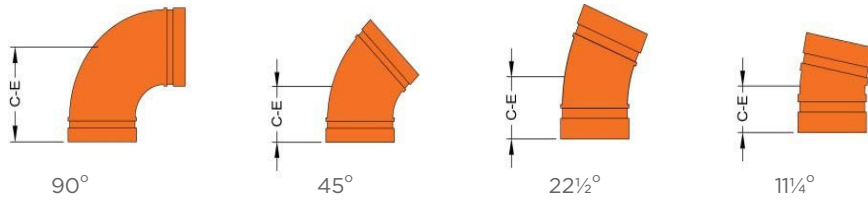

MODEL 7110 / 7111 / 7112 / 7113 ELBOWS

Normal Size	Pipe O.D.	#7110 90° Elbows		#7111 45° Elbows		#7112 22.5° Elbows		#7113 11.25° Elbows	
		C-E	weight	C-E	weight	C-E	weight	C-E	weight
in	in	in	lbs	in	lbs	in	lbs	in	lbs
mm	mm	mm	kg	mm	kg	mm	kg	mm	kg
1	1.315	2.25	0.7	1.75	0.5	--	--	1.38	0.4
25	33.4	57	0.3	45	0.2	--	--	35	0.2
1¼	1.660	2.75	1.1	1.75	0.7	1.75	0.7	1.38	0.7
32	42.2	70	0.5	45	0.3	45	0.3	35	0.3
1½	1.900	2.75	1.3	1.75	0.9	1.75	1.1	1.38	0.7
40	48.3	70	0.6	45	0.4	45	0.5	35	0.3
2	2.375	3.25	2.0	2.00	1.5	1.88	1.6	1.38	1.0
50	60.3	83	0.9	51	0.7	48	0.7	35	0.4
2½	2.875	3.75	2.6	2.25	2.1	2.01	2.6	1.50	1.6
65	73.0	95	1.2	57	0.9	51	1.2	38	0.7
76.1	3.000	3.75	3.1	2.25	2.1	2.01	2.5	1.50	1.7
	76.1	95	1.4	57	0.9	51	1.1	38	0.8
3	3.500	4.25	4.3	2.50	2.9	2.25	3.1	1.50	1.8
80	88.9	108	2.0	64	1.3	57	1.4	38	0.8
101.6	4.000	4.50	5.5	--	--	--	--	--	--
	101.6	114	2.5	--	--	--	--	--	--
108.0	4.250	5.00	5.5	3.00	4.4	--	--	--	--
	108.0	127	2.5	76	2.0	--	--	--	--
4	4.500	5.00	6.9	3.00	4.4	2.88	4.4	1.75	2.2
100	114.3	127	3.1	76	2.0	73	2.0	45	1.0
133.0	5.250	5.50	9.0	3.25	5.9	--	--	--	--
	133.0	140	4.1	83	2.7	--	--	--	--
139.7	5.500	5.50	9.5	3.25	6.4	2.88	6.5	2.00	4.5
	139.7	140	4.3	83	2.9	73	2.9	51	2.0
5	5.563	5.50	11.0	3.25	6.6	2.88	6.8	2.00	4.5
125	141.3	140	5.0	83	3.0	73	3.1	51	2.1

MODEL 7110 / 7111 / 7112 / 7113 ELBOWS

Normal Size	Pipe O.D.	#7110 90° Elbows		#7111 45° Elbows		#7112 22.5° Elbows		#7113 11.25° Elbows	
		C-E	weight	C-E	weight	C-E	weight	C-E	weight
in	in	in	lbs	in	lbs	in	lbs	in	lbs
mm	mm	mm	kg	mm	kg	mm	kg	mm	kg
159.0	6.250	6.50	13.2	3.50	8.4	--	--	--	--
	159.0	165	6.0	89	3.8	--	--	--	--
165.1	6.500	6.50	12.5	3.50	8.9	3.12	10.7	2.00	5.5
	165.1	165	5.7	89	4.0	79	4.9	51	2.5
6	6.625	6.50	12.8	3.50	8.9	3.12	9.3	2.00	5.5
150	168.3	165	5.8	89	4.0	79	4.2	51	2.5
8	8.625	7.75	28.7	4.25	19.0	3.88	17.8	2.00	10.1
200	219.1	197	13.0	108	8.6	98	8.1	51	4.6
10	10.750	9.00	53.1	4.75	34.2	4.38	39.0	2.13	22.1
250	273.0	229	24.1	121	15.5	111	17.7	54	10.0
12	12.750	10.00	81.0	5.25	49.5	4.88	43.0	2.25	27.3
300	323.9	254	36.7	133	22.5	124	19.5	57	12.4
200 JIS	8.516	7.75	27.2	4.25	18.5	3.88	13.9	2.00	9.3
	216.3	197	12.4	108	8.4	98	6.3	51	4.2
250 JIS	10.528	9.00	52.8	4.75	34.2	4.38	22.5	2.13	22.1
	267.4	229	24.0	121	15.5	111	10.2	54	10.0
300 JIS	12.539	10.00	77.0	5.25	49.5	4.88	33.7	2.25	27.3
	318.5	254	35.0	133	22.5	124	15.3	57	12.4

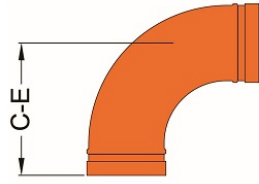

7110LR

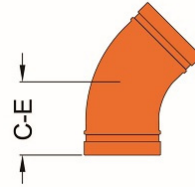

7111LR

Models 7110LR / 7111LR

Nominal Size	Pipe O.D.	#7110LR 1.5D LR 90° Elbows		#7111LR 1.5D LR 45° Elbows	
		C - E	Weight	C-LE	Weight
in	in	in	lbs	in	lbs
mm	mm	mm	kg	mm	kg
2	2.375	4.38	2.4	2.75	1.8
50	60.3	111	1.1	70	0.8
2½	2.875	5.00	4.0	3.00	3.1
65	73.0	127	1.8	76	1.4
76.1	3.000	5.00	4.0	3.00	3.2
	76.1	127	1.8	76	1.5
3	3.500	5.88	5.8	3.38	4.0
80	88.9	149	2.6	86	1.8
4	4.500	7.50	10.3	4.00	7.7
100	114.3	191	4.7	102	3.5
139.7	5.500	9.50	18.1	5.00	10.1
	139.7	241	8.2	127	4.6
5	5.563	9.50	18.1	5.00	10.1
125	141.3	241	8.2	127	4.6
165.1	6.500	10.75	25.3	5.50	18.0
	165.1	273	11.5	140	8.2
6	6.625	10.75	25.3	5.50	18.0
150	168.3	273	11.5	140	8.2
8	8.625	14.25	50.7	7.25	35.3
200	219.1	362	23.0	184	16.0
10	10.750	17.25	73.0	8.50	78.6
250	273.0	438	42.2	216	36.1
12	12.750	20.50	157.6	10.00	73.9
300	323.9	521	71.5	254	33.5
14*	14.000	21.00	149.4	8.75	74.8
350	355.6	533.4	67.9	222.3	34.0

\* Carbon steel fitting with roll groove. Sold as "W" series item.

Models 7110LR / 7111LR

Nominal Size	Pipe O.D.	#7110LR 1.5D LR 90° Elbows		#7111LR 1.5D LR 45° Elbows	
		C - E	Weight	C-LE	Weight
in	in	in	lbs	in	lbs
mm	mm	mm	kg	mm	kg
16*	16.000	24.00	195.8	10.00	98.1
400	406.4	609.6	89.0	254.0	44.6
18*	18.000	27.00	248.6	11.25	124.3
450	457.2	685.8	113.0	285.5	56.5
20*	20.000	30.00	308.0	12.50	154.0
500	508.0	762.0	140.0	317.5	70.0
22*	22.000	33.00	371.8	13.50	187.0
550	558.8	838.2	169.0	342.9	85.0
24*	24.000	36.00	444.4	15.00	222.2
600	609.6	914.4	202.0	381.0	101.0

\* Carbon steel fitting with roll groove. Sold as "W" series item.

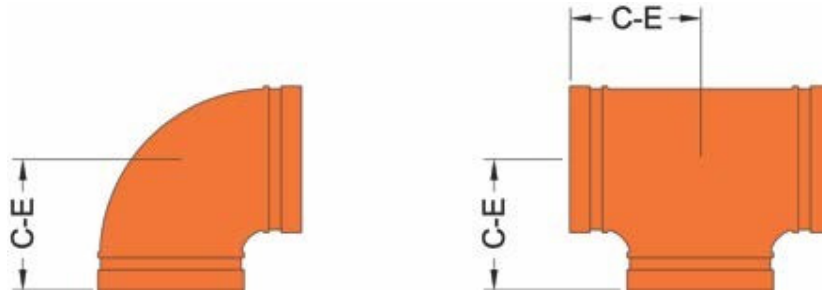

Models 901 / 903

Nominal Pipe Size	Pipe O.D.	901 SR 90° Elbow		903 SR Straight Tee	
		C-E	Weight	C-E	Weight
in	in	in	lbs	in	lbs
mm	mm	mm	kg	mm	kg
2	2.375	2.75	1.5	2.75	2.2
50	60.3	70	0.7	70	1.0
2½	2.875	3.00	2.0	3.00	2.9
65	73.0	76	0.9	76	1.3
76.1	3.000	3.00	2.5	3.00	2.9
	76.1	76	1.1	76	1.3
3	3.500	3.38	3.1	3.38	4.4
80	88.9	86	1.4	86	2.0
4	4.500	4.00	4.9	4.00	7.9
100	114.3	102	2.2	102	3.6
139.7	5.500	4.88	7.9	4.88	11.1
	139.7	124	3.6	124	5.1
5	5.563	4.88	7.9	4.88	10.1
125	141.3	124	3.6	124	4.6
165.1	6.500	5.50	12.9	5.50	16.5
	165.1	140	5.9	140	7.5
6	6.625	5.50	12.9	5.50	17.2
150	168.3	140	5.9	140	7.8
8	8.625	6.94	23.4	6.94	36.3
200	219.1	176	10.6	176	16.5

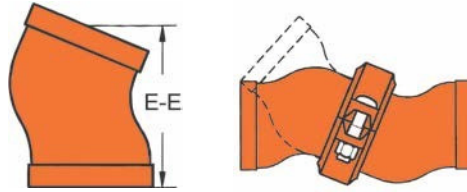

**MODEL 7112G 22.5° ELBOW, Goose Neck Design**

Normal Size	Pipe O.D.	#7112G 22.5° Elbows	
		E-E	weight
in	in	in	lbs
mm	mm	mm	kg
1½	1.900	3.75	1.3
40	48.3	95 G	0.6
2	2.375	3.75	1.3
50	60.3	95 G	0.8
2½	2.875	4.00	2.2
65	73.0	102 G	1.0
76.1	3.000	4.00	2.2
	76.1	102 G	1.0
3	3.500	4.50	3.1
80	88.9	114 G	1.4
4	4.500	5.00	4.4
100	114.3	127 G	2.0
	5.500	5.00	6.5
139.7	139.7	127 G	2.9
5	5.563	5.00	6.8
125	141.3	127 G	3.0
	6.500	6.25	11.0
165.1	165.1	159 G	5.0
6	6.625	6.25	11.0
150	168.3	159 G	5.0
8	8.625	7.75	22.0
200	219.1	197 G	10.0
	8.516	7.75	19.2
200 JIS	216.3	197 G	8.8

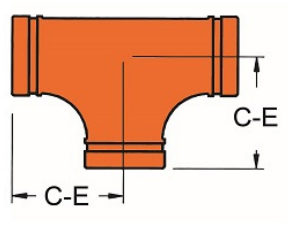

7120 Tee

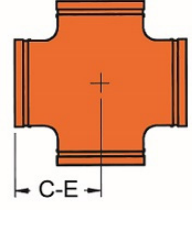

7135 Cross

**Model 7120 TEE / 7135 CROSS**

Nominal Size	Pipe O.D.	#7120 Tee		#7135 Cross	
		C - E	Weight	C-LE	Weight
in	in	in	lbs	in	lbs
mm	mm	mm	kg	mm	kg
1	1.315	2.25	0.9	2.25	---
25	33.4	57	0.4	57	---
1¼	1.660	2.75	1.5	2.75	---
32	42.2	70	0.7	70	---
1½	1.900	2.75	2.0	2.75	---
40	48.3	70	0.9	70	---
2	2.375	3.25	2.9	3.25	2.7
50	60.3	83	1.3	83	1.2
2½	2.875	3.75	4.8	3.75	6.6
65	73.0	95	2.2	95	3.0
76.1	3.000	3.75	5.1	3.75	6.6
	76.1	95	2.3	95	3.0
3	3.500	4.25	6.8	4.25	6.8
80	88.9	108	3.1	108	3.1
4	4.500	5.00	9.9	5.00	11.5
100	114.3	127	4.5	127	5.2
108.0	4.250	5.00	9.0	---	---
	108.0	127	4.1	---	---
133.0	5.250	5.50	13.2	---	---
	133.0	140	6.0	---	---
139.7	5.500	5.50	14.3	5.50	13.0
	139.7	140	6.5	140	5.9
5	5.563	5.50	14.3	5.50	13.0
125	141.3	140	6.5	140	5.9
159.0	6.250	6.50	18.9	---	---
	159.0	165	8.6	---	---

Grooved End Fittings  
Rev.20230217



Model 7120 TEE / 7135 CROSS						
Nominal Size	Pipe O.D.	#7120 Tee		#7135 Cross		
		C - E	Weight	C-LE	Weight	
in	in	in	lbs	in	lbs	
mm	mm	mm	kg	mm	kg	
165.1	6.500	6.50	21.7	6.50	32.0	
	165.1	165	9.9	165	14.5	
6	6.625	6.50	22.0	6.50	32.0	
150	168.3	165	10.0	165	14.5	
8	8.625	7.75	44.0	7.75	44.1	
200	219.1	197	20.0	197	20.0	
10	10.750	9.00	68.2	8.50*	72.7	
250	273.0	229	31.0	216	33.0	
12	12.750	10.00	96.7	10.00*	96.9	
300	323.9	254	43.9	254	44.0	
200 JIS	8.516	7.75	44.0	7.75	44.1	
	216.3	197	20.0	197	20.0	
250 JIS	10.528	9.00	68.2	---	---	
	267.4	229	31.0	---	---	
300 JIS	12.539	10.00	96.7	---	---	
	318.5	254	43.9	---	---	
14*	14.000	11.00	110.2	11.00	121.0	
350	355.6	279.4	50.0	279	54.9	
16*	16.000	12.00	145.4	12.00	146.4	
400	406.4	304.8	66.1	305	66.4	
18*	18.000	13.50	169.8	13.50	185.4	
450	457.2	342.9	77.0	343	84.1	
20*	20.000	15.00	209.4	15.00	229.1	
500	508.0	381.0	95.0	381	103.9	
22*	22.000	16.50	277.2	---	---	
550	558.8	419.1	126.0	---	---	
24*	24.000	17.00	267.9	17.00	298.7	
600	609.6	431.8	121.5	432	135.5	

\* Segmentally welded carbon steel fitting with roll groove. Sold as "W" series item.

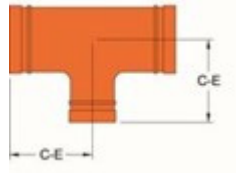

7121 Reducing Tee

Model 7121 Reducing Tee				
Nominal Pipe Size	Pipe O.D.	Main Pipe C-E	Branch C-E	Weight
in	in	in	in	lbs
mm	mm	mm	mm	kg
2 x 2 x 1¼	2.375 x 2.375 x 1.660	3.25	3.25	2.6
50 x 50 x 32	60.3 x 60.3 x 42.2	83	83	1.2
2 x 2 x 1½	2.375 x 2.375 x 1.900	3.25	3.25	2.6
50 x 50 x 40	60.3 x 60.3 x 48.3	83	83	1.2
2½ x 2½ x 1	2.875 x 2.875 x 1.315	3.75	3.75	3.7
65 x 65 x 25	73.0 x 73.0 x 33.4	95	95	1.7
2½ x 2½ x 1¼	2.875 x 2.875 x 1.660	3.75	3.75	3.7
65 x 65 x 32	73.0 x 73.0 x 42.2	95	95	1.7
2½ x 2½ x 1½	2.875 x 2.875 x 1.900	3.75	3.75	4.0
65 x 65 x 40	73.0 x 73.0 x 48.3	95	95	1.8
2½ x 2½ x 2	2.875 x 2.875 x 2.375	3.75	3.75	4.4
65 x 65 x 50	73.0 x 73.0 x 60.3	95	95	2.0
76.1 x 76.1 x 25	3.000 x 3.000 x 1.315	3.75	3.75	3.7
	76.1 x 76.1 x 33.4	95	95	1.7
76.1 x 76.1 x 32	3.000 x 3.000 x 1.660	3.75	3.75	4.4
	76.1 x 76.1 x 42.2	95	95	2.0
76.1 x 76.1 x 40	3.000 x 3.000 x 1.900	3.75	3.75	4.2
	76.1 x 76.1 x 48.3	95	95	1.9
76.1 x 76.1 x 50	3.000 x 3.000 x 2.375	3.75	3.75	4.4
	76.1 x 76.1 x 60.3	95	95	2.0
3 x 3 x 1	3.500 x 3.500 x 1.315	4.25	4.25	5.5
80 x 80 x 25	88.9 x 88.9 x 33.4	108	108	2.5
3 x 3 x 1¼	3.500 x 3.500 x 1.660	4.25	4.25	5.2
80 x 80 x 32	88.9 x 88.9 x 42.2	108	108	2.4
3 x 3 x 1½	3.500 x 3.500 x 1.900	4.25	4.25	5.2
80 x 80 x 40	88.9 x 88.9 x 48.3	108	108	2.4
3 x 3 x 2	3.500 x 3.500 x 2.375	4.25	4.25	6.2
80 x 80 x 50	88.9 x 88.9 x 60.3	108	108	2.8
3 x 3 x 2½	3.500 x 3.500 x 2.875	4.25	4.25	6.2
80 x 80 x 65	88.9 x 88.9 x 73.0	108	108	2.8

Model 7121 Reducing Tee				
Nominal Pipe Size	Pipe O.D.	Main Pipe C-E	Branch C-E	Weight
in	in	in	in	lbs
mm	mm	mm	mm	kg
80 x 80 x 76.1	3.500 x 3.500 x 3.000	4.25	4.25	6.2
	88.9 x 88.9 x 76.1	108	108	2.8
4 x 4 x 1	4.500 x 4.500 x 1.315	5.00	5.00	8.9
100 x 100 x 25	114.3 x 114.3 x 33.4	127	127	4.0
4 x 4 x 1½	4.500 x 4.500 x 1.900	5.00	5.00	9.3
100 x 100 x 40	114.3 x 114.3 x 48.3	127	127	4.2
4 x 4 x 2	4.500 x 4.500 x 2.375	5.00	5.00	8.8
100 x 100 x 50	114.3 x 114.3 x 60.3	127	127	4.0
4 x 4 x 2½	4.500 x 4.500 x 2.875	5.00	5.00	9.5
100 x 100 x 65	114.3 x 114.3 x 73.0	127	127	4.3
100 x 100 x 76.1	4.500 x 4.500 x 3.000	5.00	5.00	9.5
	114.3 x 114.3 x 76.1	127	127	4.3
4 x 4 x 3	4.500 x 4.500 x 3.500	5.00	5.00	9.4
100 x 100 x 80	114.3 x 114.3 x 88.9	127	127	4.3
139.7 x 139.7 x 50	5.500 x 5.500 x 2.375	5.50	5.50	12.4
	139.7 x 139.7 x 60.3	140	140	5.6
139.7 x 139.7 x 65	5.500 x 5.500 x 2.875	5.50	5.50	12.8
	139.7 x 139.7 x 73.0	140	140	5.8
5 x 5 x 2	5.563 x 5.563 x 2.375	5.50	5.50	12.4
125 x 125 x 50	141.3 x 141.3 x 60.3	140	140	5.6
5 x 5 x 2½	5.563 x 5.563 x 2.875	5.50	5.50	12.8
125 x 125 x 65	141.3 x 141.3 x 73.0	140	140	5.8
5 x 5 x 3	5.563 x 5.563 x 3.500	5.50	5.50	12.6
125 x 125 x 80	141.3 x 141.3 x 88.9	140	140	5.7
5 x 5 x 4	5.563 x 5.563 x 4.500	5.50	5.50	13.6
125 x 125 x 100	141.3 x 141.3 x 114.3	140	140	6.2
165.1 x 165.1 x 50	6.500 x 6.500 x 2.375	6.50	6.50	17.6
	165.1 x 165.1 x 60.3	165	165	8.0
165.1 x 165.1 x 76.1	6.500 x 6.500 x 3.000	6.50	6.50	18.7
	165.1 x 165.1 x 76.1	165	165	8.5
165.1 x 165.1 x 80	6.500 x 6.500 x 3.500	6.50	6.50	20.2
	165.1 x 165.1 x 88.9	165	165	9.2
165.1 x 165.1 x 100	6.500 x 6.500 x 4.500	6.50	6.50	19.4
	165.1 x 165.1 x 114.3	165	165	8.8
6 x 6 x 2	6.625 x 6.625 x 2.375	6.50	6.50	17.6
150 x 150 x 50	168.3 x 168.3 x 60.3	165	165	8.0
6 x 6 x 2½	6.625 x 6.625 x 2.875	6.50	6.50	18.7
150 x 150 x 65	168.3 x 168.3 x 73.0	165	165	8.5
6 x 6 x 3	6.625 x 6.625 x 3.500	6.50	6.50	20.2
150 x 150 x 80	168.3 x 168.3 x 88.9	165	165	9.2

Model 7121 Reducing Tee				
Nominal Pipe Size	Pipe O.D.	Main Pipe C-E	Branch C-E	Weight
in	in	in	in	lbs
mm	mm	mm	mm	kg
6 x 6 x 4	6.625 x 6.625 x 4.500	6.50	6.50	19.4
150 x 150 x 100	168.3 x 168.3 x 114.3	165	165	8.8
8 x 8 x 2	8.625 x 8.625 x 2.375	7.75	7.75	32.5
200 x 200 x 50	219.1 x 219.1 x 60.3	197	197	14.8
8 x 8 x 2½	8.625 x 8.625 x 2.875	7.75	7.75	31.9
200 x 200 x 65	219.1 x 219.1 x 73.0	197	197	14.5
8 x 8 x 3	8.625 x 8.625 x 3.500	7.75	7.75	34.2
200 x 200 x 80	219.1 x 219.1 x 88.9	197	197	15.5
8 x 8 x 4	8.625 x 8.625 x 4.500	7.75	7.75	44.0
200 x 200 x 100	219.1 x 219.1 x 114.3	197	197	20.0
8 x 8 x 5**	8.625 x 8.625 x 5.563	7.00	6.38	39.2
200 x 200 x 125	219.1 x 219.1 x 141.3	178	162	17.8
200 x 200 x 139.7**	8.625 x 8.625 x 5.500	7.00	6.38	42.7
	219.1 x 219.1 x 139.7	178	162	19.4
8 x 8 x 6	8.625 x 8.625 x 6.625	7.75	7.75	46.2
200 x 200 x 150	219.1 x 219.1 x 168.3	197	197	21.0
10 x 10 x 4	10.750 x 10.750 x 4.500	9.00	9.00	62.8
250 x 250 x 100	273.0 x 273.0 x 114.3	229	229	28.5
250 x 250 x 139.7*	10.750 x 10.750 x 5.500	9.00	9.00	64.4
	273.0 x 273.0 x 139.7	229	229	29.3
10 x 10 x 6	10.750 x 10.750 x 6.625	9.00	9.00	66.0
250 x 250 x 150	273.0 x 273.0 x 168.3	229	229	30.0
10 x 10 x 8	10.750 x 10.750 x 8.625	9.00	9.00	69.3
250 x 250 x 200	273.0 x 273.0 x 219.1	229	229	31.5
12 x 12 x 3	12.750 x 12.750 x 3.500	10.00	10.00	88.1
300 x 300 x 80	323.9 x 323.9 x 88.9	254	254	40.0
12 x 12 x 4	12.750 x 12.750 x 4.500	10.00	10.00	90.4
300 x 300 x 100	323.9 x 323.9 x 114.3	254	254	41.0
12 x 12 x 6	12.750 x 12.750 x 6.625	10.00	10.00	83.6
300 x 300 x 150	323.9 x 323.9 x 168.3	254	254	38.0
12 x 12 x 8	12.750 x 12.750 x 8.625	10.00	10.00	83.6
300 x 300 x 200	323.9 x 323.9 x 219.1	254	254	38.0
14 x 2½*	14.000 x 2.875	11.0	9.37	--
350 x 65	355.6 x 73.0	279.0	238.0	--
14 x 3*	14.000 x 3.500	11.0	9.37	--
350 x 80	355.6 x 88.9	279.0	238.0	--
14 x 4*	14.000 x 4.5	11.0	9.37	--
350 x 100	355.6 x 114.3	279.0	238.0	--
14 x 6*	14.000 x 6.625	11.0	9.37	101.2
350 x 150	355.6 x 168.3	279.0	238.0	46.0

Model 7121 Reducing Tee				
Nominal Pipe Size	Pipe O.D.	Main Pipe C-E	Branch C-E	Weight
in	in	in	in	lbs
mm	mm	mm	mm	kg
14 x 8*	14.000 x 8.625	11.0	9.76	102.3
350 x 200	355.6 x 219.1	279.0	248.0	46.5

\* Segmentally welded carbon steel fitting with roll groove. Sold as "W" series item.

\*\* Fabricated

Model 7121 Reducing Tee				
Nominal Pipe Size	Pipe O.D.	Main Pipe C-E	Branch C-E	Weight
In	in	in	in	lbs
Mm	mm	mm	mm	kg
14 x 10*	14.000 x 10.750	11.0	10.12	104.9
350 x 250	355.6 x 273.0	279.0	257.0	47.7
14 x 12*	14.000 x 12.750	11.0	10.63	96.8
350 x 300	355.6 x 323.9	279.0	270.0	44.0
16 x 6*	16.000 x 6.625	12.0	10.40	125.8
400 x 150	406.4 x 168.3	305.0	264.0	57.2
16 x 8*	16.000 x 8.625	12.0	10.75	127.2
400 x 200	406.4 x 219.1	305.0	273.0	57.8
16 x 10*	16.000 x 10.750	12.0	11.14	129.6
400 x 250	406.4 x 273.0	305.0	283.0	58.9
16 x 12*	16.000 x 12.750	12.0	11.61	132.2
400 x 300	406.4 x 323.9	305.0	295.0	60.1
16 x 14*	16.000 x 14.000	12.0	12.00	134.4
400 x 350	406.4 x 355.6	305.0	305.0	61.1
18 x 6*	18.000 x 6.625	13.5	11.38	159.7
450 x 150	457.2 x 168.3	343.0	289.0	72.6
18 x 8*	18.000 x 8.625	13.5	11.75	160.6
450 x 200	457.2 x 219.1	343.0	298.0	73.0
18 x 10*	18.000 x 10.750	13.5	12.13	162.8
450 x 250	457.2 x 273.0	343.0	308.0	74.0
18 x 12*	18.000 x 12.750	13.5	12.64	165.2
450 x 300	457.2 x 323.9	343.0	321.0	75.1
18 x 14*	18.000 x 14.000	13.5	13.00	167.2
450 x 350	457.2 x 355.6	343.0	330.0	76.0
18 x 16*	18.000 x 16.000	13.5	13.00	167.9
450 x 400	457.2 x 406.4	343.0	330.0	76.3
20 x 6*	20.000 x 6.625	15.0	12.36	196.9
500 x 150	508.0 x 168.3	381.0	314.0	89.5
20 x 8*	20.000 x 8.625	15.0	12.76	198.0
500 x 200	508.0 x 219.1	381.0	324.0	90.0
20 x 10*	18.000 x 10.750	15.0	13.11	200.0
500 x 250	508.0 x 273.0	381.0	333.0	90.9
20 x 12*	20.000 x 12.750	15.0	13.62	202.4
500 x 300	508.0 x 323.9	381.0	346.0	92.0
20 x 14*	20.000 x 14.000	15.0	14.02	204.4
500 x 350	508.0 x 355.6	381.0	356.0	92.9

\* Segmentally welded carbon steel fitting with roll groove. Sold as "W" series item.

Model 7121 Reducing Tee					
Nominal Pipe Size		Pipe O.D.	Main Pipe C-E	Branch C-E	Weight
in		in	in	in	lbs
mm		mm	mm	mm	kg
20 x 16*		20.000 x 16.000	15.0	14.02	204.6
500 x 400		508.0 x 406.4	381.0	356.0	93.6
20 x 18*		20.000 x 18.000	15.0	14.50	207.9
500 x 450		508.0 x 457.2	381.0	368.0	94.5
24 x 6*		24.000 x 6.625	17.0	14.38	268.4
600 x 150		609.6 x 168.3	432.0	365.0	122.0
24 x 8*		24.000 x 8.625	17.0	14.76	270.6
600 x 200		609.6 x 219.1	432.0	375.0	123.0
24 x 10*		24.000 x 10.750	17.0	15.12	271.0
600 x 250		609.6 x 273.0	432.0	384.0	123.2
24 x 12*		24.000 x 12.750	17.0	15.63	273.2
600 x 300		609.6 x 323.9	432.0	397.0	124.2
24 x 14*		24.000x14.000	17.0	16.00	275.0
600 x 350		609.6 x 355.6	432.0	406.0	125.0
24 x 16*		24.000 x 16.000	17.0	16.00	275.0
600 x 400		609.6 x 406.4	432.0	406.0	125.0
24 x 18*		24.000x18.000	17.0	16.50	279.6
600 x 450		609.6 x 457.2	432.0	419.0	127.1
24 x 20*		24.000 x 20.000	17.0	17.00	281.6
600 x 500		609.6 x 508.0	432.0	432.0	128.0

\* Segmentally welded carbon steel fitting with roll groove. Sold as "W" series item.

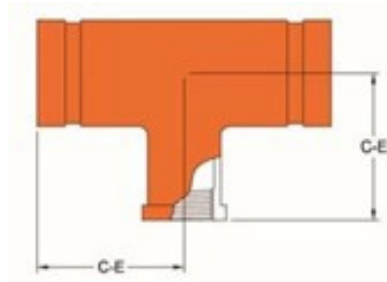

7121F Reducing Tee (Female Threaded)

**Model 7121F Reducing Tee**

Nominal Pipe Size	Pipe O.D.	Female Threaded Branch		Nominal Pipe Size	Pipe OD	Female Threaded Branch	
		C-E	Weight			C-E	Weight
in	in	in	lbs	in	in	in	lbs
mm	mm	mm	kg	mm	mm	mm	Kg
2 x 2 x 1¼	2.375 x 2.375 x 1.660	3.25	2.9	3 x 3 x 1¼	3.500 x 3.500 x 1.660	4.25	5.1
50 x 50 x 32	60.3 x 60.3 x 42.2	83	1.3	80 x 80 x 32	88.9 x 88.9 x 42.2	108	2.3
2 x 2 x 1½	2.375 x 2.375 x 1.900	3.25	4.0	3 x 3 x 1½	3.500 x 3.500 x 1.900	4.25	6.0
50 x 50 x 40	60.3 x 60.3 x 48.3	83	1.8	80 x 80 x 40	88.9 x 88.9 x 48.3	108	2.7
2½ x 2½ x 1	2.875 x 2.875 x 1.315	3.75	4.0	3 x 3 x 2	3.500 x 3.500 x 2.375	4.25	6.2
65 x 65 x 25	73.0 x 73.0 x 33.4	95	1.8	80 x 80 x 50	88.9 x 88.9 x 60.3	108	2.8
2½ x 2½ x 1¼	2.875 x 2.875 x 1.660	3.75	3.7	3 x 3 x 2½	3.500 x 3.500 x 2.875	4.25	7.3
65 x 65 x 32	73.0 x 73.0 x 42.2	95	1.7	80 x 80 x 65	88.9 x 88.9 x 73.0	108	3.3
2½ x 2½ x 1½	2.875 x 2.875 x 1.900	3.75	4.4	4 x 4 x 1½	4.500 x 4.500 x 1.900	5.00	9.3
65 x 65 x 40	73.0 x 73.0 x 48.3	95	2.0	100 x 100 x 40	114.3 x 114.3 x 48.3	127	4.2
2½ x 2½ x 2	2.875 x 2.875 x 2.375	3.75	4.6	4 x 4 x 2	4.500 x 4.500 x 2.375	5.00	9.3
65 x 65 x 50	73.0 x 73.0 x 60.3	95	2.1	100 x 100 x 50	114.3 x 114.3 x 60.3	127	4.2
76.1 x 76.1 x 25	3.000 x 3.000 x 1.315	3.75	4.4	4 x 4 x 2½	4.500 x 4.500 x 2.875	5.00	10.8
	76.1 x 76.1 x 33.4	95	2.0	100 x 100 x 65	114.3 x 114.3 x 73.0	127	4.9
76.1 x 76.1 x 32	3.000 x 3.000 x 1.660	3.75	4.4	100 x 100 x 76.1	4.500 x 4.500 x 3.000	5.00	9.9
	76.1 x 76.1 x 42.2	95	2.0		114.3 x 114.3 x 76.1	127	4.5
76.1 x 76.1 x 40	3.000 x 3.000 x 1.900	3.75	4.0	139.7 x 139.7 x 50	5.500 x 5.500 x 2.375	5.50	11.9
	76.1 x 76.1 x 48.3	95	1.8		139.7 x 139.7 x 60.3	140	5.4
76.1 x 76.1 x 50	3.000 x 3.000 x 2.375	3.75	4.9	5 x 5 x 2	5.563 x 5.563 x 2.375	5.50	12.3
	76.1 x 76.1 x 60.3	95	2.2	125 x 125 x 50	141.3 x 141.3 x 60.3	140	5.6
3 x 3 x ½	3.500 x 3.500 x 0.840	4.25	5.1	165.1 x 165.1 x 50	6.500 x 6.500 x 2.375	6.50	17.6
80 x 80 x 15	88.9 x 88.9 x 21.3	108	2.3		165.1 x 165.1 x 60.3	165	8.0
3 x 3 x ¾	3.500 x 3.500 x 1.050	4.25	5.1	6 x 6 x 2	6.625 x 6.625 x 2.375	6.50	20.5
80 x 80 x 20	88.9 x 88.9 x 26.7	108	2.3	150 x 150 x 50	168.3 x 168.3 x 60.3	165	9.3
3 x 3 x 1	3.500 x 3.500 x 1.315	4.25	5.1	6 x 6 x 2½	6.625 x 6.625 x 2.875	6.50	15.7
80 x 80 x 25	88.9 x 88.9 x 33.4	108	2.3	150 x 150 x 65	168.3 x 168.3 x 73.0	165	7.1

Grooved End Fittings  
Rev.20230217



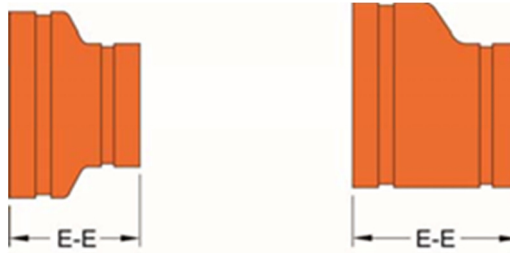

7150 Concentric Reducer

7151 Eccentric Reducer

Model 7150 Concentric Reducer / 7151 Eccentric Reducer

Nominal Size	Pipe O.D.	7150 Concentric Reducer		7151 Eccentric Reducer	
		E-E	Weight	E-E	Weight
		in	lbs	in	lbs
mm	mm	mm	kg	mm	kg
1¼ x 1	1.660 x 1.315	2.50	0.4	---	---
32 x 25	42.2 x 33.4	64	0.2	---	---
1½ x 1	1.900 x 1.315	2.50	0.5	---	---
40 x 25	48.3 x 33.4	64	0.2	---	---
1½ x 1¼	1.900 x 1.660	2.50	0.6	---	---
40 x 32	48.3 x 42.2	64	0.3	---	---
2 x 1	2.375 x 1.315	2.50	0.9	3.00*	0.9
50 x 25	60.3 x 33.4	64	0.4	76	0.4
2 x 1¼	2.375 x 1.660	2.50	0.7	---	---
50 x 32	60.3 x 42.2	64	0.3	---	---
2 x 1½	2.375 x 1.900	2.50	0.8	3.00*	0.9
50 x 40	60.3 x 48.3	64	0.4	76	0.4
2½ x 2	2.875 x 2.375	2.50	1.1	3.50	1.4
65 x 50	73.0 x 60.3	64	0.5	89	0.7
76.1 x 50	3.000 x 2.375	2.50	1.1	3.50	1.6
	76.1 x 60.3	64	0.5	89	0.7
3 x 1	3.500 x 1.315	2.50	1.3	3.50*	2.0
80 x 25	88.9 x 33.4	64	0.6	89	0.9
3 x 1¼	3.500 x 1.660	2.50	1.3	3.50*	2.6
80 x 32	88.9 x 42.2	64	0.6	89	1.2
3 x 1½	3.500 x 1.900	2.50	1.3	3.50*	2.6
80 x 40	88.9 x 48.3	64	0.6	89	1.2
3 x 2	3.500 x 2.375	2.50	1.3	3.50	2.2
80 x 50	88.9 x 60.3	64	0.6	89	1.0
3 x 2½	3.500 x 2.875	2.50	1.3	3.50	2.2
80 x 65	88.9 x 73.0	64	0.6	89	1.0
80 x 76.1	3.500 x 3.000	2.50	1.3	3.50	2.2
	88.9 x 76.1	64	0.6	89	1.0
4 x 2	4.500 x 2.375	3.00	2.0	4.00	2.8
100 x 50	114.3 x 60.3	76	0.9	102	1.3

Grooved End Fittings  
Rev. 20230217

Model 7150 Concentric Reducer / 7151 Eccentric Reducer

Nominal Size	Pipe O.D.	7150 Concentric Reducer		7151 Eccentric Reducer	
		E-E	Weight	E-E	Weight
		in	lbs	in	lbs
mm	mm	mm	kg	mm	kg
4 x 2½	4.500 x 2.875	3.00	2.2	4.00	3.3
100 x 65	114.3 x 73.0	76	1.0	102	1.5
100 x 76.1	4.500 x 3.000	3.00	2.3	4.00	3.3
	114.3 x 76.1	76	1.0	102	1.5
4 x 3	4.500 x 3.500	3.00	2.2	4.00	2.9
100 x 80	114.3 x 88.9	76	1.0	102	1.3
5 x 4	5.563 x 4.500	3.50	3.6	4.00	6.2
125 x 100	141.3 x 114.3	89	1.6	102	2.8
6 x 2	6.625 x 2.375	4.00	4.2	4.00	4.4
150 x 50	168.3 x 60.3	102	1.9	102	2.0
6 x 2½	6.625 x 2.875	4.00	4.4	5.50*	6.6
150 x 65	168.3 x 73.0	102	2.0	140	3.0
6 x 3	6.625 x 3.500	4.00	4.4	4.00	7.8
150 x 80	168.3 x 88.9	102	2.0	102	3.5
6 x 4	6.625 x 4.500	4.00	4.6	4.00	5.8
150 x 100	168.3 x 114.3	102	2.1	102	2.7
6 x 5	6.625 x 5.563	4.00	5.5	4.00	9.9
150 x 125	168.3 x 141.3	102	2.5	102	4.5
165.1 x 50	6.500 x 2.375	4.00	4.2	4.00	4.4
	165.1 x 60.3	102	1.9	102	2.0
165.1 x 76.1	6.500 x 3.000	4.00	4.2	5.50*	6.6
	165.1 x 76.1	102	1.9	140	3.0
165.1 x 80	6.500 x 3.500	4.00	4.4	4.00	7.7
	165.1 x 88.9	102	2.0	102	3.5
165.1 x 100	6.500 x 4.500	4.00	4.6	4.00	5.8
	165.1 x 114.3	102	2.1	102	2.7
165.1 x 139.7	6.500 x 5.500	4.00	5.5	4.00	9.9
	165.1 x 139.7	102	2.5	102	4.5
8 x 3	8.625 x 3.500	5.00	9.5	---	---
200 x 80	219.1 x 88.9	127	4.3	---	---
8 x 4	8.625 x 4.500	5.00	11.2	5.00	14.6
200 x 100	219.1 x 114.3	127	5.1	127	6.6
8 x 6	8.625 x 6.625	5.00	11.4	5.00	12.0
200 x 150	219.1 x 168.3	127	5.2	127	5.5
10 x 4	10.750 x 4.500	6.00	19.8	6.00	26.4
250 x 100	273.0 x 114.3	152	9.0	152	12.0

\* fabricated item

G...\_jd Enc...195 Rev.20230217

Model 7150 Concentric Reducer / 7151 Eccentric Reducer

Nominal Size	Pipe O.D.	7150 Concentric Reducer		7151 Eccentric Reducer	
		E-E	Weight	E-E	Weight
		in	lbs	in	lbs
mm	mm	mm	kg	mm	kg
10 x 6	10.750 x 6.625	6.00	19.8	6.00	25.3
250 x 150	273.0 x 168.3	152	9.0	152	11.5
10 x 8	10.750 x 8.625	6.00	20.9	7.00	26.8
250 x 200	273.0 x 219.1	152	9.5	178	12.2
12 x 6	12.750 x 6.625	7.00	30.9	7.00	39.7
300x150	323.9 x 168.3	178	14.0	178	18.0
12 x 8	12.750 x 8.625	7.00	30.9	7.00	40.8
300 x 200	323.9 x 219.1	178	14.0	178	18.5
12 x 10	12.750 x 10.750	7.00	30.1	7.00	44.1
300 x 250	323.9 x 273.0	178	13.7	178	20.0
14 x 6*	14.000 x 6.625	13.00	67.76	13.00	67.76
350 x 150	355.6 x 168.3	330.0	30.8	330.0	30.8
14 x 8*	14.000 x 8.625	13.00	69.96	13.00	69.96
350 x 200	355.6 x 219.1	330.0	31.8	330.0	31.8
14 x 10*	14.000 x 10.750	13.00	71.94	13.00	71.94
350 x 250	355.6 x 273.0	330.0	32.7	330.0	32.7
14 x 12*	14.000 x 12.750	13.00	73.92	13.00	73.92
350 x 300	355.6 x 323.9	330.0	33.6	330.0	33.6
16 x 8*	16.000 x 8.625	14.00	87.78	14.00	87.78
400 x 200	406.4 x 219.1	356.0	39.9	356.0	39.9
16 x 10*	16.000 x 10.750	14.00	90.86	14.00	90.86
400 x 250	406.4 x 273.0	356.0	41.3	356.0	41.3
16 x 12*	16.000 x 12.750	14.00	92.84	14.00	92.84
400 x 300	406.4 x 323.9	356.0	42.2	356.0	42.2
16 x 14*	16.000 x 14.000	14.00	94.82	14.00	94.82
400 x 350	406.4 x 355.6	356.0	43.1	356.0	43.1
18 x 10*	18.000 x 10.750	15.00	111.76	15.00	111.76
450 x 250	457.2 x 273.0	381.0	50.8	381.0	50.8
18 x 12*	18.000 x 12.750	15.00	114.84	15.00	114.84
450 x 300	457.2 x 323.9	381.0	52.2	381.0	52.2
18 x 14*	18.000 x 14.000	15.00	117.70	15.00	117.70
450 x 350	457.2 x 355.6	381.0	53.5	381.0	53.5

\* Segmentally welded carbon steel fitting with roll groove. Sold as "W" series item.

Model 7150 Concentric Reducer / 7151 Eccentric Reducer

Nominal Size	Pipe O.D.	7150 Concentric Reducer		7151 Eccentric Reducer	
		E-E	Weight	E-E	Weight
		in	lbs	in	lbs
mm	mm	mm	kg	mm	kg
18 x 16*	18.000 x 16.000	15.00	120.78	15.00	120.78
450 x 400	457.2 x 406.4	381.0	54.9	381.0	54.9
20 x 12*	20.000 x 12.750	20.00	159.72	20.00	159.72
500 x 300	508.0 x 323.9	508.0	72.6	508.0	72.6
20 x 14*	20.000 x 14.000	20.00	163.68	20.00	163.68
500 x 350	508.0 x 355.6	508.0	74.4	508.0	74.4
20 x 16*	20.000 x 16.000	20.00	167.64	20.00	167.64
500 x 400	508.0 x 406.4	508.0	76.2	508.0	76.2
20 x 18*	20.000 x 18.000	20.00	171.60	20.00	171.6
500 x 450	508.0 x 457.2	508.0	78.0	508.0	78.0
24 x 16*	24.000 x 16.000	20.00	197.56	20.00	197.56
600 x 400	609.6 x 406.4	508.0	89.8	508.0	89.8
24 x 18*	24.000 x 18.000	20.00	199.54	20.00	199.54
600 x 450	609.6 x 457.2	508.0	90.7	508.0	90.7
24 x 20*	24.000 x 20.000	20.00	203.50	20.00	203.50
600 x 500	609.6 x 508.0	508.0	92.5	508.0	92.5

\* Segmentally welded carbon steel fitting with roll groove. Sold as "W" series item.

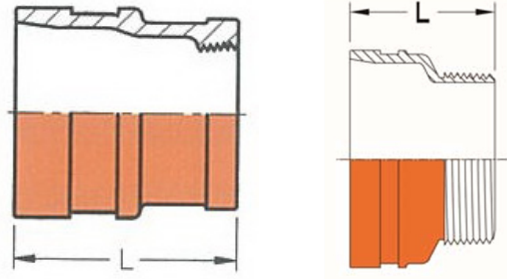

Model 7150F Reducing Socket, 7150M Reducing Nipple

Nom. Size Gr. X Th.	Pipe O.D.	7150F		7150M		Nom. Size Gr. X Th.	Pipe O.D.	7150F		7150M	
		L	Weight	L	Weight			L	Weight	L	Weight
in	in	in	lbs	in	lbs	in	in	in	lbs	in	lbs
mm	mm	mm	kg	mm	kg	mm	mm	mm	kg	mm	kg
1½ x 1	1.900 x 1.315	2.5	0.60	2.5	0.53	80 x 76.1	3.500 x 3.000	2.5	2.20	2.5	2.20
40 x 25	48.3 x 33.4	63.5	0.27	63.5	0.24		88.9 x 76.1	63.5	1.00	63.5	1.00
2 x 1	2.375 x 1.315	2.5	0.92	2.5	0.88	4 x 1¼	4.500 x 1.660	3.0	2.33	3.0	2.19
50 x 25	60.3 x 33.4	63.5	0.42	63.5	0.40	100 x 32	114.3 x 42.2	76.1	1.06	76.1	0.99
2 x 1¼	2.375 x 1.660	2.5	1.01	2.5	0.70	4 x 1½	4.500 x 1.900	3.0	2.05	3.0	2.05
50 x 32	60.3 x 42.2	63.5	0.46	63.5	0.32	100 x 40	114.3 x 48.3	76.1	0.93	76.1	0.93

Model 7150F Reducing Socket, 7150M Reducing Nipple

Nom. Size Gr. X Th.	Pipe O.D.	7150F		7150M		Nom. Size Gr. X Th.	Pipe O.D.	7150F		7150M	
		L	Weight	L	Weight			L	Weight	L	Weight
		in	lbs	in	lbs			in	lbs	in	lbs
mm	mm	mm	Kg	mm	kg	mm	mm	mm	kg	mm	kg
2 x 1½	2.375 x 1.900	2.5	0.95	2.5	1.04	4 x 2	4.500 x 2.375	3.0	2.29	3.0	2.31
50 x 40	60.3 x 48.3	63.5	0.43	63.5	0.47	100 x 50	114.3 x 60.3	76.1	1.03	76.1	1.05
2½ x 1	2.875 x 1.315	2.5	1.21	2.5	0.88	4 x 2½	4.500 x 2.875	3.0	2.25	3.0	2.05
65 x 25	73.0 x 33.4	63.5	0.55	63.5	0.40	100 x 65	114.3 x 73.0	76.1	1.02	76.1	0.93
25 x 76.1	3.000 x 1.315	2.5	1.21	2.5	1.64	4 x 2½	4.500 x 3.000	3.0	2.25	3.0	2.05
	76.1 x 33.4	63.5	0.55	63.5	0.75	100 x 65	114.3 x 76.1	76.1	1.02	76.1	0.93
2½ x 1¼	2.875 x 1.660	2.5	1.17	2.5	1.59	5 x 1½	5.563 x 1.900	3.5	3.94	3.5	2.05
65 x 32	73.0 x 42.2	63.5	0.53	63.5	0.72	125 x 40	141.3 x 48.3	88.9	1.79	88.9	0.93
32 x 76.1	3.000 x 1.660	2.5	1.17	2.5	1.59	40 x 139.7	5.500 x 1.900	3.5	3.94	3.5	2.05
	76.1 x 42.2	63.5	0.53	63.5	0.72		139.7 x 48.3	88.9	1.79	88.9	0.93
2½ x 1½	2.875 x 1.900	2.5	1.08	2.5	1.72	6 x 1½	6.625 x 1.900	4.0	6.47	4.0	4.84
65 x 40	73.0 x 48.3	63.5	0.49	63.5	0.78	150 x 40	168.3 x 48.3	101.6	2.94	101.6	2.20
40 x 76.1	3.000 x 1.900	2.5	1.08	2.5	1.72	40 x 165.1	6.500 x 1.900	4.0	5.56	4.0	4.75
	76.1 x 48.3	63.5	0.49	63.5	0.78		165.1 x 48.3	101.6	2.52	101.6	2.15
2½ x 2	2.875 x 2.375	2.5	1.52	2.5	0.92	6 x 2	6.625 x 2.375	4.0	5.28	4.0	4.91
65 x 50	73.0 x 60.3	63.5	0.69	63.5	0.42	150 x 50	168.3 x 60.3	101.6	2.40	101.6	2.23
50 x 76.1	3.000 x 2.375	2.5	1.52	2.5	1.09	50 x 165.1	6.500 x 2.375	4.0	5.28	4.0	4.91
	76.1 x 60.3	63.5	0.69	63.5	0.49		165.1 x 60.3	101.6	2.40	101.6	2.23
3 x 1	3.500 x 1.315	2.5	1.91	2.5	1.25	6 x 2½	6.625 x 2.875	4.0	5.46	4.0	4.91
80 x 25	88.9 x 33.4	63.5	0.87	63.5	0.57	150 x 65	168.3 x 73.0	101.6	2.48	101.6	2.23
3 x 1¼	3.500 x 1.660	2.5	1.50	2.5	1.67	65 x 165.1	6.500 x 3.000	4.0	4.40	4.0	4.97
80 x 32	88.9 x 42.2	63.5	0.68	63.5	0.76		165.1 x 76.1	101.6	2.00	101.6	2.26
3 x 1½	3.500 x 1.900	2.5	1.63	2.5	1.53	6 x 4	6.625 x 4.500	4.0	6.37	4.0	4.52
80 x 40	88.9 x 48.3	63.5	0.74	63.5	0.74	150 x 100	168.3 x 114.3	101.6	2.89	101.6	2.10
3 x 2	3.500 x 2.375	2.5	1.56	2.5	1.32	100 x 165.1	6.500 x 4.500	4.0	4.52	4.0	4.52
80 x 50	88.9 x 60.3	63.5	0.71	63.5	0.60		165.1 x 114.3	101.6	2.10	101.6	2.10
3 x 2½	3.500 x 2.875	2.5	2.20	2.5	2.20						
80 x 65	88.9 x 73.0	63.5	1.00	63.5	1.00						

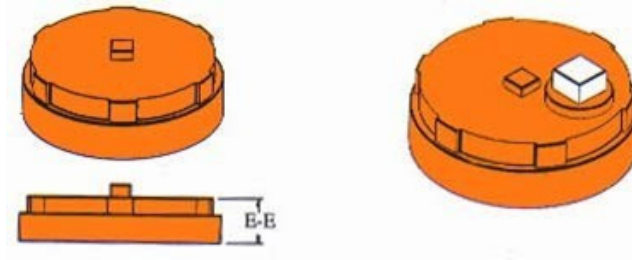

1"-12"

Models 7160 End Cap / 7160P End Cap with Plug

Nominal Pipe Size	Pipe O.D.	7160 End Cap		7160P Plug Size
		E-E	weight	
in	in	in	lbs	in
mm	mm	mm	kgs	mm
1	1.315	0.87	0.2	---
25	33.4	22	0.1	---
1¼	1.660	1.00	0.3	---
32	42.2	25	0.2	---
1½	1.900	1.00	0.4	---
40	48.3	25	0.2	---
2	2.375	1.00	0.7	½
50	60.3	25	0.3	15
2½	2.875	1.00	0.9	½
65	73.0	25	0.4	15
76.1	3.000	1.00	0.9	½
	76.1	25	0.4	15
3	3.500	1.00	1.5	½
80	88.9	25	0.7	15
108.0	4.250	1.00	2.4	---
	108.0	25	1.1	---
4	4.500	1.00	2.2	1
100	114.3	25	1.0	25
133.0	5.250	1.00	3.7	---
	133.0	25	1.7	---
139.7	5.500	1.00	3.7	1
	139.7	25	1.7	25
5	5.563	1.00	3.7	1
125	141.3	25	1.7	25
159.0	6.250	1.00	5.1	---
	159.0	25	2.3	---
165.1	6.500	1.00	6.0	1
	165.1	25	2.7	25

Grooved End Fittings  
Rev.20230217

Models 7160 End Cap / 7160P End Cap with Plug

Nominal Pipe Size	Pipe O.D.	7160 End Cap		7160P Plug Size
		E-E	weight	
in	in	in	lbs	in
mm	mm	mm	kgs	mm
6	6.625	1.00	6.0	1
150	168.3	25	2.7	25
8	8.625	1.18	10.1	1½
200	219.1	30	4.6	40
10	10.750	1.25	15.4	1½
250	273.0	32	7.0	40
12	12.750	1.25	22.0	1½
300	323.9	32	10.0	40
200 JIS	8.516	1.18	10.1	---
	216.3	30	4.6	---
250 JIS	10.528	1.25	15.4	---
	267.4	32	7.0	---
300 JIS	12.539	1.25	22.0	---
	318.5	32	10.0	---
14*	14.000	6.50	35.0	---
350	355.6	165.0	15.9	---
16*	16.000	7.00	44.0	---
400	406.4	178.0	20.0	---
18*	18.000	8.00	56.1	---
450	457.2	203.0	25.5	---
20*	20.000	9.00	70.0	---
500	508.0	229.0	31.8	---
22*	22.000	10.00	85.4	---
550	558.8	254.0	38.8	---
24*	24.000	10.50	99.2	---
600	609.6	267.0	45.1	---

\* Segmentally welded carbon steel fitting with roll groove. Sold as "W" series item.



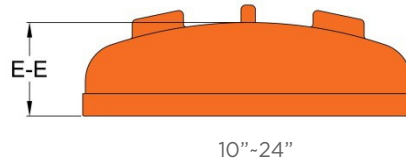

Model 7160H Domed End Cap

Nominal Pipe Size	Pipe O.D.	#7160H Domed End Cap	
		E-E	weight
in	in	in	Lbs
mm	mm	mm	kgs
10	10.750	3.00	12.1
250	273.0	76.1	5.5
12	12.750	3.00	16.3
300	323.9	76.1	7.4
14	14.000	4.00	26.4
350	355.6	102.0	12.0
16	16.000	4.00	32.0
400	406.4	102.0	14.5
18	18.000	5.00	39.2
450	457.2	127.0	17.8
20	20.000	6.00	53.9
500	508.0	152.0	24.5
24	24.000	6.00	75.9
600	609.6	152.0	34.5
28	28.000	10.50	125.1
700	711.2	266.6	56.8

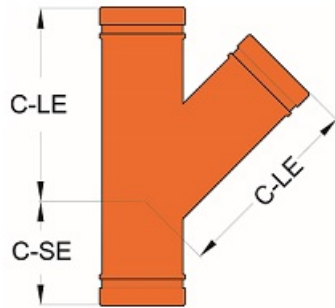

7130 45° Lateral

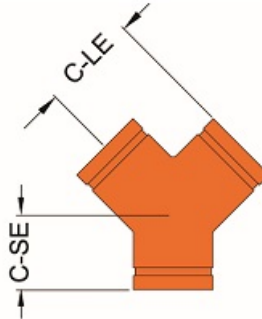

7137 True-Y

Models 7130 / 7137

Nominal Size	Pipe O.D.	#7130 45° Lateral			#7137 True-Y		
		C - LE	C-SE	Weight	C-LE	C-SE	Weight
in	in	in	in	lbs	in	in	lbs
mm	mm	mm	mm	kg	mm	mm	kg
2	2.375	7.00	2.75	4.4	3.25	2.75	2.5
50	60.3	178	70	2.0	83	70	1.1
2½	2.875	7.75	3.00	6.2	3.75	3.00	3.8
65	73.0	197	76	2.8	95	76	1.7
76.1	3.000	7.75	3.00	6.2	3.75	3.00	4.0
	76.1	197	76	2.8	95	76	1.8
3	3.500	8.50	3.25	9.2	4.25	3.25	5.5
80	88.9	216	83	4.2	108	83	2.5
4	4.500	10.50	3.75	17.6	5.00	3.75	10.4
100	114.3	267	95	8.0	127	95	4.7
139.7	5.500	12.50	4.00	27.5	5.50	4.00	15.0
	139.7	318	102	12.5	140	102	6.8
5	5.563	12.50	4.00	27.5	5.50	4.00	11.6
125	141.3	318	102	12.5	140	102	5.3
165.1	6.500	14.00	4.50	40.7	6.50	4.50	19.6
	165.1	356	114	18.5	165	114	8.9
6	6.625	14.00	4.50	40.7	6.50	4.50	19.6
150	168.3	356	114	18.5	165	114	8.9
8	8.625	18.00	6.00	70.4	7.75	6.00	34.3
200	219.1	457	152	32.0	197	152	15.6
10	10.750	20.50	6.50	138.9	-	-	-
250	273.0	521	165	63.0	-	-	-
12	12.750	23.00	7.00	201.7	10.00	7.00	79.4
300	323.9	584	178	91.5	254	178	36.0
14*	14.000	26.5	7.5	219.14	11.00	7.50	98.0
350	355.6	673	191	99.4	279	191	44.4

Grooved End Fittings  
Rev.20230217

Models 7130 / 7137

Nominal Size	Pipe O.D.	#7130 45° Lateral			#7137 True-Y		
		C - LE	C-SE	Weight	C-LE	C-SE	Weight
in	in	in	in	lbs	in	in	lbs
mm	mm	mm	mm	kg	mm	mm	kg
16*	16.000	29.0	8.0	270.5	12.00	8.00	119.3
400	406.4	737	203	122.7	305	203	54.1
18*	18.000	32.0	8.5	332.7	13.50	8.50	148.3
450	457.2	813	216	150.9	343	216	67.3
20*	20.000	35.0	9.0	401.3	15.00	9.00	180.4
500	508.0	889	229	182.0	381	229	81.8
22*	22.000	---	---	---	---	---	---
550	558.8	---	---	---	---	---	---
24*	24.000	40.0	10.0	541.3	17.00	10.00	238.3
600	609.6	1016	254	245.5	432	254	108.1

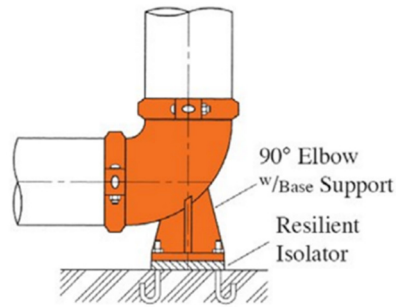
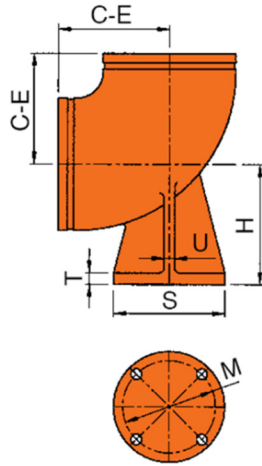

Model 7110-B 90° Elbow, Regular Radius with Base Support

Nominal Size	Pipe O.D.	Dimensions						weight
		C - E	H	U	T	S	M	
in	in	in	in	in	in	in	in	lbs
mm	mm	mm	mm	mm	mm	mm	mm	kg
3	3.500	4.25	4.88	0.50	0.56	5.00	3.88	10.5
80	88.9	108	124	13	14	127	99	4.8
4	4.500	5.00	5.50	0.50	0.62	6.00	4.75	15.2
100	114.3	127	140	13	16	152	121	6.9
6	6.625	6.50	7.00	0.62	0.69	7.00	5.50	26.3
150	168.3	165	178	16	18	178	140	11.9
8	8.625	7.76	8.38	0.88	0.94	9.00	7.50	56.9
200	219.1	197	213	22	24	229	191	25.8
10	10.750	9.02	9.75	0.88	0.94	9.00	7.50	88.9
250	273.0	229	248	22	24	229	191	40.3
12	12.750	10.00	11.25	1.00	1.00	11.00	9.50	70.4
300	323.9	254	286	25	25	279	241	32.0

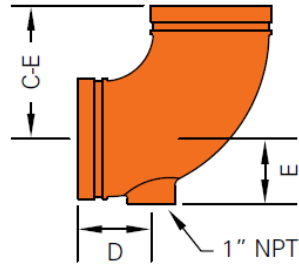

Model 7110DR Drain Elbow

Nominal Pipe Size	Pipe O.D.	Dimensions			Weight
		C-E	D	E	
in	in	in	in	in	lbs
mm	mm	mm	mm	mm	kg
2	2.375	3.27	2.25	1.57	2.2
50	60.3	83	57	40	1.0
2½	2.875	3.75	2.75	1.57	2.8
65	73.0	95	70	40	1.3
76.1	3.000	3.75	2.75	1.57	2.8
	76.1	95	70	40	1.3
3	3.500	4.25	2.75	1.93	4.6
80	88.9	108	70	49	2.1
4	4.500	5.00	2.75	2.48	6.6
100	114.3	127	70	63	3.0
165.1	6.500	6.50	2.75	3.54	13.4
	165.1	165	70	90	6.1
6	6.625	6.50	2.75	3.54	13.4
150	168.3	165	70	90	6.1
8	8.625	7.76	3.27	4.49	25.6
200	219.1	197	83	114	11.6

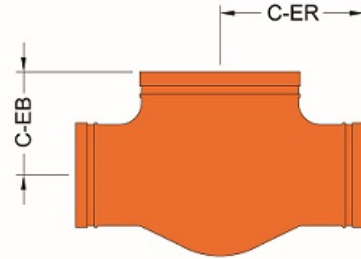

Model 7125 Bullhead Tee

Nominal Pipe Size	Pipe O.D.	Dimensions		Weight
		Center to End of Run C-ER	Center to End of Branch C-EB	
in	in	in	in	lbs
mm	mm	mm	mm	kg
2 x 2 x 2½	2.375 x 2.375 x 2.875	3.74	3.27	4.03
50 x 50 x 65	60.3 x 60.3 x 73.0	95	83	1.83
2 x 2 x 3	2.375 x 2.375 x 3.500	4.25	3.74	4.34
50 x 50 x 80	60.3 x 60.3 x 88.9	108	95	1.97
2 x 2 x 4	2.375 x 2.375 x 4.500	5.00	4.02	7.05
50 x 50 x 100	60.3 x 60.3 x 114.3	127	102	3.20
2½ x 2½ x 3	2.875 x 2.875 x 3.500	4.25	3.75	5.62
65 x 65 x 80	73.0 x 73.0 x 88.9	108	95	2.55
2½ x 2½ x 4	2.875 x 2.875 x 4.500	5.00	4.00	7.32
65 x 65 x 100	73.0 x 73.0 x 114.3	127	102	3.32
3 x 3 x 4	3.500 x 3.500 x 4.500	5.00	4.00	7.94
80 x 80 x 100	88.9 x 88.9 x 114.3	127	102	3.60
4 x 4 x 6	4.500 x 4.500 x 6.625	6.50	5.00	14.99
100x 100 x 150	114.3 x 114.3 x 168.3	165	127	6.80
5 x 5 x 8	5.563 x 5.563 x 8.625	7.75	5.50	31.00
125 x 125 x 200	141.3 x 141.3 x 219.1	197	140	14.00
6 x 6 x 8	6.625 x 6.625 x 8.625	7.75	6.50	29.12
150 x 150 x 200	168.3 x 168.3 x 219.1	197	165	13.21

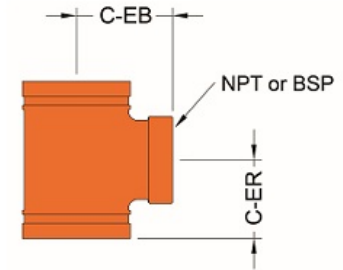

Model 7127 Standpipe Tee

Nominal Pipe Size	Pipe O.D.	Dimensions		Weight
		Center to End of Run C-ER	Center to End of Branch C-EB	
in	in	in	in	lbs
mm	mm	mm	mm	kg
4 x 4 x 2½	4.500 x 4.500 x 2.875	3.25	4.00	5.84
100 x 100 x 65	114.3 x 114.3 x 73.0	83	102	2.65
6 x 6 x 2½	6.625 x 6.625 x 2.875	3.25	5.00	9.48
150 x 150 x 65	168.3 x 168.3 x 73.0	83	127	4.30

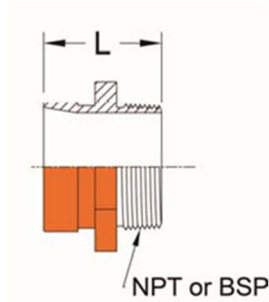

Model 55 Nipple Adapter

Nominal Size Grooves x Threaded		Pipe O.D.	L	Weight
in		in	in	lbs
mm		mm	mm	kg
1½ x 1½M		1.900	2.50	0.77
40 x 40M		48.3	63.5	0.35
2 x 2M		2.375	2.50	0.90
50 x 50M		60.3	63.5	0.40



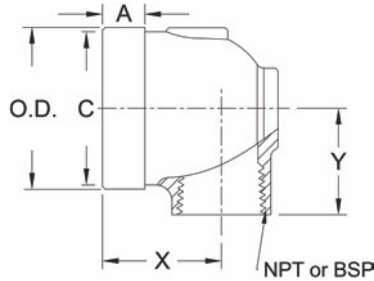

Model 899 End-All Fitting											
Nominal Size Grooved x Threaded	Pipe O.D.	Threads (NPT)	X	Y	A	C	Weight				
in	in		in	in	in	in	lbs				
mm	mm		mm	mm	mm	mm	kg				
1¼ x ½	1.660	½ - 14	1.750	1.190	0.625	1.535	0.7				
32 x 15			44.5	30.1							
1¼ x ¾	42.2	¾ - 14	1.750	1.190		0.625	39.0	0.3			
32 x 20			44.5	30.1							
1¼ x 1	1.900	1 - 1½	1.900	1.250			0.625	1.775	0.9		
32 x 25			48.3	31.8							
1½ x ½	1.900	½ - 14	1.750	1.313				0.625	1.775	0.9	
40 x 15			44.5	33.3							
1½ x ¾	48.3	¾ - 14	1.750	1.313					0.625	45.1	0.4
40 x 20			44.5	33.3							
1½ x 1	2.375	1 - 1½	1.900	1.375	15.9					57.2	0.5
40 x 25			48.3	34.9							
2 x ½	2.375	½ - 14	1.750	1.562		15.9				2.250	1.1
50 x 15			44.5	39.7							
2 x ¾	60.3	¾ - 14	1.750	1.562			15.9			57.2	0.5
50 x 20			44.5	39.7							
2 x 1	2.875	1 - 1½	1.900	1.625				15.9		2.720	1.3
50 x 25			48.3	41.3							
2½ x ½	2.875	½ - 14	1.750	1.750					15.9	2.720	1.3
65 x 15			44.5	44.5							
2½ x ¾	73.0	¾ - 14	1.750	1.750	15.9					69.1	0.6
65 x 20			44.5	44.5							
2½ x 1	2.875	1 - 1½	1.900	1.813		15.9				69.1	0.6
65 x 25			48.3	46.0							

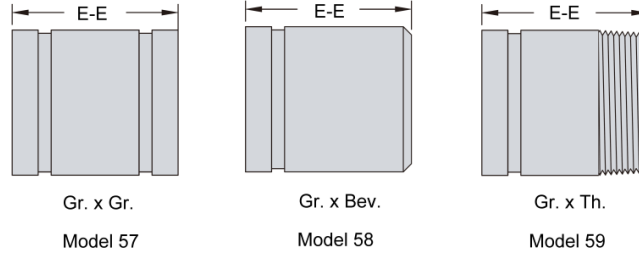

**Model 57 / 58 / 59 Nipples**

Nominal Pipe Size	Pipe O.D.	57 (Gr x Gr)		58 (Gr x Bev)		59 (Gr x Th)	
		E-E	Weight	E-E	Weight	E-E	Weight
in	in	in	lbs	in	lbs	in	lbs
mm	mm	mm	kg	mm	kg	mm	kg
¾	1.050	3	0.29	3	0.29	3	0.29
20	26.7	76	0.13	76	0.13	76	0.13
1	1.315	3	0.42	3	0.42	4	0.46
25	33.4	76	0.19	76	0.19	102	0.21
1¼	1.660	4	0.68	4	0.70	4	0.66
32	42.2	102	0.31	102	0.32	102	0.30
1¼	1.660	6	1.02	6	1.05	6	0.99
32	42.2	152	0.47	152	0.48	152	0.45
1½	1.900	---	---	---	---	3	0.60
40	48.3	---	---	---	---	76	0.27
1½	1.900	4	0.82	4	0.84	4	0.79
40	48.3	102	0.37	102	0.38	102	0.36
1½	1.900	6	1.22	6	1.26	6	1.19
40	48.3	152	0.56	152	0.57	152	0.54
2	2.375	---	---	---	---	3	0.83
50	60.3	---	---	---	---	76	0.38
2	2.375	4	1.10	4	1.10	4	1.10
50	60.3	102	0.50	102	0.50	102	0.50
2	2.375	6	1.65	6	1.65	6	1.65
50	60.3	152	0.75	152	0.75	152	0.75
2½	2.875	---	---	---	---	3	1.16
65	73.0	---	---	---	---	76	0.54
2½	2.875	4	1.76	4	1.76	4	1.54
65	73.0	102	0.80	102	0.80	102	0.72
2½	2.875	6	2.64	6	2.64	6	2.31
65	73.0	152	1.20	152	1.20	152	1.08

Grooved End Fittings  
Rev.20230217

Model 57 / 58 / 59 Nipples							
Nominal Pipe Size	Pipe O.D.	57 (Gr x Gr)		58 (Gr x Bev)		59 (Gr x Th)	
		E-E	Weight	E-E	Weight	E-E	Weight
in	in	in	lbs	in	lbs	in	lbs
mm	mm	mm	kg	mm	kg	mm	kg
76.1	3.000	---	---	---	---	3	1.49
	76.1	---	---	---	---	76	0.68
76.1	3.000	4	1.98	4	1.98	4	1.98
	76.1	102	0.90	102	0.90	102	0.90
76.1	3.000	6	2.97	6	2.97	6	2.97
	76.1	152	1.35	152	1.35	152	1.35
3	3.500	---	---	---	---	3	1.65
80	88.9	---	---	---	---	76	0.75
3	3.500	4	2.40	4	2.40	4	2.20
80	88.9	102	1.10	102	1.10	102	1.00
3	3.500	6	3.60	6	3.60	6	3.30
80	88.9	152	1.65	152	1.65	152	1.50
4	4.500	6	5.17	6	5.17	6	4.84
100	114.3	152	2.35	152	2.35	152	2.20
5	5.563	6	7.26	6	7.26	6	6.60
125	141.3	152	3.30	152	3.30	152	3.00
139.7	5.500	6	7.26	6	7.26	6	6.60
	139.7	152	3.30	152	3.30	152	3.00
6	6.625	6	9.90	6	9.90	6	9.81
150	168.3	152	4.50	152	4.50	152	4.46
165.1	6.500	6	9.46	6	9.46	6	9.81
	165.1	152	4.30	152	4.30	152	4.46
8	8.625	6	14.30	6	14.30	---	---
200	219.1	152	6.50	152	6.50	---	---
10	10.750	8	27.06	8	19.00	---	---
250	273.0	203	12.30	203	8.66	---	---

Model 57 / 58 / 59 Nipples							
Nominal Pipe Size	Pipe O.D.	57 (Gr x Gr)		58 (Gr x Bev)		59 (Gr x Th)	
		E-E	Weight	E-E	Weight	E-E	Weight
in	in	in	lbs	in	lbs	in	lbs
mm	mm	mm	kg	mm	kg	mm	kg
12	12.750	8	35.64	8	22.35	---	---
300	323.9	203	16.20	203	10.16	---	---
200 JIS	8.516	6	14.30	6	14.30	---	---
	216.3	152	6.50	152	6.50	---	---
250 JIS	10.528	8	27.06	8	19.00	---	---
	267.4	203	12.30	203	8.66	---	---
300 JIS	12.539	8	35.64	8	22.35	---	---
	318.5	203	16.20	203	10.16	---	---
14	14.000	8	36.38	8	36.38	---	---
350	355.6	203	16.50	203	16.50	---	---
16	16.000	8	41.67	8	41.67	---	---
400	406.4	203	18.90	203	18.90	---	---
18	18.000	8	47.19	8	47.19	---	---
450	457.0	203	21.40	203	21.40	---	---
20	20.000	8	52.48	8	52.48	---	---
500	508.0	203	23.80	203	23.80	---	---
24	24.000	8	63.28	8	63.28	---	---
600	610.0	203	28.70	203	28.70	---	---

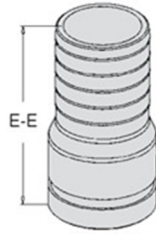

Model 56 Hose Nipple

Nominal Pipe Size		Pipe O.D.	E-E	Weight
In	mm	in	in	lbs
		mm	mm	kg
1		1.315	3.3	0.4
25		33.4	83	0.2
1¼		1.660	3.6	0.7
32		42.2	92	0.3
1½		1.900	4.0	0.7
40		48.3	102	0.3
2		2.375	4.6	1.2
50		60.3	117	0.6
2½		2.875	5.5	2.2
65		73.0	140	1.0
3		3.500	6.0	3.3
80		88.9	152	1.5
4		4.500	7.25	5.5
100		114.3	184	2.5
5		5.563	9.75	8.1
125		141.3	248	3.7
6		6.625	11.0	14.5
150		168.3	279	6.6
8		8.625	12.5	24.2
200		219.1	318	11.0
10		10.750	14.0	29.0
250		273.0	356	13.2
12		12.750	16.0	46.0
300		323.9	406	20.9

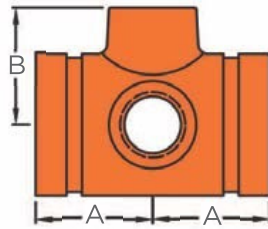

Model 850 Sprinkler Hub

Size	A	B	Weight
in	in	in	lbs
mm	mm	mm	kg
2 x 2 x 1 (3)	2.38	2.02	2.20
50 x 50 x 25 (3)	60	51	1.00
2½ x 2½ x 1 (3)	2.38	2.25	2.75
65 x 65 x 25 (3)	60	57	1.25

( ): Number of outlets

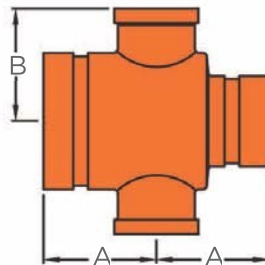

Model 851 Reducing Sprinkler Hub

Size	A	B	Weight
in	in	in	lbs
mm	mm	mm	kg
2 x 1½ x 1 (3)	2.38	2.02	2.20
50 x 40 x 25 (3)	60	51	1.00
2½ x 1½ x 1 (3)	2.38	2.25	2.65
65 x 40 x 25 (3)	60	57	1.20
2½ x 2 x 1 (3)	2.38	2.25	2.86
65 x 50 x 25 (3)	60	60	1.30

( ): Number of outlets

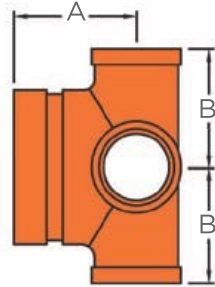

Model 853 Sprinkler Hub

Size	A	B	Weight
in	in	in	lbs
mm	mm	mm	kg
1½ x 1 (4)	2.38	1.80	1.76
40 x 25 (4)	60	46	0.8
2 x 1 (4)	2.38	2.02	2.20
50 x 25 (4)	60	51	1.00
2½ x 1 (4)	2.38	2.25	2.64
65 x 25 (4)	60	57	1.20

( ): Number of outlets

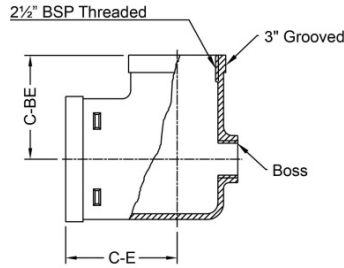

**Model 7114 Hydrant Elbow**

Nominal Pipe Size	Pipe O.D.	C-E	C-BE	Weight
in	in	in	in	lbs
mm	mm	mm	mm	kg
4 x 3 x 1	4.500 x 3.500 x 1.315	4.00	3.75	5.95
100 x 80 x 25	114.3 x 88.9 x 33.4	102	95	2.70
165.1 mm x 80 x 25	6.500 x 3.500 x 1.315	5.13	5.13	8.8
	165.1 x 88.9 x 33.4	130	130	4.0

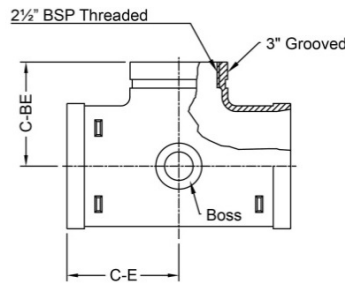

**Model 7122 Hydrant Tee**

Nominal Pipe Size	Pipe O.D.	C-E	C-BE	Weight
in	in	in	in	lbs
mm	mm	mm	mm	kg
4 x 4 x 3	4.500 x 4.500 x 3.500	4.00	4.00	7.72
100 x 100 x 80	114.3 x 114.3 x 88.9	102	102	3.50
165.1 mm x 165.1 mm x 80	6.500 x 6.500 x 3.500	5.13	5.13	12.21
	165.1 x 165.1 x 88.9	130	130	5.54



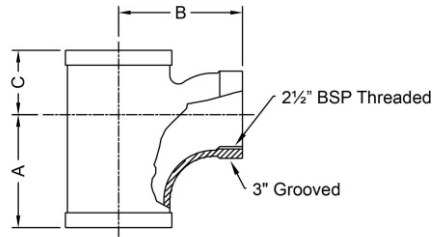

Model 7133 Pitcher Tee

Nominal Pipe Size	Pipe O.D.	Hydrant Outlet	Dimensions			Weight
			A	B	C	
mm	in		in	in	in	lbs
	mm		mm	mm	mm	kg
80 x 80 x 76.1 mm	3.500 x 3.500 x 3.000	Taper	4.75	4.75	2.72	6.2
	88.9 x 88.9 x 76.1	BSP	121	121	69	2.8
100 x 100 x 76.1 mm	4.500 x 4.500 x 3.000	Taper	4.75	5.25	2.72	7.5
	114.3 x 114.3 x 76.1	BSP	121	133	69	3.4
150 x 150 x 76.1 mm	6.500 x 6.500 x 3.000	Taper	4.75	6.25	2.72	19.1
	165.1 x 165.1 x 76.1	BSP	121	159	69	8.7

**MODEL W131 45° REDUCING LATERAL**

Material: Fabricated with ASTM A234 Gr. WPB, standard weight (0.375" or 9.5 mm), or segmentally welded carbon steel of the same or equivalent grade.

C-LE and C-SE dimensions: manufacturer's standard.

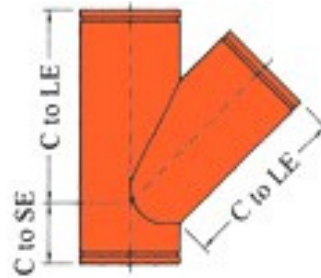

Model W131 45° Lateral					
Nominal Pipe Size	Pipe O.D.	C-LE	C-SE	Weight	
in	in	in	in	lbs	
mm	mm	mm	mm	kg	
14 x 14 x 4	14.000 x 14.000 x 4.500	26.5	7.5	175.9	
350 x 350 x 100	355.6 x 355.6 x 114.3	673	191	79.8	
14 x 14 x 6	14.000 x 14.000 x 6.625	26.5	7.5	185.9	
350 x 350 x 150	355.6 x 355.6 x 168.3	673	191	84.3	
14 x 14 x 8	14.000 x 14.000 x 8.625	26.5	7.5	195.0	
350 x 350 x 200	355.6 x 355.6 x 219.1	673	191	88.4	
14 x 14 x 10	14.000 x 14.000 x 10.750	26.5	7.5	204.4	
350 x 350 x 250	355.6 x 355.6 x 273.0	673	191	92.7	
14 x 14 x 12	14.000 x 14.000 x 12.750	26.5	7.5	213.3	
350 x 350 x 300	355.6 x 355.6 x 323.9	673	191	96.8	
16 x 16 x 6	16.000 x 16.000 x 6.625	29.0	8.0	226.4	
400 x 400 x 150	406.4 x 406.4 x 168.3	737	203	102.7	
16 x 16 x 8	16.000 x 16.000 x 8.625	29.0	8.0	236.0	
400 x 400 x 200	406.4 x 406.4 x 219.1	737	203	107.1	
16 x 16 x 10	16.000 x 16.000 x 10.750	29.0	8.0	246.0	
400 x 400 x 250	406.4 x 406.4 x 273.0	737	203	111.6	
16 x 16 x 12	16.000 x 16.000 x 12.750	29.0	8.0	255.1	
400 x 400 x 300	406.4 x 406.4 x 323.9	737	203	115.7	
16 x 16 x 14	16.000 x 16.000 x 14.000	29.0	8.0	260.9	
400 x 400 x 350	406.4 x 406.4 x 355.6	737	203	118.4	
18 x 18 x 6	18.000 x 18.000 x 6.625	32.0	8.5	274.8	
450 x 450 x 150	457.2 x 457.2 x 168.3	813	216	124.6	
18 x 18 x 8	18.000 x 18.000 x 8.625	32.0	8.5	285.3	
450 x 450 x 200	457.2 x 457.2 x 219.1	813	216	129.4	
18 x 18 x 12	18.000 x 18.000 x 12.750	32.0	8.5	306.2	
450 x 450 x 300	457.2 x 457.2 x 323.9	813	216	138.9	
18 x 18 x 14	18.000 x 18.000 x 14.000	32.0	8.5	312.4	
450 x 450 x 350	457.2 x 457.2 x 355.6	813	216	141.7	
18 x 18 x 16	18.000 x 18.000 x 16.000	32.0	8.5	322.4	
450 x 450 x 400	457.2 x 457.2 x 406.4	813	216	146.2	

Model W131 45° Lateral					
Nominal Pipe Size		Pipe O.D.	C-LE	C-SE	Weight
in		in	in	in	lbs
mm		mm	mm	mm	kg
20 x 20 x 12		20.000 x 20.000 x 12.750	35.0	9.0	362.1
500 x 500 x 300		508.0 x 508.0 x 323.9	889	229	164.3
20 x 20 x 14		20.000 x 20.000 x 14.000	35.0	9.0	368.7
500 x 500 x 350		508.0 x 508.0 x 355.6	889	229	167.2
20 x 20 x 16		20.000 x 20.000 x 16.000	35.0	9.0	379.4
500 x 500 x 400		508.0 x 508.0 x 406.4	889	229	172.1
24 x 24 x 16		24.000 x 24.000 x 16.000	40.0	10.0	494.9
600 x 600 x 400		609.6 x 609.6 x 406.4	1016	254	224.5
24 x 24 x 20		24.000 x 24.000 x 20.000	40.0	10.0	517.7
600 x 600 x 500		609.6 x 609.6 x 508.0	1016	254	254.8

**MODEL 7170 FLANGE ADAPTER ANSI CLASS 125/150**

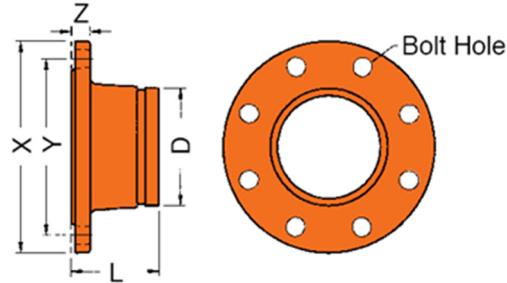

Model 7170 Flange Adapter ANSI Class 125/150

Nominal Pipe Size	X	Y	Z	Bolt Size	Bolt Hole		D	L	Weight
					Dia.	No.			
in	in	in	in	in	in		in	in	lbs
mm	mm	mm	mm	in	in		mm	mm	kg
10	15.98	14.25	1.18	7/8	1	12	10.75	5.00	48.4
250	406.0	362.0	30.0	7/8	1	12	273.0	127.0	22.0
12	19.00	17.00	1.25	7/8	1	12	12.75	5.00	61.6
300	483.0	432.0	32.0	7/8	1	12	323.9	127.0	28.0
14	21.00	18.75	1.38	1	1 1/8	12	14.00	5.00	108.9
350	533.0	476.3	35.0	1	1 1/8	12	355.6	127.0	49.5
16	23.50	21.25	1.46	1	1 1/8	16	16.00	5.00	110.0
400	597.0	539.7	37.0	1	1 1/8	16	406.4	127.0	50.0
18	25.00	22.75	1.57	1 1/8	1 1/4	16	18.00	5.50	137.5
450	635.0	577.8	40.0	1 1/8	1 1/4	16	457.2	140.0	62.5
20	27.50	25.00	1.69	1 1/8	1 1/4	20	20.00	5.71	158.4
500	699.0	635.0	43.0	1 1/8	1 1/4	20	508.0	145.0	72.0
24	32.00	29.50	1.89	1 1/4	1 3/8	20	24.00	6.00	218.9
600	813.6	749.3	48.0	1 1/4	1 3/8	20	609.6	152.0	99.5

**MODEL 7170 FLANGE ADAPTER ANSI CLASS 300 (Fabricated)**

The Model 7170 Flange Adapter (fabricated) in sizes 2" ~ 6" provide a direct connection to Class 300 flanges.

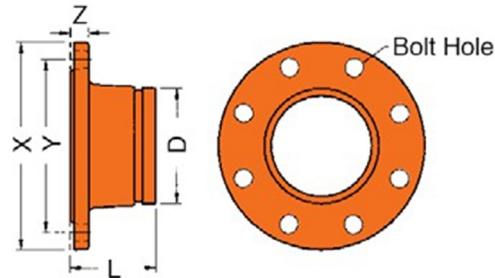

Model 7170 Flange Adapter ANSI Class 300

Nominal Pipe Size	X	Y	Z	Bolt Size	Bolt Hole		D	L	Weight
					Dia.	No.			
in	in	in	in	in	in		in	in	lbs
mm	mm	mm	mm				mm	mm	kg
2	6.50	5.000	0.875				2.375	4.00	8.58
50	165.0	127.0	22.0	5/8	3/4	8	60.3	101.6	3.9
2½	7.50	5.875	1.000				3.000	4.00	10.12
65	191.0	149.0	25.0	3/4	7/8	8	76.1	101.6	4.6
3	8.25	6.625	1.125				3.500	4.00	10.34
80	210.0	168.0	29.0	3/4	7/8	8	88.9	101.6	4.7
4	10.00	7.875	1.250				4.500	6.00	16.94
100	254.0	200.0	32.0	3/4	7/8	8	114.3	152.4	7.7
6	12.50	10.625	1.438				6.500	6.00	28.60
150	318.0	270.0	37.0	3/4	7/8	12	165.1	152.4	13.0

**MODEL 7170 FLANGE ADAPTER PN 25 (Fabricated)**

The Model 7170 Flange Adapter (fabricated) in sizes 2" ~ 16" provide a direct connection to PN 25 flanges.

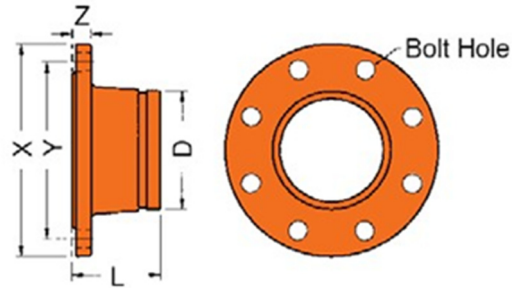

Model 7170 Flange Adapter PN 25

Nominal Pipe Size	X	Y	Z	Bolt Size	Bolt Hole		D	L	Weight
					Dia.	No.			
mm	mm	mm	mm	mm	mm		mm	mm	kg
50	165.0	125.0	20.0	M16	18.0	4	60.3	101.6	3.0
65	165.0	145.0	22.0	M16	18.0	8	73.0	101.6	4.0
65	185.0	145.0	22.0	M16	18.0	8	76.1	101.6	4.0
80	200.0	160.0	24.0	M16	18.0	8	88.9	101.6	5.0
100	235.0	190.0	24.0	M20	22.0	8	114.3	152.4	6.5
125	270.0	220.0	26.0	M24	26.0	8	141.3	152.4	9.0
150	300.0	250.0	28.0	M24	26.0	8	165.1	152.4	11.5
200	360.0	310.0	32.0	M24	26.0	12	219.1	152.4	17.0
250	425.0	370.0	35.0	M27	30.0	12	273.0	203.2	24.0
300	485.0	430.0	38.0	M27	30.0	16	323.9	203.2	31.5
350	555.0	490.0	42.0	M30	33.0	16	355.6	203.2	48.0
400	620.0	550.0	46.0	M33	36.0	16	406.4	203.2	63.0

**MODEL W170 FLANGE ADAPTER  
PN 10/16**

The Model W170 Flange Adapter fabricated in sizes 10" ~ 24" (250 mm ~ 600 mm) provide a direct connection to PN 10/16 flanges. Dimensions conform to BS EN 1092.

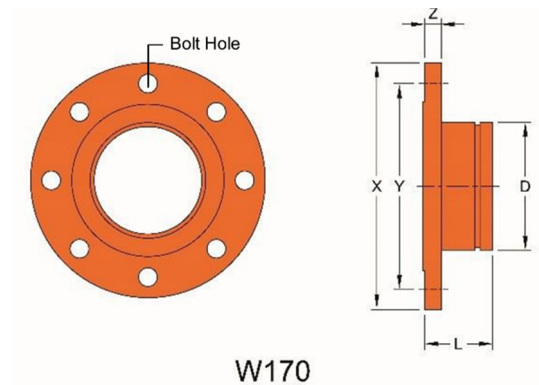

**Model W170 Flange Adapter - PN 10**

Nominal Pipe Size	X	Y	Z	Bolt Size	Bolt Hole		D	L	Weight
					Dia.	No.			
mm	mm	mm	mm		mm		mm	mm	kg
250	395.0	350.0	26	M20	22.0	12	273.0	114.0	18.2
300	445.0	400.0	26	M20	22.0	12	323.9	114.0	21.4
350	505.0	460.0	30	M20	22.0	16	355.6	127.0	31.1
400	565.0	515.0	32	M24	26.0	16	406.4	127.0	38.1
450	615.0	565.0	36	M24	26.0	20	457.0	152.0	48.2
500	670.0	620.0	38	M24	26.0	20	508.0	152.0	56.4
600	780.0	725.0	42	M27	30.0	20	610.0	152.0	74.0

**Model W170 Flange Adapter - PN 16**

Nominal Pipe Size	X	Y	Z	Bolt Size	Bolt Hole		D	L	Weight
					Dia.	No.			
mm	mm	mm	mm		mm		mm	mm	kg
250	405.0	355.0	29	M24	26.0	12	273.0	114	20.4
300	460.0	410.0	32	M24	26.0	12	323.9	114	26.5
350	520.0	470.0	35	M24	26.0	16	355.6	140	38.1
400	580.0	525.0	38	M27	30.0	16	406.4	140	47.2
450	640.0	585.0	42	M27	30.0	20	457.0	165	61.4
500	715.0	650.0	46	M30	33.0	20	508.0	165	80.4
600	840.0	770.0	55	M33	36.0	20	610.0	190	123.8

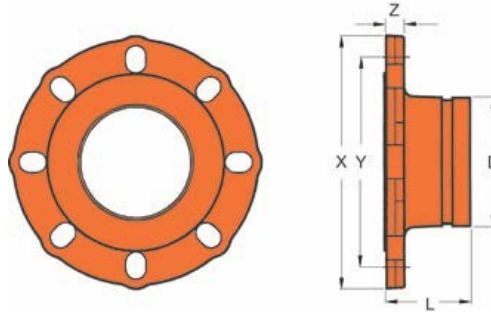

Model 7180 Universal Flange Adapter

Nominal Size	Pipe O.D.	L	X	Y: Flange Drilling				Z	Bolts		Weight
				ANSI 125/150	PN 10/16	JIS 10K	BS 10E		Dia.	No.	
in	in	in	in	in	in	in	in	in	in		lbs
mm	mm	mm	mm	mm	mm	mm	mm	mm	mm		kg
2	2.375	2.50	6.50	4.75	4.92	4.72	4.49	0.63	5/8	4	5.10
50	60.3	64	165	121	125	120	114	16	M16	4	2.30
2½	2.875	2.99	7.28	5.50	5.70	5.50	5.00	0.63	5/8	4	6.53
65	73.0	76	185	140	145	140	127	16	M16	4	2.96
76.1	3.000	2.99	7.28	5.50	5.70	5.50	5.00	0.63	5/8	4	6.40
	76.1	76	185	140	145	140	127	16	M16	4	2.90
3	3.500	2.95	7.87	6.00	6.30	5.90	5.75	0.63	5/8	4 / 8	7.47
80	88.9	75	200	152	160	150	146	16	M16	4 / 8	3.39
4	4.500	2.95	8.86	7.50	7.09	6.89	7.00	0.63	5/8	8	8.49
100	114.3	75	225	191	180	175	178	16	M16	8	3.85
139.7	5.500	2.95	10.00	8.50	8.27	8.27	8.27	0.87	5/8 / 3/4	8	14.33
	139.7	75	254	216	210	210	210	22	M16 / M20	8	6.50
5	5.563	2.95	10.00	8.50	8.27	8.27	---	0.87	5/8 / 3/4	8	14.33
125	141.3	75	254	216	210	210	--	22	M16 / M20	8	6.50
165.1	6.500	2.95	10.71	9.50	9.45	9.45	9.30	0.63	3/4	8	13.86
	165.1	75	272	241	240	240	235	16	M20	8	6.30
6	6.625	2.95	10.71	9.50	9.45	9.45	---	0.63	3/4	8	12.58
150	168.3	75	272	241	240	240	--	16	M20	8	5.72
8	8.625	4.00	13.50	11.75	11.61	11.42	11.50	0.87	3/4	8 / 12	30.09
200	219.1	102	343	298	295	290	292	22	M20	8 / 12	13.65
200 JIS	8.516	4.00	13.50	11.75	11.61	11.42	---	0.87	3/4	8 / 12	30.09
	216.3	102	343	298	295	290	--	22	M20	8 / 12	13.65

Grooved End Fittings Rev.20230217



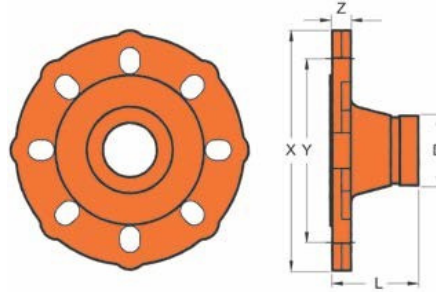

Model 7181 Universal Reducing Flange Adapter

Nominal Size	Pipe O.D.	L	X	Z	Y: Flange Drilling			D	Bolts		Weight
					ANSI 125 / 150	PN 10, 16	JIS 10K		Dia.	No.	
in	in	in	in	in	in	in	in	in			lbs
mm	mm	mm	mm	mm	mm	mm	mm	mm	mm		kg
3 x 2	3.500 x 2.375	2.95	8.19	0.63	8.00	6.30	5.90	2.000	5/8	8	5.95
80 x 50	88.9 x 60.3	75.0	208.0	16.0	152	160	150	60.3	M16	8	2.70
4 x 2½	4.500 x 2.875	3.00	8.88	0.63	7.52	7.09	6.89	2.875	5/8	8	8.80
100 x 65	114.3 x 73.0	76.0	225.5	16.0	191	180	175	73.0	M16	8	4.00
100 x 76.1	4.500 x 3.000	3.00	8.88	0.63	7.52	7.09	6.89	3.000	5/8	8	8.80
	114.3 x 76.1	76.0	225.5	16.0	191	180	175	76.1	M16	8	4.00
4 x 3	4.500 x 3.500	2.95	8.88	0.63	7.50	7.09	6.89	3.000	5/8	8	7.61
100 x 80	114.3 x 88.9	75.0	225.5	16.0	191	180	175	88.9	M16	8	3.45
6 x 4	6.625 x 4.500	2.95	11.46	0.95	9.50	9.45	9.45	4.000	¾	8	15.61
150 x 100	168.3 x 114.3	75.0	291.0	24.0	241	240	240	114.3	M20	8	7.08

### General note

- *Pressure Ratings* for fittings conform to the working pressure of the coupling used to join the system.
- Listed and or Approved Pressures are pressure ratings for fire protection systems, tested and approved by various approval bodies. Please always refer to the latest approval data posted on the Shurjoint website.
- Field Joint Test: For one time, only the system may be tested hydrostatically at 1½ times the maximum working pressure listed (AWWA C606 5.2.3).
- Warning: Piping systems must always be depressurized and drained before attempting disassembly and or removal of any components.
- The 10 Year Limited Warranty applies to manufacturing defects only and does not cover severe service/temperature applications or wear parts.
- Shurjoint reserves the right to change specifications, designs and or standard without notice and without incurring any obligations.