

intercable

Datasheet Al/Cu Verbinders Al - 25mm² rm/sm, 35mm² se / Cu – 16mm² rm/sm DIN46267

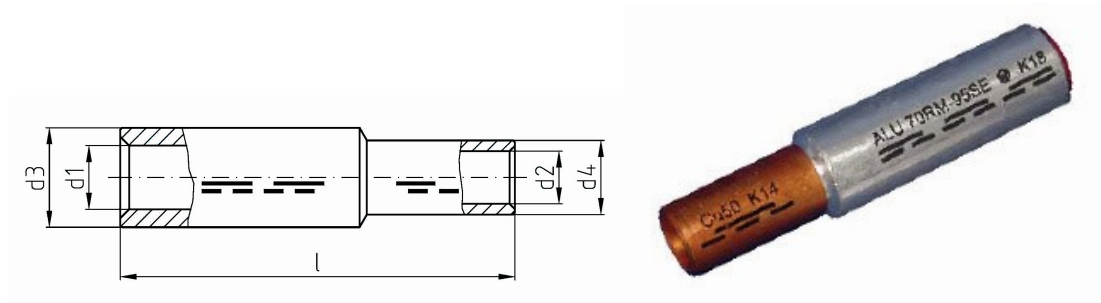

Artikelnummer	ICALCU2516V
Doorsnede kabel	
Rond/Sector meerdradig	25mm ²
Sector enkeldradig	35mm ²
Koper (Cu) Rond/ Sector meerdradig	16mm ²
Materiaal	Al 99,5/ CU-ETP vlgns. DIN13601
Afwerking	Blank, met contactvet gevuld, gesloten
Referentienummer (kengetal) t.b.v. matrijsnummer)	Al 12 / CU 8

Maten:

D1	6.8mm
D3	12mm
D2	5.5mm
D4	8.5mm
L	61
Gewicht	1.61kg/100
	kg Cu/100