

intercable

Datasheet Kabelschoen 25mm² M10

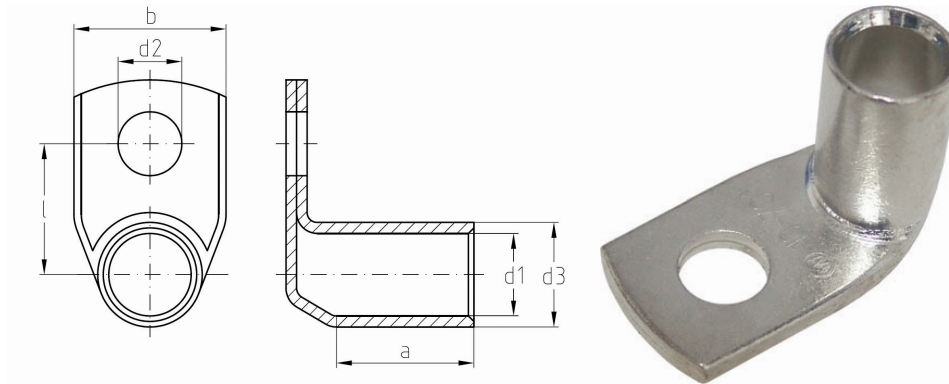

Artikelnummer	ICF251090
Doorsnede Kabel	25 mm ²
Gatmaat	M10
Materiaal	CU-HCP 99,95% vlgns DIN EN 13600
Afwerking	Galvanisch vertind

Maten:

D1	7,70 mm
D3	10,70 mm
D2	10,50 mm
B	18,00 mm
L	19,90 mm
A	15,00 mm
Gewicht	1,89 kg/100