

intercable

Datasheet Al/Cu Verbinders Al - 70mm² rm/sm, 95mm² se / Cu – 70mm² rm/sm DIN46267

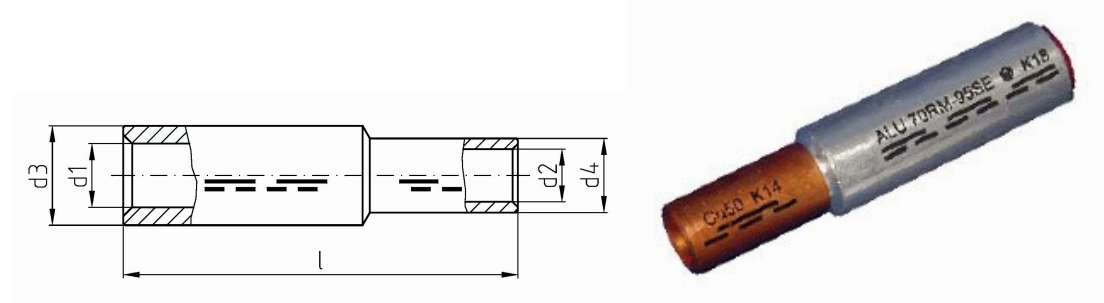

Artikelnummer	ICALCU7070V
Doorsnede kabel	
Rond/Sector meerdradig	70mm ²
Sector enkeldradig	95mm ²
Koper (Cu) Rond/ Sector meerdradig	70mm ²
Materiaal	Al 99,5/ CU-ETP vlgns. DIN13601
Afwerking	Blank, met contactvet gevuld, gesloten
Referentienummer (kengetal) t.b.v. matrijsnummer)	Al 18 / CU 16

Maten:

D1	11.2mm
D3	0mm
D2	11.5mm
D4	16.5mm
L	88
Gewicht	6.4kg/100
	kg Cu/100