

intercable

Datasheet Kabelschoen 25mm² M12

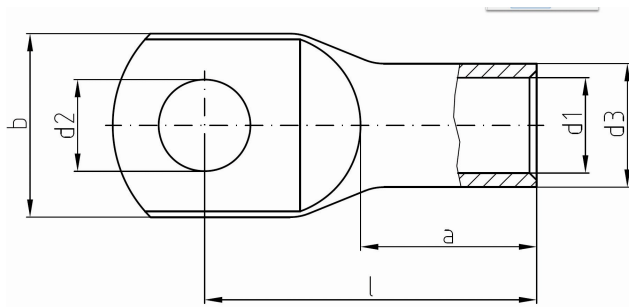

Artikelnummer	ICF2512
Doorsnede Kabel	25 mm ²
Gatmaat	M12
Materiaal	CU-HCP 99,95% vlgns DIN EN 13600
Afwerking	Galvanisch vertind

Maten:

D1	0mm
D3	0mm
D2	13mm
B	20mm
L	36mm
A	16mm
Gewicht	1.65 kg/100