

intercable

Datasheet Kabelschoen 10mm² M12

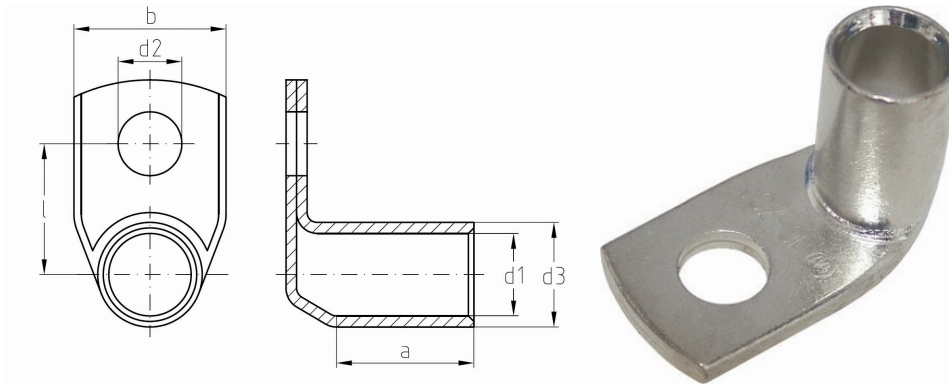

Artikelnummer	ICF101290
Doorsnede Kabel	10 mm ²
Gatmaat	M12
Materiaal	CU-HCP 99,95% vlgns DIN EN 13600
Afwerking	Galvanisch vertind

Maten:

D1	5,00 mm
D3	8,00 mm
D2	13,00 mm
B	20,00 mm
L	19,00 mm
A	11,00 mm
Gewicht	0,98 kg/100