

*intercable*

## Datasheet Kabelschoen 16mm<sup>2</sup> M6

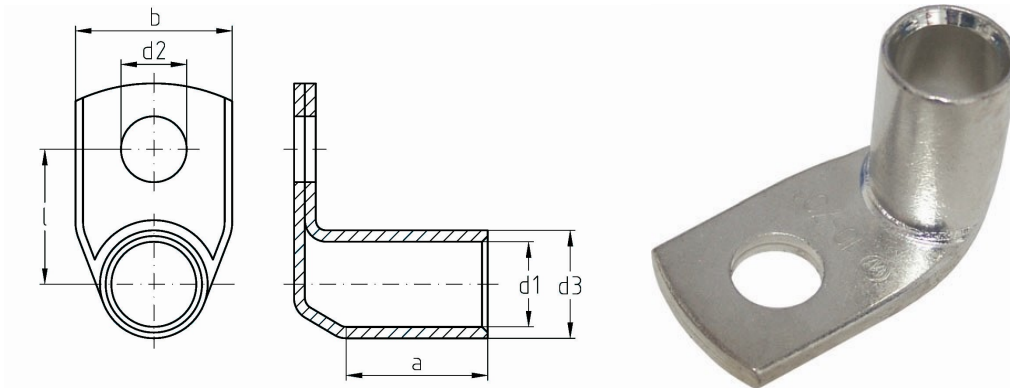

<b>Artikelnummer</b>	ICR16690
<b>Doorsnede Kabel</b>	16 mm <sup>2</sup>
<b>Gatmaat</b>	M6
<b>Materiaal</b>	CU-HCP 99,95% vlgns DIN EN 13600
<b>Afwerking</b>	Galvanisch vertind

### Maten:

<b>D1</b>	5.5mm
<b>D3</b>	8.5mm
<b>D2</b>	6.4mm
<b>B</b>	12
<b>L</b>	14.3
<b>A</b>	12
<b>Gewicht</b>	1.15 kg/100