

intercable

Datasheet Kabelschoen 50mm² M16

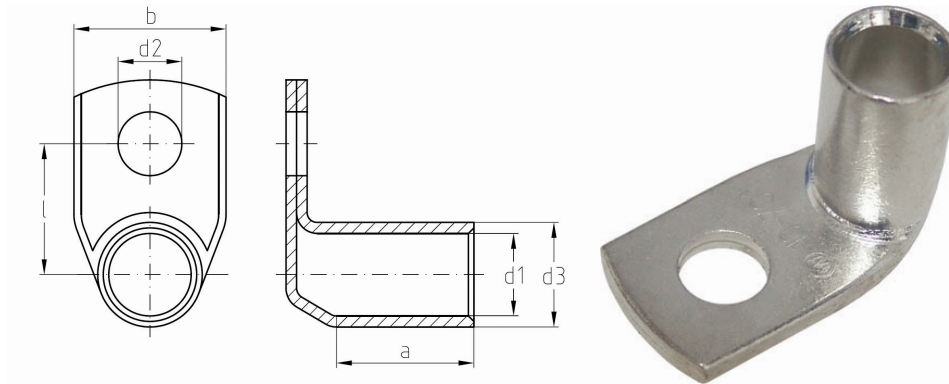

Artikelnummer	ICF501690
Doorsnede Kabel	50 mm ²
Gatmaat	M16
Materiaal	CU-HCP 99,95% vlgns DIN EN 13600
Afwerking	Galvanisch vertind

Maten:

D1	11,20 mm
D3	14,80 mm
D2	17,00 mm
B	88,00 mm
L	25,90 mm
A	20,00 mm
Gewicht	3,57 kg/100