

intercable

Datasheet Kabelschoen 300mm² M16

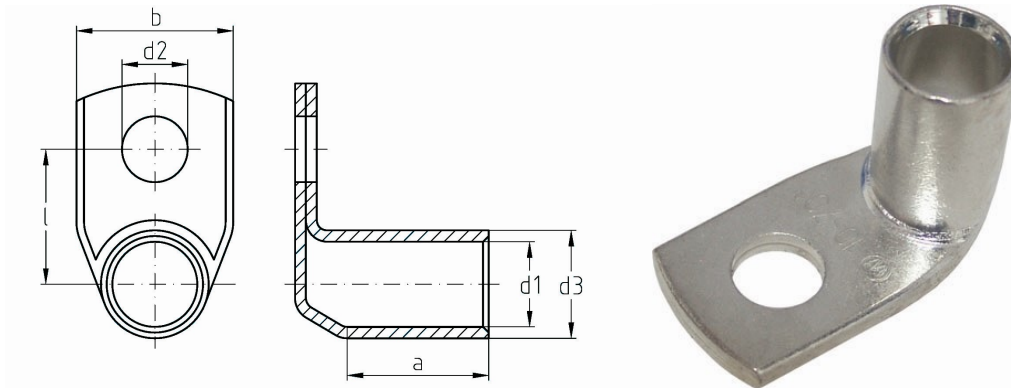

Artikelnummer	ICR3001690
Doorsnede Kabel	300 mm ²
Gatmaat	M16
Materiaal	CU-HCP 99,95% vlgns DIN EN 13600
Afwerking	Galvanisch vertind

Maten:

D1	24mm
D3	30mm
D2	17mm
B	43
L	34
A	41
Gewicht	19.7 kg/100