

intercable

Datasheet Kabelschoen 6mm² M10

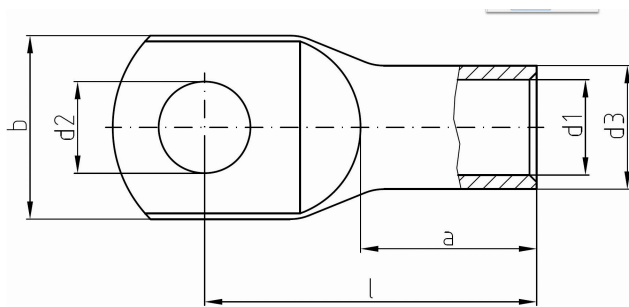

Artikelnummer	ICR610
Doorsnede Kabel	6
Gatmaat	M10
Aantal Persingen	
Materiaal	CU-HCP 99,95% vlgns DIN EN 13600
Afwerking	Galvanisch vertind

Maten:

D1	3.5mm
D3	6.5mm
D2	10.5mm
B	18mm
L	26mm
A	9mm
Gewicht	0.64 kg/100