

*intercable*

## Datasheet Plaatkabelschoen Stift 10mm<sup>2</sup>

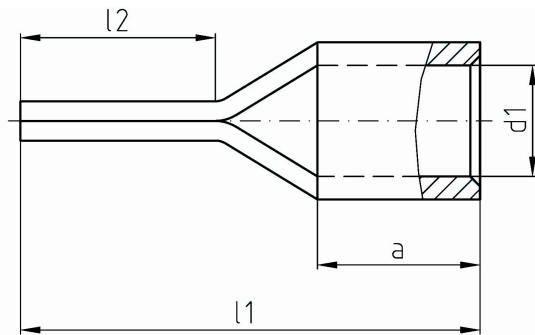

<b>Artikelnummer</b>	ICQ10ST
<b>Doorsnede Kabel</b>	10 mm <sup>2</sup>
<b>Materiaal</b>	CU-HCP 99,95% vlgns DIN EN 13600
<b>Afwerking</b>	Galvanisch vertind

### Maten:

<b>D1</b>	4.5mm
<b>L1</b>	22mm
<b>L2</b>	12mm
<b>A</b>	8mm
<b>Ø Stift</b>	2,3 x 4,2mm
<b>Gewicht</b>	0.25 kg/100