



Sample image

## Datasheet

**Article number:** 70002296  
**Designation:** CA10.A213.FT2  
**Description:** Schalter  
**Contact development:** A213  
**Face plate engraving:** F071  
**Type of mounting:** FT2





Type Size: S0
Classification Contact: Rigid contact bridge
Classification Contact Mat: Silver
Classification Terminal: Screw terminal

IEC 60947-3 EN 60947-3, VDE 0660 Teil 107						
<b>Rated insulation voltage U<sub>i</sub></b>						
			Voltage (V) AC / DC			
			690 AC / DC			
<b>Rated impulse withstand voltage U<sub>imp</sub></b>						
Voltage (kV)	Overvoltage category	Pollution degree	Supply system		Function	
6 III		3	Valid for lines with grounded common neutral termination		switch	
4 III		3	Valid for lines with grounded common neutral termination		Switch disconnecter	
<b>Rated uninterrupted current I<sub>u</sub>/I<sub>th</sub></b>						
Current (A)	Ambient temperature (°C)	Peak temperature (°C)	additional requirements			
20	55	60	Ambient temperature +55°C during 24 hours with peaks up to +60°C			
<b>Conventional enclosed thermal current I<sub>thc</sub></b>						
Current (A)	Ambient temperature (°C)	Peak temperature (°C)	Additional requirements	No. of stages (from - to)	Mounting	Mounting size
20	35	40	Ambient temperature +35°C during 24 hours with peaks up to +40°C	--	--	--
<b>Rated operational current I<sub>e</sub></b>						
Utilization category			Voltage (V)		Current (A)	
AC-15			220 - 240		6	
AC-15			380 - 440		4	
AC-20A			690		20	
AC-21A			20 - 690		20	
AC-22A			220 - 500		20	
AC-22A			660 - 690		20	
<b>Rated operational power</b>						
Utilization category	Voltage (V)	No. of phases	No. of poles		Power (kW)	
AC-6b	380 - 400	3	3		--	
AC-6b	220 - 230	1	2		--	
AC-2	220 - 240	3	3		4	
AC-2	380 - 440	3	3		7,50	
AC-2	500 - 500	3	3		10	
AC-2	660 - 690	3	3		10	
AC-3	220 - 240	3	3		3	
AC-3	380 - 440	3	3		5,50	
AC-3	500 - 500	3	3		5,50	
AC-3	660 - 690	3	3		5,50	
AC-3	110 - 120	1	2		0,60	
AC-3	220 - 240	1	2		2,20	
AC-3	380 - 440	1	2		3	
AC-4	220 - 240	3	3		0,55	
AC-4	380 - 440	3	3		1,50	
AC-4	500 - 500	3	3		1,50	
AC-4	660 - 690	3	3		1,50	
AC-4	110 - 120	1	2		0,30	
AC-4	220 - 240	1	2		0,75	
AC-4	380 - 440	1	2		1,50	
AC-23A	220 - 240	3	3		3,70	
AC-23A	380 - 440	3	3		7,50	
AC-23A	500 - 500	3	3		7,50	
AC-23A	660 - 690	3	3		7,50	
AC-23A	110 - 120	1	2		0,75	
AC-23A	220 - 240	1	2		2,50	
AC-23A	380 - 440	1	2		3,70	

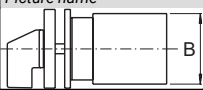

<b>Max Fuse Rating IEC</b>					
<i>Fuse characteristic</i>			<i>No. of Fuses</i>	<i>Current (A)</i>	
gG			1	25	
<b>Tested AC and DC values</b>					
<i>Utilization category / Time constant</i>	<i>No. of contacts in series</i>	<i>Off or change-over switch</i>	<i>Voltage (V) AC / DC</i>		<i>Current (A)</i>
DC-13	1	ON - OFF	24 DC		3
DC-13	1	ON - OFF	48 DC		1,70
DC-13	1	ON - OFF	60 DC		1,40
DC-13	1	ON - OFF	110 DC		0,70
DC-13	1	ON - OFF	220 DC		0,15
DC-13	2	ON - OFF	24 DC		6
DC-13	2	ON - OFF	48 DC		3
DC-13	2	ON - OFF	96 DC		1,70
DC-13	2	ON - OFF	120 DC		1,40
DC-13	2	ON - OFF	220 DC		0,70
DC-13	2	ON - OFF	440 DC		0,15
DC-21A	1	ON - OFF	24 DC		20
DC-21A	1	ON - OFF	48 DC		20
DC-21A	1	ON - OFF	60 DC		20
DC-21A	1	ON - OFF	110 DC		6
DC-21A	1	ON - OFF	220 DC		0,90
DC-21A	2	ON - OFF	48 DC		16
DC-21A	2	ON - OFF	96 DC		14
DC-21A	2	ON - OFF	120 DC		13
DC-21A	2	ON - OFF	220 DC		6
DC-21A	2	ON - OFF	440 DC		0,90
DC-21A	3	ON - OFF	72 DC		16
DC-21A	3	ON - OFF	144 DC		14
DC-21A	3	ON - OFF	180 DC		13
DC-21A	3	ON - OFF	330 DC		6
DC-21A	3	ON - OFF	660 DC		0,90
DC-21A	4	ON - OFF	96 DC		16
DC-21A	4	ON - OFF	192 DC		14
DC-21A	4	ON - OFF	240 DC		13
DC-21A	4	ON - OFF	440 DC		6
DC-21A	5	ON - OFF	120 DC		16
DC-21A	5	ON - OFF	240 DC		14
DC-21A	5	ON - OFF	300 DC		13
DC-21A	5	ON - OFF	550 DC		6
DC-21A	6	ON - OFF	144 DC		16
DC-21A	6	ON - OFF	288 DC		14
DC-21A	6	ON - OFF	360 DC		13
DC-21A	6	ON - OFF	660 DC		6
DC-21A	8	ON - OFF	192 DC		16
DC-21A	8	ON - OFF	384 DC		14
DC-21A	8	ON - OFF	480 DC		13
DC-22A	1	ON - OFF	24 DC		20
DC-22A	1	ON - OFF	48 DC		20
DC-22A	1	ON - OFF	60 DC		12
DC-22A	1	ON - OFF	110 DC		1,90
DC-22A	1	ON - OFF	220 DC		0,30
DC-22A	2	ON - OFF	48 DC		14
DC-22A	2	ON - OFF	96 DC		13
DC-22A	2	ON - OFF	120 DC		12
DC-22A	2	ON - OFF	220 DC		1,90
DC-22A	2	ON - OFF	440 DC		0,30
DC-22A	3	ON - OFF	72 DC		14
DC-22A	3	ON - OFF	144 DC		13
DC-22A	3	ON - OFF	180 DC		12
DC-22A	3	ON - OFF	330 DC		1,90
DC-22A	3	ON - OFF	660 DC		0,30
DC-22A	4	ON - OFF	96 DC		14
DC-22A	4	ON - OFF	192 DC		13
DC-22A	4	ON - OFF	240 DC		12
DC-22A	4	ON - OFF	440 DC		1,90
DC-22A	5	ON - OFF	120 DC		14
DC-22A	5	ON - OFF	240 DC		13
DC-22A	5	ON - OFF	300 DC		12
DC-22A	5	ON - OFF	550 DC		1,90
DC-22A	6	ON - OFF	144 DC		14
DC-22A	6	ON - OFF	288 DC		13
DC-22A	6	ON - OFF	360 DC		12
DC-22A	6	ON - OFF	660 DC		1,90
DC-22A	8	ON - OFF	192 DC		14
DC-22A	8	ON - OFF	384 DC		13
DC-22A	8	ON - OFF	480 DC		12
DC-23A	1	ON - OFF	24 DC		20
DC-23A	1	ON - OFF	48 DC		20

<b>Tested AC and DC values</b>					
<i>Utilization category / Time constant</i>	<i>No. of contacts in series</i>	<i>Off or change-over switch</i>	<i>Voltage (V) AC / DC</i>		<i>Current (A)</i>
DC-23A	1	ON - OFF	60	DC	10
DC-23A	1	ON - OFF	110	DC	1,50
DC-23A	1	ON - OFF	220	DC	0,20
DC-23A	2	ON - OFF	48	DC	13
DC-23A	2	ON - OFF	96	DC	12
DC-23A	2	ON - OFF	120	DC	10
DC-23A	2	ON - OFF	220	DC	1,50
DC-23A	2	ON - OFF	440	DC	0,20
DC-23A	3	ON - OFF	72	DC	13
DC-23A	3	ON - OFF	144	DC	12
DC-23A	3	ON - OFF	180	DC	10
DC-23A	3	ON - OFF	330	DC	1,50
DC-23A	3	ON - OFF	660	DC	0,20
DC-23A	4	ON - OFF	96	DC	13
DC-23A	4	ON - OFF	192	DC	12
DC-23A	4	ON - OFF	240	DC	10
DC-23A	4	ON - OFF	440	DC	1,50
DC-23A	5	ON - OFF	120	DC	13
DC-23A	5	ON - OFF	240	DC	12
DC-23A	5	ON - OFF	300	DC	10
DC-23A	5	ON - OFF	550	DC	1,50
DC-23A	6	ON - OFF	144	DC	13
DC-23A	6	ON - OFF	288	DC	12
DC-23A	6	ON - OFF	360	DC	10
DC-23A	6	ON - OFF	660	DC	1,50
DC-23A	8	ON - OFF	192	DC	13
DC-23A	8	ON - OFF	384	DC	12
DC-23A	8	ON - OFF	480	DC	10
<b>Rated conditional short-circuit current</b>					
	<i>Current (kA)</i>	<i>Text</i>	<i>cut-off current I<sub>c</sub> (kA)</i>		<i>Durchlassenergie I<sup>2</sup>t (kA<sup>2</sup>s)</i>
	2	--	1,51		1,67
<b>Rated breaking capacity</b>					
	<i>Voltage (V)</i>	<i>Current (A)</i>	<i>Utilization category / UL (DOL)</i>		
	220 - 240	130	--		
	380 - 440	130	--		
	660 - 690	80	--		
<b>Rated short-circuit making capacity I<sub>cm</sub></b>					
					<i>Current (A)</i>
					450
<b>UL60947-4-1 , UL508</b>					
<b>Nominal Voltage</b>					
	<i>Voltage (V) AC / DC</i>				
	300 AC / DC				
<b>Rated insulation voltage U<sub>i</sub></b>					
	<i>Voltage (V) AC / DC</i>				
	300 AC				
<b>Rated thermal current</b>					
	<i>Current (A)</i>	<i>Ambient temperature (°C)</i>		<i>Additional Text</i>	
	20	0 - 40		--	
<b>Horsepower rating</b>					
<i>Across-the-Line Motor Starting</i>			<i>Voltage (V)</i>	<i>No. of phases</i>	<i>No. of poles</i>
Reversing			110 - 120	1	2
Reversing			220 - 240	1	2
Reversing			277 - 277	1	2
Reversing			110 - 120	3	3
Reversing			220 - 240	3	3
DOL			110 - 120	1	2
DOL			220 - 240	1	2
DOL			277 - 277	1	2
DOL			110 - 120	3	3
DOL			220 - 240	3	3
<b>Pilot duty rating code</b>					
<i>Duty Code</i>					
A300					
<b>SCCR / Max. fuse rating</b>					
<i>Conditions of acceptability</i>					
These devices are suitable for use on circuits capable of delivering not more than 5000 rms symmetrical amperes, 600V ac max. when protected by Class RK1 fuses. Manual Motor Controllers when intended for use as a motor disconnecter are suitable for use on a circuit capable of delivering not more than 5000 rms symmetrical amperes, 600V ac max. when protected by 30A Class J time delay fuses.					
<b>Temp. rating of wire</b>					
	<i>Temperature rating (°C)</i>		<i>Current (A) Text</i>		
	60 - 75		-- --		
<b>Connecting instructions</b>					
<i>Markings</i>					
When intended for use as a motor disconnecter the device shall be provided with a method of being locked in the OFF-position.					
<b>General Use</b>					
<i>AC / DC</i>	<i>Voltage (V)</i>	<i>Current (A)</i>	<i>No. of phases</i>	<i>No. of poles</i>	<i>No. of contacts in series</i>
AC	300	20	1	2	1

General Use						
AC / DC	Voltage (V)	Current (A)	No. of phases	No. of poles	No. of contacts in series	
AC	300	20	3	3	1	
<b>Suitable as Motor disconnect</b>						
Yes/No						
Y						
<b>CSA</b>						
<b>Nominal Voltage</b>						
					Voltage (V) AC / DC	
					300 AC	
<b>Rated insulation voltage Ui</b>						
					Voltage (V) AC / DC	
					300 AC	
<b>Rated thermal current</b>						
		Current (A)	Ambient temperature (°C)		Additional Text	
		20	0 - 40		--	
<b>Horsepower rating</b>						
<i>Across-the-Line Motor Starting</i>					Power (HP)	
		Voltage (V)	No. of phases	No. of poles		
DOL		110 - 120	1	2	0,50	
DOL		220 - 240	1	2	1	
DOL		277 - 277	1	2	2	
DOL		110 - 120	3	3	1,50	
DOL		220 - 240	3	3	3	
<b>Pilot duty rating code</b>						
Duty Code						
A300						
<b>Temp. rating of wire</b>						
		Temperature rating (°C)	Current (A)		Text	
		75			-- only	
<b>General Use</b>						
AC / DC	Voltage (V)	Current (A)	No. of phases	No. of poles	No. of contacts in series	
AC	300	20	1	1	1	
<b>MASTER DATA</b>						
<b>Max. number of stages</b>						
					number of stages Modul	
					12 FL	
<b>Switch Measures</b>						
Picture name	B	F	H	H1	H2	H3
	43	--	--	--	--	--
<b>GENERAL TECHNICAL INFORMATION</b>						
<b>Tightening torque of screws</b>						
				tightening torque (Nm)	tightening torque (lb-in)	
				0,60	5	
<b>Tested AC and DC values</b>						
Utilization category / Time constant	No. of contacts in series	Off or change-over switch	Voltage (V) AC / DC		Current (A)	
Ts1ms	1	ON - OFF	24 DC		20	
Ts1ms	1	ON - OFF	48 DC		12	
Ts1ms	1	ON - OFF	60 DC		4,50	
Ts1ms	1	ON - OFF	110 DC		1	
Ts1ms	1	ON - OFF	220 DC		0,40	
Ts1ms	1	ON - OFF	440 DC		0,27	
Ts1ms	2	ON - OFF	48 DC		20	
Ts1ms	2	ON - OFF	95 DC		12	
Ts1ms	2	ON - OFF	120 DC		4,50	
Ts1ms	2	ON - OFF	220 DC		1	
Ts1ms	2	ON - OFF	440 DC		0,40	
Ts1ms	2	ON - OFF	660 DC		0,27	
Ts1ms	3	ON - OFF	70 DC		20	
Ts1ms	3	ON - OFF	140 DC		12	
Ts1ms	3	ON - OFF	180 DC		4,50	
Ts1ms	3	ON - OFF	330 DC		1	
Ts1ms	3	ON - OFF	660 DC		0,40	
Ts1ms	4	ON - OFF	95 DC		20	
Ts1ms	4	ON - OFF	190 DC		12	
Ts1ms	4	ON - OFF	240 DC		4,50	
Ts1ms	4	ON - OFF	440 DC		1	
Ts1ms	5	ON - OFF	120 DC		20	
Ts1ms	5	ON - OFF	240 DC		12	
Ts1ms	5	ON - OFF	300 DC		4,50	
Ts1ms	5	ON - OFF	550 DC		1	
Ts1ms	6	ON - OFF	145 DC		20	
Ts1ms	6	ON - OFF	290 DC		12	
Ts1ms	6	ON - OFF	360 DC		4,50	
Ts1ms	6	ON - OFF	660 DC		1	

<b>Tested AC and DC values</b>					
<i>Utilization category / Time constant</i>	<i>No. of contacts in series</i>	<i>Off or change-over switch</i>	<i>Voltage (V) AC / DC</i>		<i>Current (A)</i>
T≤1ms	8	ON - OFF	190	DC	20
T≤1ms	8	ON - OFF	350	DC	12
T≤1ms	8	ON - OFF	450	DC	4,50
T=50ms	1	ON - OFF	24	DC	12
T=50ms	1	ON - OFF	30	DC	5
T=50ms	1	ON - OFF	48	DC	2
T=50ms	1	ON - OFF	60	DC	1
T=50ms	1	ON - OFF	110	DC	0,40
T=50ms	2	ON - OFF	48	DC	12
T=50ms	2	ON - OFF	60	DC	5
T=50ms	2	ON - OFF	95	DC	2
T=50ms	2	ON - OFF	120	DC	1
T=50ms	2	ON - OFF	220	DC	0,40
T=50ms	3	ON - OFF	70	DC	12
T=50ms	3	ON - OFF	90	DC	5
T=50ms	3	ON - OFF	140	DC	2
T=50ms	3	ON - OFF	180	DC	1
T=50ms	3	ON - OFF	330	DC	0,40
T=50ms	4	ON - OFF	95	DC	12
T=50ms	4	ON - OFF	120	DC	5
T=50ms	4	ON - OFF	190	DC	2
T=50ms	4	ON - OFF	240	DC	1
T=50ms	4	ON - OFF	440	DC	0,40
T=50ms	5	ON - OFF	120	DC	12
T=50ms	5	ON - OFF	150	DC	5
T=50ms	5	ON - OFF	240	DC	2
T=50ms	5	ON - OFF	300	DC	1
T=50ms	5	ON - OFF	550	DC	0,40
T=50ms	6	ON - OFF	145	DC	12
T=50ms	6	ON - OFF	180	DC	5
T=50ms	6	ON - OFF	290	DC	2
T=50ms	6	ON - OFF	360	DC	1
T=50ms	6	ON - OFF	660	DC	0,40
T=50ms	8	ON - OFF	190	DC	12
T=50ms	8	ON - OFF	240	DC	5
T=50ms	8	ON - OFF	350	DC	2
T=50ms	8	ON - OFF	450	DC	1
<b>Stripping length</b>					
<i>Length (mm) –</i>					
8 STRIPPINGLENGTH					
<b>Minimal ratings (voltage/current)</b>					
<i>Voltage (V)</i>	<i>Current (mA)</i>	<i>Environment conditions</i>	<i>Environment conditions 2</i>	<i>Environment conditions 3</i>	
20	5	Ambient air must be free of particular contamination with sulfur and/or sulfurous components such as H2S etc.	In case extraordinary contamination with dust is expected an adequate dust protection is required.	--	
<b>Rated short-time withstand current Icw</b>					
<i>Time (s)</i>					<i>Current (A)</i>
1					140
<b>Size of conductor</b>					
<i>composition of conductor</i>	<i>Min. / Max. value</i>	<i>No. of conductor per terminal</i>	<i>Cross section (mm<sup>2</sup>) or (AWG/kcmil)</i>		<i>Material of the wire</i>
solid wire	Min.	1	0.5mm <sup>2</sup>		Copper
solid wire	Min.	2	0.5mm <sup>2</sup>		Copper
flexible wire	Min.	1	0.75mm <sup>2</sup>		Copper
flexible wire	Min.	2	0.75mm <sup>2</sup>		Copper
flexible wire	Max.	2	2.5mm <sup>2</sup>		Copper
flexible wire	Max.	2	AWG 14		Copper
Single-core or stranded wire	Max.	2	AWG 12		Copper
Single-core or stranded wire	Max.	2	2.5mm <sup>2</sup>		Copper
flexible wire with ferrule according to DIN 46228	Max.	2	2.5mm <sup>2</sup>		Copper
flexible wire with ferrule according to DIN 46228	Min.	1	0.5mm <sup>2</sup>		Copper
flexible wire with ferrule according to DIN 46228	Min.	2	0.5mm <sup>2</sup>		Copper
<b>Approbations</b>					
<i>Specification</i>					<i>Marking</i>
EAC					
CE marking					
UK Directives					
Lloyd's Register EMEA					
IEC 60947-3; EN 60947-3; VDE 0660 Teil107					<b>IEC 60947-3</b> <b>EN 60947-3</b>

Approbations									
Specification									Marking
UL 60947-4-1; CSA C22.2 No. 60947-4-1									
CSA C.22.2 No.14									
GB/T14048.3									
Russian Maritime Register of Shipping									
Power loss per pole									Power (W)
									0,90
Mechanical life									
No. of operations		Ambient temperature (°C)			Number of stages		Limitations		
1000000		-5 - 55					Valid for manual operation. Valid for switches without optional extras. The value refers to the mechanics of the device, for lifetime of the electrical contacts please refer to "electrical life - values".		
150000		-25 - 55					Valid for manual operation. Valid for switches without optional extras. The value refers to the mechanics of the device, for lifetime of the electrical contacts please refer to "electrical life 5 values".		
Electrical life (B10-Value)									
Utilization category	cos(φ)	Time constant (ms)	Voltage (V)	Current (A)	No. of operations	number of series contacts	AC/DC	No. of phases	No. of poles
--	0,56	--	119	15	100000	1	AC	1	1
--	0,59	--	122	10	150000	1	AC	1	1
--	0,59	--	220	5	900000	1	AC	1	1
--	0,59	--	220	10	100000	1	AC	1	1
--	0,95	--	220	10	125000	1	AC	1	1
--	0,59	--	220	15	35000	1	AC	1	1
--	0,64	--	220	20	25000	1	AC	1	1
--	0,65	--	380	5	300000	1	AC	1	1
--	0,64	--	380	10	90000	1	AC	1	1
--	0,64	--	380	15	40000	1	AC	1	1
AC-3	--	--	440	11,50	100000	1	AC	3	3
AC-23	--	--	440	15,50	30000	1	AC	3	3
AC-3	--	--	690	6,80	100000	1	AC	3	3
AC-23	--	--	690	9	80000	1	AC	3	3
AC-22	--	--	690	20	40000	1	AC	3	3
--	--	1	24	20	80000	1	DC	1	1
--	--	1	48	12	75000	1	DC	1	1
--	--	1	60	4,50	200000	1	DC	1	1
--	--	1	110	2	100000	1	DC	1	1
--	--	1	220	0,50	100000	1	DC	1	1
--	--	1,20	440	0,28	200000	1	DC	1	1
--	--	50	24	0,50	200000	1	DC	1	1
--	--	50	24	1	100000	1	DC	1	1
--	--	50	24	12	8000	1	DC	1	1
--	--	50	30	5	20000	1	DC	1	1
--	--	50	48	1	75000	1	DC	1	1
--	--	50	48	3	50000	1	DC	1	1
--	--	50	60	2	30000	1	DC	1	1
--	--	50	110	0,40	80000	1	DC	1	1
--	--	50	110	0,50	80000	1	DC	1	1
--	--	51	60	1	50000	1	DC	1	1
--	--	52	110	0,10	200000	1	DC	1	1
--	--	55	110	1	50000	1	DC	1	1
--	--	55	110	1,50	25000	1	DC	1	1
--	--	55	220	0,50	40000	1	DC	1	1
--	--	100	110	0,50	50000	1	DC	1	1
--	--	100	110	1	25000	1	DC	1	1
Recommended screw driver									
Type of screw driver					Value				
Cross Screwdriver					PH1				
Flat blade					0,8x4				
Degree of protection									
IP - Code switch terminal									
IP20									
Conditions during transport and storing									
Minimum temperature (°C)					Maximum temperature (°C) additional requirements				
-40					85 In case of temperatures below -5°C no shock load permissible				
Shock / Vibration									
Type of oscillation					Values				
Resistance to vibration					Min. 4g, 2-100Hz, 1,6mm				

Shock / Vibration	
Type of oscillation	Values
Resistance to shock	Min. 5g, 6ms
Resistance to vibration	IEC 61373 (1999) Category 1, Class B
Resistance to shock	min. 5g, 30ms
General Information	
Text	
<ul style="list-style-type: none"> <li>- DC switching capacity applies to ON/OFF switches.</li> <li>- Do not lubricate or treat contacts.</li> <li>- Switches may only be mounted, connected and set into operation by qualified persons according to the accepted rules of technology.</li> <li>- Use copper wire only. Do not coat the wire end with tin.</li> <li>- Terminals with factory fitted jumper links are tightened during production. Take care during installation to ensure factory fitted links are not lost by undoing both sides of linked terminals. After wiring, all terminal screws must be tightened to recommended torque specifications.</li> <li>- After installation of the switches the spacings between the terminals must be sufficient to fulfill the requirement of the applicable standards.</li> </ul>	
<b>Creepage distance</b>	
	Distance (mm)
	9,50
<b>Clearance</b>	
	Distance (mm)
	6,35
<b>Distance of stages</b>	
	Distance (mm)
	9,50
<b>Operating temperature</b>	
	Min. Temperature [°C]
	-25
	Max. Temperature [°C]
	60
Waste Electrical & Electronic Equipment (WEEE)	
Picture name	Description
	
<p>Do not throw in the trash as care must be taken to ensure environmentally sound disposal and recycling. Please either use an environmentally friendly waste disposal company; return to the supplier for disposal; or return direct to the manufacturer, Kraus &amp; Naimer. You can find local Kraus &amp; Naimer offices at <a href="http://www.krausnaimer.com">www.krausnaimer.com</a></p>	
Proposition 65	
Picture name	Description
	
<p>WARNING: This product can expose you to chemicals including nickel and lead, which is known to the State of California to cause cancer. For more information go to <a href="http://www.P65Warnings.ca.gov">www.P65Warnings.ca.gov</a>.</p>	

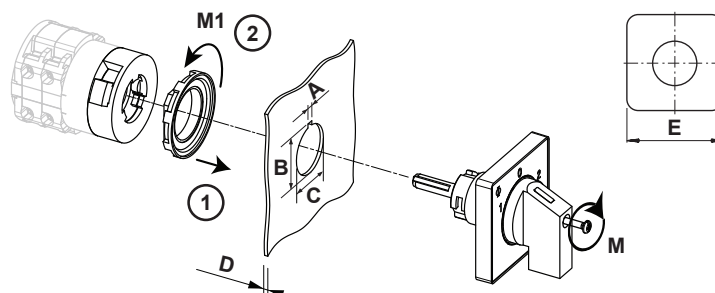
Mounting-FT2			
			
IP - Code front side		IP66, IP67, IP69k	
Stages		1,00 - 12,00	
A	H	3,20 mm	
A+_tol.	H	0,20 mm	
A-_tol.	H	0,00 mm	
B	H	24,10 mm	
B+_tol.	H	0,40 mm	
B-_tol.	H	0,00 mm	
C	Ø	22,30 mm	
C+_tol.	Ø	0,40 mm	
C-_tol.	Ø	0,00 mm	
D	H	<= 6,00 mm	
E	□	48,00 mm	

M	$\vec{M}$	0,50 Nm
M1	$\vec{M}$	1,80 Nm



**Wiring diagram**

CA10.A213.FT2

 Kraus & Naimer

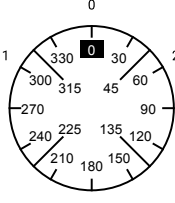
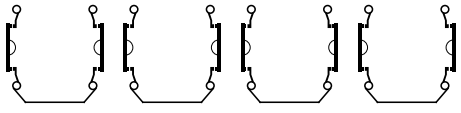
		CA10				A213				Page 1 of 1			
<b>Face Plate</b>													
		1	3	5	7	9	11	13	15	17	19	21	23
													
Switching Angle <input type="text" value="60"/> Total switching Angle <input type="text" value="120"/>		2	4	6	8	10	12	14	16	18	20	22	24
1			■		■		■		■				
300													
315													
330													
345													
0													
0													
15													
30													
45													
2		■		■		■		■					
60													
75													
90													
105													
120													
135													
150													
165													
180													
195													
210													
225													
240													
255													
270													
285													

Version: 93

**Face plate**

S0.F071/A10.E1L

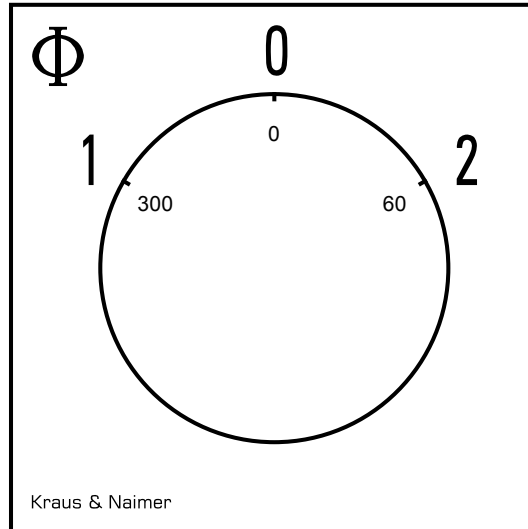

## HANDLES

**Designation:** S0C.G251  
**Handle colour:** "1" black

