



Sample image

## Datasheet

**Article number:** 70002178  
**Designation:** CA10.A210.FT2  
**Description:** Schalter  
**Contact development:** A210  
**Face plate engraving:** F071  
**Type of mounting:** FT2





Type Size: S0
Classification Contact: Rigid contact bridge
Classification Contact Mat: Silver
Classification Terminal: Screw terminal

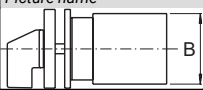

IEC 60947-3 EN 60947-3, VDE 0660 Teil 107						
<b>Rated insulation voltage U<sub>i</sub></b>						
		Voltage (V) AC / DC				
		690 AC / DC				
<b>Rated impulse withstand voltage U<sub>imp</sub></b>						
Voltage (kV)	Overvoltage category	Pollution degree	Supply system	Function		
6 III		3	Valid for lines with grounded common neutral termination	switch		
4 III		3	Valid for lines with grounded common neutral termination	Switch disconnecter		
<b>Rated uninterrupted current I<sub>u</sub>/I<sub>th</sub></b>						
Current (A)	Ambient temperature (°C)	Peak temperature (°C)	additional requirements			
20	55	60	Ambient temperature +55°C during 24 hours with peaks up to +60°C			
<b>Conventional enclosed thermal current I<sub>thc</sub></b>						
Current (A)	Ambient temperature (°C)	Peak temperature (°C)	Additional requirements	No. of stages (from - to)	Mounting	Mounting size
20	35	40	Ambient temperature +35°C during 24 hours with peaks up to +40°C	--	--	--
<b>Rated operational current I<sub>e</sub></b>						
Utilization category				Voltage (V)	Current (A)	
AC-15				220 - 240	6	
AC-15				380 - 440	4	
AC-20A				690	20	
AC-21A				20 - 690	20	
AC-22A				220 - 500	20	
AC-22A				660 - 690	20	
<b>Rated operational power</b>						
Utilization category	Voltage (V)	No. of phases	No. of poles		Power (kW)	
AC-6b	380 - 400	3	3		--	
AC-6b	220 - 230	1	2		--	
AC-2	220 - 240	3	3		4	
AC-2	380 - 440	3	3		7,50	
AC-2	500 - 500	3	3		10	
AC-2	660 - 690	3	3		10	
AC-3	220 - 240	3	3		3	
AC-3	380 - 440	3	3		5,50	
AC-3	500 - 500	3	3		5,50	
AC-3	660 - 690	3	3		5,50	
AC-3	110 - 120	1	2		0,60	
AC-3	220 - 240	1	2		2,20	
AC-3	380 - 440	1	2		3	
AC-4	220 - 240	3	3		0,55	
AC-4	380 - 440	3	3		1,50	
AC-4	500 - 500	3	3		1,50	
AC-4	660 - 690	3	3		1,50	
AC-4	110 - 120	1	2		0,30	
AC-4	220 - 240	1	2		0,75	
AC-4	380 - 440	1	2		1,50	
AC-23A	220 - 240	3	3		3,70	
AC-23A	380 - 440	3	3		7,50	
AC-23A	500 - 500	3	3		7,50	
AC-23A	660 - 690	3	3		7,50	
AC-23A	110 - 120	1	2		0,75	
AC-23A	220 - 240	1	2		2,50	
AC-23A	380 - 440	1	2		3,70	



<b>Max Fuse Rating IEC</b>					
Fuse characteristic		No. of Fuses		Current (A)	
gG		1		25	
<b>Tested AC and DC values</b>					
Utilization category / Time constant	No. of contacts in series	Off or change-over switch	Voltage (V)	AC / DC	Current (A)
DC-13	1	ON - OFF	24	DC	3
DC-13	1	ON - OFF	48	DC	1,70
DC-13	1	ON - OFF	60	DC	1,40
DC-13	1	ON - OFF	110	DC	0,70
DC-13	1	ON - OFF	220	DC	0,15
DC-13	2	ON - OFF	24	DC	6
DC-13	2	ON - OFF	48	DC	3
DC-13	2	ON - OFF	96	DC	1,70
DC-13	2	ON - OFF	120	DC	1,40
DC-13	2	ON - OFF	220	DC	0,70
DC-13	2	ON - OFF	440	DC	0,15
DC-21A	1	ON - OFF	24	DC	20
DC-21A	1	ON - OFF	48	DC	20
DC-21A	1	ON - OFF	60	DC	20
DC-21A	1	ON - OFF	110	DC	6
DC-21A	1	ON - OFF	220	DC	0,90
DC-21A	2	ON - OFF	48	DC	16
DC-21A	2	ON - OFF	96	DC	14
DC-21A	2	ON - OFF	120	DC	13
DC-21A	2	ON - OFF	220	DC	6
DC-21A	2	ON - OFF	440	DC	0,90
DC-21A	3	ON - OFF	72	DC	16
DC-21A	3	ON - OFF	144	DC	14
DC-21A	3	ON - OFF	180	DC	13
DC-21A	3	ON - OFF	330	DC	6
DC-21A	3	ON - OFF	660	DC	0,90
DC-21A	4	ON - OFF	96	DC	16
DC-21A	4	ON - OFF	192	DC	14
DC-21A	4	ON - OFF	240	DC	13
DC-21A	4	ON - OFF	440	DC	6
DC-21A	5	ON - OFF	120	DC	16
DC-21A	5	ON - OFF	240	DC	14
DC-21A	5	ON - OFF	300	DC	13
DC-21A	5	ON - OFF	550	DC	6
DC-21A	6	ON - OFF	144	DC	16
DC-21A	6	ON - OFF	288	DC	14
DC-21A	6	ON - OFF	360	DC	13
DC-21A	6	ON - OFF	660	DC	6
DC-21A	8	ON - OFF	192	DC	16
DC-21A	8	ON - OFF	384	DC	14
DC-21A	8	ON - OFF	480	DC	13
DC-22A	1	ON - OFF	24	DC	20
DC-22A	1	ON - OFF	48	DC	20
DC-22A	1	ON - OFF	60	DC	12
DC-22A	1	ON - OFF	110	DC	1,90
DC-22A	1	ON - OFF	220	DC	0,30
DC-22A	2	ON - OFF	48	DC	14
DC-22A	2	ON - OFF	96	DC	13
DC-22A	2	ON - OFF	120	DC	12
DC-22A	2	ON - OFF	220	DC	1,90
DC-22A	2	ON - OFF	440	DC	0,30
DC-22A	3	ON - OFF	72	DC	14
DC-22A	3	ON - OFF	144	DC	13
DC-22A	3	ON - OFF	180	DC	12
DC-22A	3	ON - OFF	330	DC	1,90
DC-22A	3	ON - OFF	660	DC	0,30
DC-22A	4	ON - OFF	96	DC	14
DC-22A	4	ON - OFF	192	DC	13
DC-22A	4	ON - OFF	240	DC	12
DC-22A	4	ON - OFF	440	DC	1,90
DC-22A	5	ON - OFF	120	DC	14
DC-22A	5	ON - OFF	240	DC	13
DC-22A	5	ON - OFF	300	DC	12
DC-22A	5	ON - OFF	550	DC	1,90
DC-22A	6	ON - OFF	144	DC	14
DC-22A	6	ON - OFF	288	DC	13
DC-22A	6	ON - OFF	360	DC	12
DC-22A	6	ON - OFF	660	DC	1,90
DC-22A	8	ON - OFF	192	DC	14
DC-22A	8	ON - OFF	384	DC	13
DC-22A	8	ON - OFF	480	DC	12
DC-23A	1	ON - OFF	24	DC	20
DC-23A	1	ON - OFF	48	DC	20

<b>Tested AC and DC values</b>					
<i>Utilization category / Time constant</i>	<i>No. of contacts in series</i>	<i>Off or change-over switch</i>	<i>Voltage (V) AC / DC</i>		<i>Current (A)</i>
DC-23A	1	ON - OFF	60	DC	10
DC-23A	1	ON - OFF	110	DC	1,50
DC-23A	1	ON - OFF	220	DC	0,20
DC-23A	2	ON - OFF	48	DC	13
DC-23A	2	ON - OFF	96	DC	12
DC-23A	2	ON - OFF	120	DC	10
DC-23A	2	ON - OFF	220	DC	1,50
DC-23A	2	ON - OFF	440	DC	0,20
DC-23A	3	ON - OFF	72	DC	13
DC-23A	3	ON - OFF	144	DC	12
DC-23A	3	ON - OFF	180	DC	10
DC-23A	3	ON - OFF	330	DC	1,50
DC-23A	3	ON - OFF	660	DC	0,20
DC-23A	4	ON - OFF	96	DC	13
DC-23A	4	ON - OFF	192	DC	12
DC-23A	4	ON - OFF	240	DC	10
DC-23A	4	ON - OFF	440	DC	1,50
DC-23A	5	ON - OFF	120	DC	13
DC-23A	5	ON - OFF	240	DC	12
DC-23A	5	ON - OFF	300	DC	10
DC-23A	5	ON - OFF	550	DC	1,50
DC-23A	6	ON - OFF	144	DC	13
DC-23A	6	ON - OFF	288	DC	12
DC-23A	6	ON - OFF	360	DC	10
DC-23A	6	ON - OFF	660	DC	1,50
DC-23A	8	ON - OFF	192	DC	13
DC-23A	8	ON - OFF	384	DC	12
DC-23A	8	ON - OFF	480	DC	10
<b>Rated conditional short-circuit current</b>					
	<i>Current (kA)</i>	<i>Text</i>	<i>cut-off current I<sub>c</sub> (kA)</i>		<i>Durchlassenergie I<sup>2</sup>t (kA<sup>2</sup>s)</i>
	2	--	1,51		1,67
<b>Rated breaking capacity</b>					
	<i>Voltage (V)</i>	<i>Current (A)</i>	<i>Utilization category / UL (DOL)</i>		
	220 - 240	130	--		
	380 - 440	130	--		
	660 - 690	80	--		
<b>Rated short-circuit making capacity I<sub>cm</sub></b>					
					<i>Current (A)</i>
					450
<b>UL60947-4-1 , UL508</b>					
<b>Nominal Voltage</b>					
	<i>Voltage (V) AC / DC</i>				
	300 AC / DC				
<b>Rated insulation voltage U<sub>i</sub></b>					
	<i>Voltage (V) AC / DC</i>				
	300 AC				
<b>Rated thermal current</b>					
	<i>Current (A)</i>	<i>Ambient temperature (°C)</i>		<i>Additional Text</i>	
	20	0 - 40		--	
<b>Horsepower rating</b>					
<i>Across-the-Line Motor Starting</i>			<i>Voltage (V)</i>	<i>No. of phases</i>	<i>No. of poles</i>
Reversing			110 - 120	1	2
Reversing			220 - 240	1	2
Reversing			277 - 277	1	2
Reversing			110 - 120	3	3
Reversing			220 - 240	3	3
DOL			110 - 120	1	2
DOL			220 - 240	1	2
DOL			277 - 277	1	2
DOL			110 - 120	3	3
DOL			220 - 240	3	3
<b>Pilot duty rating code</b>					
<i>Duty Code</i>					
A300					
<b>SCCR / Max. fuse rating</b>					
<i>Conditions of acceptability</i>					
These devices are suitable for use on circuits capable of delivering not more than 5000 rms symmetrical amperes, 600V ac max. when protected by Class RK1 fuses. Manual Motor Controllers when intended for use as a motor disconnecter are suitable for use on a circuit capable of delivering not more than 5000 rms symmetrical amperes, 600V ac max. when protected by 30A Class J time delay fuses.					
<b>Temp. rating of wire</b>					
	<i>Temperature rating (°C)</i>		<i>Current (A) Text</i>		
	60 - 75		-- --		
<b>Connecting instructions</b>					
<i>Markings</i>					
When intended for use as a motor disconnecter the device shall be provided with a method of being locked in the OFF-position.					
<b>General Use</b>					
<i>AC / DC</i>	<i>Voltage (V)</i>	<i>Current (A)</i>	<i>No. of phases</i>	<i>No. of poles</i>	<i>No. of contacts in series</i>
AC	300	20	1	2	1

General Use							
AC / DC	Voltage (V)	Current (A)	No. of phases	No. of poles	No. of contacts in series		
AC	300	20	3	3	1		
<b>Suitable as Motor disconnect</b>							
Yes/No							
Y							
<b>CSA</b>							
<b>Nominal Voltage</b>							
			Voltage (V) AC / DC				
			300 AC				
<b>Rated insulation voltage Ui</b>							
			Voltage (V) AC / DC				
			300 AC				
<b>Rated thermal current</b>							
		Current (A)	Ambient temperature (°C)		Additional Text		
		20	0 - 40		--		
<b>Horsepower rating</b>							
<i>Across-the-Line Motor Starting</i>				Voltage (V)	No. of phases	No. of poles	Power (HP)
DOL				110 - 120	1	2	0,50
DOL				220 - 240	1	2	1
DOL				277 - 277	1	2	2
DOL				110 - 120	3	3	1,50
DOL				220 - 240	3	3	3
<b>Pilot duty rating code</b>							
Duty Code							
A300							
<b>Temp. rating of wire</b>							
			Temperature rating (°C)	Current (A)	Text		
			75	--	only		
<b>General Use</b>							
AC / DC	Voltage (V)	Current (A)	No. of phases	No. of poles	No. of contacts in series		
AC	300	20	1	1	1		
<b>MASTER DATA</b>							
<b>Max. number of stages</b>							
			number of stages Modul				
			12 FL				
<b>Switch Measures</b>							
Picture name	B	F	H	H1	H2	H3	
	43	--	--	--	--	--	
<b>GENERAL TECHNICAL INFORMATION</b>							
<b>Tightening torque of screws</b>							
			tightening torque (Nm)	tightening torque (lb-in)			
			0,60	5			
<b>Tested AC and DC values</b>							
Utilization category / Time constant	No. of contacts in series	Off or change-over switch	Voltage (V)	AC / DC	Current (A)		
Ts1ms	1	ON - OFF	24	DC	20		
Ts1ms	1	ON - OFF	48	DC	12		
Ts1ms	1	ON - OFF	60	DC	4,50		
Ts1ms	1	ON - OFF	110	DC	1		
Ts1ms	1	ON - OFF	220	DC	0,40		
Ts1ms	1	ON - OFF	440	DC	0,27		
Ts1ms	2	ON - OFF	48	DC	20		
Ts1ms	2	ON - OFF	95	DC	12		
Ts1ms	2	ON - OFF	120	DC	4,50		
Ts1ms	2	ON - OFF	220	DC	1		
Ts1ms	2	ON - OFF	440	DC	0,40		
Ts1ms	2	ON - OFF	660	DC	0,27		
Ts1ms	3	ON - OFF	70	DC	20		
Ts1ms	3	ON - OFF	140	DC	12		
Ts1ms	3	ON - OFF	180	DC	4,50		
Ts1ms	3	ON - OFF	330	DC	1		
Ts1ms	3	ON - OFF	660	DC	0,40		
Ts1ms	4	ON - OFF	95	DC	20		
Ts1ms	4	ON - OFF	190	DC	12		
Ts1ms	4	ON - OFF	240	DC	4,50		
Ts1ms	4	ON - OFF	440	DC	1		
Ts1ms	5	ON - OFF	120	DC	20		
Ts1ms	5	ON - OFF	240	DC	12		
Ts1ms	5	ON - OFF	300	DC	4,50		
Ts1ms	5	ON - OFF	550	DC	1		
Ts1ms	6	ON - OFF	145	DC	20		
Ts1ms	6	ON - OFF	290	DC	12		
Ts1ms	6	ON - OFF	360	DC	4,50		
Ts1ms	6	ON - OFF	660	DC	1		

<b>Tested AC and DC values</b>					
<i>Utilization category / Time constant</i>	<i>No. of contacts in series</i>	<i>Off or change-over switch</i>	<i>Voltage (V) AC / DC</i>		<i>Current (A)</i>
T≤1ms	8	ON - OFF	190	DC	20
T≤1ms	8	ON - OFF	350	DC	12
T≤1ms	8	ON - OFF	450	DC	4,50
T=50ms	1	ON - OFF	24	DC	12
T=50ms	1	ON - OFF	30	DC	5
T=50ms	1	ON - OFF	48	DC	2
T=50ms	1	ON - OFF	60	DC	1
T=50ms	1	ON - OFF	110	DC	0,40
T=50ms	2	ON - OFF	48	DC	12
T=50ms	2	ON - OFF	60	DC	5
T=50ms	2	ON - OFF	95	DC	2
T=50ms	2	ON - OFF	120	DC	1
T=50ms	2	ON - OFF	220	DC	0,40
T=50ms	3	ON - OFF	70	DC	12
T=50ms	3	ON - OFF	90	DC	5
T=50ms	3	ON - OFF	140	DC	2
T=50ms	3	ON - OFF	180	DC	1
T=50ms	3	ON - OFF	330	DC	0,40
T=50ms	4	ON - OFF	95	DC	12
T=50ms	4	ON - OFF	120	DC	5
T=50ms	4	ON - OFF	190	DC	2
T=50ms	4	ON - OFF	240	DC	1
T=50ms	4	ON - OFF	440	DC	0,40
T=50ms	5	ON - OFF	120	DC	12
T=50ms	5	ON - OFF	150	DC	5
T=50ms	5	ON - OFF	240	DC	2
T=50ms	5	ON - OFF	300	DC	1
T=50ms	5	ON - OFF	550	DC	0,40
T=50ms	6	ON - OFF	145	DC	12
T=50ms	6	ON - OFF	180	DC	5
T=50ms	6	ON - OFF	290	DC	2
T=50ms	6	ON - OFF	360	DC	1
T=50ms	6	ON - OFF	660	DC	0,40
T=50ms	8	ON - OFF	190	DC	12
T=50ms	8	ON - OFF	240	DC	5
T=50ms	8	ON - OFF	350	DC	2
T=50ms	8	ON - OFF	450	DC	1
<b>Stripping length</b>					
<i>Length (mm) –</i>					
8 STRIPPINGLENGTH					
<b>Minimal ratings (voltage/current)</b>					
<i>Voltage (V)</i>	<i>Current (mA)</i>	<i>Environment conditions</i>	<i>Environment conditions 2</i>	<i>Environment conditions 3</i>	
20	5	Ambient air must be free of particular contamination with sulfur and/or sulfurous components such as H2S etc.	In case extraordinary contamination with dust is expected an adequate dust protection is required.	--	
<b>Rated short-time withstand current Icw</b>					
<i>Time (s)</i>					<i>Current (A)</i>
1					140
<b>Size of conductor</b>					
<i>composition of conductor</i>	<i>Min. / Max. value</i>	<i>No. of conductor per terminal</i>	<i>Cross section (mm<sup>2</sup>) or (AWG/kcmil)</i>		<i>Material of the wire</i>
solid wire	Min.	1	0.5mm <sup>2</sup>		Copper
solid wire	Min.	2	0.5mm <sup>2</sup>		Copper
flexible wire	Min.	1	0.75mm <sup>2</sup>		Copper
flexible wire	Min.	2	0.75mm <sup>2</sup>		Copper
flexible wire	Max.	2	2.5mm <sup>2</sup>		Copper
flexible wire	Max.	2	AWG 14		Copper
Single-core or stranded wire	Max.	2	AWG 12		Copper
Single-core or stranded wire	Max.	2	2.5mm <sup>2</sup>		Copper
flexible wire with ferrule according to DIN 46228	Max.	2	2.5mm <sup>2</sup>		Copper
flexible wire with ferrule according to DIN 46228	Min.	1	0.5mm <sup>2</sup>		Copper
flexible wire with ferrule according to DIN 46228	Min.	2	0.5mm <sup>2</sup>		Copper
<b>Approbations</b>					
<i>Specification</i>					<i>Marking</i>
EAC					
CE marking					
UK Directives					
Lloyd's Register EMEA					
IEC 60947-3; EN 60947-3; VDE 0660 Teil107					<b>IEC 60947-3</b> <b>EN 60947-3</b>

Approbations									
Specification									Marking
UL 60947-4-1; CSA C22.2 No. 60947-4-1									
CSA C.22.2 No.14									
GB/T14048.3									
Russian Maritime Register of Shipping									
Power loss per pole									Power (W)
									0,90
Mechanical life									
No. of operations		Ambient temperature (°C)			Number of stages		Limitations		
1000000		-5 - 55					Valid for manual operation. Valid for switches without optional extras. The value refers to the mechanics of the device, for lifetime of the electrical contacts please refer to "electrical life - values".		
150000		-25 - 55					Valid for manual operation. Valid for switches without optional extras. The value refers to the mechanics of the device, for lifetime of the electrical contacts please refer to "electrical life 5 values".		
Electrical life (B10-Value)									
Utilization category	cos(φ)	Time constant (ms)	Voltage (V)	Current (A)	No. of operations	number of series contacts	AC/DC	No. of phases	No. of poles
--	0,56	--	119	15	100000	1	AC	1	1
--	0,59	--	122	10	150000	1	AC	1	1
--	0,59	--	220	5	900000	1	AC	1	1
--	0,59	--	220	10	100000	1	AC	1	1
--	0,95	--	220	10	125000	1	AC	1	1
--	0,59	--	220	15	35000	1	AC	1	1
--	0,64	--	220	20	25000	1	AC	1	1
--	0,65	--	380	5	300000	1	AC	1	1
--	0,64	--	380	10	90000	1	AC	1	1
--	0,64	--	380	15	40000	1	AC	1	1
AC-3	--	--	440	11,50	100000	1	AC	3	3
AC-23	--	--	440	15,50	30000	1	AC	3	3
AC-3	--	--	690	6,80	100000	1	AC	3	3
AC-23	--	--	690	9	80000	1	AC	3	3
AC-22	--	--	690	20	40000	1	AC	3	3
--	--	1	24	20	80000	1	DC	1	1
--	--	1	48	12	75000	1	DC	1	1
--	--	1	60	4,50	200000	1	DC	1	1
--	--	1	110	2	100000	1	DC	1	1
--	--	1	220	0,50	100000	1	DC	1	1
--	--	1,20	440	0,28	200000	1	DC	1	1
--	--	50	24	0,50	200000	1	DC	1	1
--	--	50	24	1	100000	1	DC	1	1
--	--	50	24	12	8000	1	DC	1	1
--	--	50	30	5	20000	1	DC	1	1
--	--	50	48	1	75000	1	DC	1	1
--	--	50	48	3	50000	1	DC	1	1
--	--	50	60	2	30000	1	DC	1	1
--	--	50	110	0,40	80000	1	DC	1	1
--	--	50	110	0,50	80000	1	DC	1	1
--	--	51	60	1	50000	1	DC	1	1
--	--	52	110	0,10	200000	1	DC	1	1
--	--	55	110	1	50000	1	DC	1	1
--	--	55	110	1,50	25000	1	DC	1	1
--	--	55	220	0,50	40000	1	DC	1	1
--	--	100	110	0,50	50000	1	DC	1	1
--	--	100	110	1	25000	1	DC	1	1
Recommended screw driver									
Type of screw driver					Value				
Cross Screwdriver					PH1				
Flat blade					0,8x4				
Degree of protection									
IP - Code switch terminal									
IP20									
Conditions during transport and storing									
Minimum temperature (°C)					Maximum temperature (°C) additional requirements				
-40					85 In case of temperatures below -5°C no shock load permissible				
Shock / Vibration									
Type of oscillation					Values				
Resistance to vibration					Min. 4g, 2-100Hz, 1,6mm				

Shock / Vibration	
Type of oscillation	Values
Resistance to shock	Min. 5g, 6ms
Resistance to vibration	IEC 61373 (1999) Category 1, Class B
Resistance to shock	min. 5g, 30ms
General Information	
Text	
<ul style="list-style-type: none"> <li>- DC switching capacity applies to ON/OFF switches.</li> <li>- Do not lubricate or treat contacts.</li> <li>- Switches may only be mounted, connected and set into operation by qualified persons according to the accepted rules of technology.</li> <li>- Use copper wire only. Do not coat the wire end with tin.</li> <li>- Terminals with factory fitted jumper links are tightened during production. Take care during installation to ensure factory fitted links are not lost by undoing both sides of linked terminals. After wiring, all terminal screws must be tightened to recommended torque specifications.</li> <li>- After installation of the switches the spacings between the terminals must be sufficient to fulfill the requirement of the applicable standards.</li> </ul>	
<b>Creepage distance</b>	
	Distance (mm)
	9,50
<b>Clearance</b>	
	Distance (mm)
	6,35
<b>Distance of stages</b>	
	Distance (mm)
	9,50
<b>Operating temperature</b>	
	Min. Temperature [°C]
	-25
	Max. Temperature [°C]
	60
Waste Electrical & Electronic Equipment (WEEE)	
Picture name	Description
	
<p>Do not throw in the trash as care must be taken to ensure environmentally sound disposal and recycling. Please either use an environmentally friendly waste disposal company; return to the supplier for disposal; or return direct to the manufacturer, Kraus &amp; Naimer. You can find local Kraus &amp; Naimer offices at <a href="http://www.krausnaimer.com">www.krausnaimer.com</a></p>	
Proposition 65	
Picture name	Description
	
<p>WARNING: This product can expose you to chemicals including nickel and lead, which is known to the State of California to cause cancer. For more information go to <a href="http://www.P65Warnings.ca.gov">www.P65Warnings.ca.gov</a>.</p>	

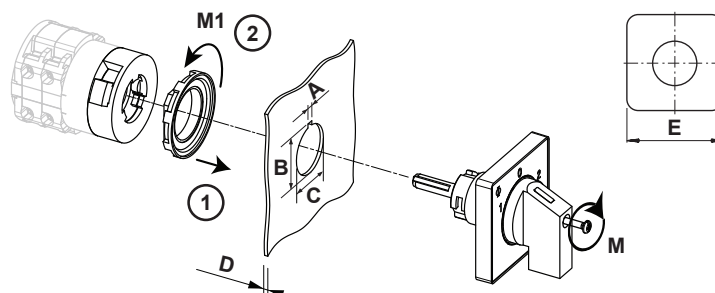
Mounting-FT2			
			
IP - Code front side		IP66, IP67, IP69k	
Stages		1,00 - 12,00	
A	H	3,20 mm	
A+_tol.	H	0,20 mm	
A-_tol.	H	0,00 mm	
B	H	24,10 mm	
B+_tol.	H	0,40 mm	
B-_tol.	H	0,00 mm	
C	Ø	22,30 mm	
C+_tol.	Ø	0,40 mm	
C-_tol.	Ø	0,00 mm	
D	H	<= 6,00 mm	
E	□	48,00 mm	

M	$\vec{M}$	0,50 Nm
M1	$\vec{M}$	1,80 Nm



**Wiring diagram**

CA10.A210.FT2

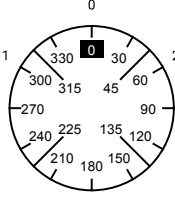
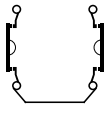
 Kraus & Naimer		<b>CA10</b>	<b>A210</b>	<b>Page 1 of 1</b>											
<b>Face Plate</b>															
		1	3	5	7	9	11	13	15	17	19	21	23		
															
Switching Angle <input type="text" value="60"/> Total switching Angle <input type="text" value="120"/>		2	4	6	8	10	12	14	16	18	20	22	24		
1	300														
	315														
	330														
	345														
0	0														
	15														
	30														
	45														
2	60														
	75														
	90														
	105														
	120														
	135														
	150														
	165														
	180														
	195														
	210														
	225														
	240														
	255														
	270														
	285														
Version: 100															

**Face plate**

S0.F071/A10.E1L

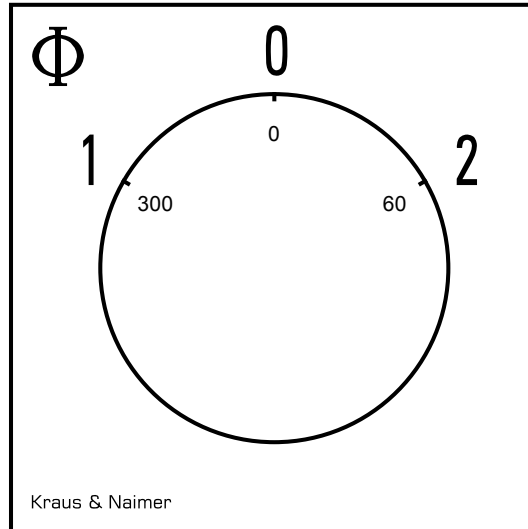

## HANDLES

**Designation:** S0C.G251  
**Handle colour:** "1" black

