



Sample image

Datasheet

Article number: 70012149
Designation: CG4.A240.FS2-V
Description: Schalter
Contact development: A240
Face plate engraving: F075
Type of mounting: FS2-V

Type Size: S00
Classification Contact: Rigid contact bridge
Classification Contact Mat: Silver
Classification Terminal: Screw terminal

IEC 60947-3 EN 60947-3, VDE 0660 Teil 107						
Rated insulation voltage U_i						
			Voltage (V) AC / DC			
			440 AC / DC			
Rated impulse withstand voltage U_{imp}						
Voltage (kV)	Overvoltage category	Pollution degree	Supply system		Function	
4	III	3	Valid for lines with grounded common neutral termination		switch	
Rated uninterrupted current I_u/Ith						
Current (A)	Ambient temperature (°C)		Peak temperature (°C) additional requirements			
10	55		60 Ambient temperature +55°C during 24 hours with peaks up to +60°C			
Conventional enclosed thermal current I_{th}						
Current (A)	Ambient temperature (°C)	Peak temperature (°C)	Additional requirements		No. of stages (from - to)	Mounting size
10	35	40	Ambient temperature +35°C during 24 hours with peaks up to +40°C		--	--
Rated operational current I_e						
Utilization category			Voltage (V)		Current (A)	
AC-15			110 - 110		2,50	
AC-15			220 - 240		2,50	
AC-15			380 - 440		1,50	
AC-20A			440		10	
AC-21A			440		10	
AC-22A			220 - 440		10	
Rated operational power						
Utilization category		Voltage (V)	No. of phases	No. of poles		Power (kW)
AC-6b		380 - 400	3	3		--
AC-6b		220 - 230	1	2		--
AC-2		220 - 240	3	3		2,50
AC-2		380 - 440	3	3		4,50
AC-3		220 - 240	3	3		1,50
AC-3		380 - 440	3	3		2,20
AC-3		110 - 120	1	2		0,30
AC-3		220 - 240	1	2		0,55
AC-3		380 - 440	1	2		0,75
AC-4		220 - 240	3	3		0,37
AC-4		380 - 440	3	3		0,55
AC-4		110 - 120	1	2		0,15
AC-4		220 - 240	1	2		0,25
AC-4		380 - 440	1	2		0,50
AC-23A		220 - 240	3	3		1,80
AC-23A		380 - 440	3	3		3
AC-23A		110 - 120	1	2		0,37
AC-23A		220 - 240	1	2		0,75
AC-23A		380 - 440	1	2		1,10
Max Fuse Rating IEC						
Fuse characteristic			No. of Fuses		Current (A)	
gG			1		10	
Tested AC and DC values						
Utilization category / Time constant		No. of contacts in series	Off or change-over switch	Voltage (V) AC / DC		Current (A)
DC-13		1	ON - OFF	24 DC		0,80
DC-13		1	ON - OFF	48 DC		0,50
DC-13		1	ON - OFF	60 DC		0,20
DC-13		2	ON - OFF	48 DC		0,80

Tested AC and DC values					
<i>Utilization category / Time constant</i>	<i>No. of contacts in series</i>	<i>Off or change-over switch</i>	<i>Voltage (V) AC / DC</i>		<i>Current (A)</i>
DC-13	2	ON - OFF	96	DC	0,50
DC-13	2	ON - OFF	120	DC	0,20
DC-13	3	ON - OFF	110	DC	1
DC-21A	1	ON - OFF	24	DC	10
DC-21A	1	ON - OFF	48	DC	6
DC-21A	1	ON - OFF	60	DC	5
DC-21A	1	ON - OFF	110	DC	4
DC-21A	1	ON - OFF	220	DC	0,80
DC-21A	2	ON - OFF	48	DC	10
DC-21A	2	ON - OFF	96	DC	6
DC-21A	2	ON - OFF	120	DC	5
DC-21A	2	ON - OFF	220	DC	4
DC-21A	2	ON - OFF	440	DC	0,80
DC-21A	3	ON - OFF	72	DC	10
DC-21A	3	ON - OFF	144	DC	6
DC-21A	3	ON - OFF	180	DC	5
DC-21A	3	ON - OFF	330	DC	4
DC-21A	3	ON - OFF	660	DC	0,80
DC-21A	4	ON - OFF	96	DC	10
DC-21A	4	ON - OFF	192	DC	6
DC-21A	4	ON - OFF	240	DC	5
DC-21A	4	ON - OFF	440	DC	4
DC-21A	5	ON - OFF	120	DC	10
DC-21A	5	ON - OFF	240	DC	6
DC-21A	5	ON - OFF	300	DC	5
DC-21A	5	ON - OFF	550	DC	4
DC-21A	6	ON - OFF	144	DC	10
DC-21A	6	ON - OFF	288	DC	6
DC-21A	6	ON - OFF	360	DC	5
DC-21A	6	ON - OFF	660	DC	4
DC-21A	8	ON - OFF	192	DC	10
DC-21A	8	ON - OFF	384	DC	6
DC-21A	8	ON - OFF	480	DC	5
DC-22A	1	ON - OFF	24	DC	8
DC-22A	1	ON - OFF	48	DC	5
DC-22A	1	ON - OFF	60	DC	4
DC-22A	1	ON - OFF	110	DC	1,50
DC-22A	1	ON - OFF	220	DC	0,30
DC-22A	2	ON - OFF	48	DC	8
DC-22A	2	ON - OFF	96	DC	5
DC-22A	2	ON - OFF	120	DC	4
DC-22A	2	ON - OFF	220	DC	1,50
DC-22A	2	ON - OFF	440	DC	0,30
DC-22A	3	ON - OFF	72	DC	8
DC-22A	3	ON - OFF	144	DC	5
DC-22A	3	ON - OFF	180	DC	4
DC-22A	3	ON - OFF	330	DC	1,50
DC-22A	3	ON - OFF	660	DC	0,30
DC-22A	4	ON - OFF	96	DC	8
DC-22A	4	ON - OFF	192	DC	5
DC-22A	4	ON - OFF	240	DC	4
DC-22A	4	ON - OFF	440	DC	1,50
DC-22A	5	ON - OFF	120	DC	8
DC-22A	5	ON - OFF	240	DC	5
DC-22A	5	ON - OFF	300	DC	4
DC-22A	5	ON - OFF	550	DC	1,50
DC-22A	6	ON - OFF	144	DC	8
DC-22A	6	ON - OFF	288	DC	5
DC-22A	6	ON - OFF	360	DC	4
DC-22A	6	ON - OFF	660	DC	1,50
DC-22A	8	ON - OFF	192	DC	8
DC-22A	8	ON - OFF	384	DC	5
DC-22A	8	ON - OFF	480	DC	4
DC-23A	1	ON - OFF	24	DC	7
DC-23A	1	ON - OFF	48	DC	4
DC-23A	1	ON - OFF	60	DC	3,50
DC-23A	1	ON - OFF	110	DC	1
DC-23A	1	ON - OFF	220	DC	0,20
DC-23A	2	ON - OFF	48	DC	7
DC-23A	2	ON - OFF	96	DC	4
DC-23A	2	ON - OFF	120	DC	3,50
DC-23A	2	ON - OFF	220	DC	1
DC-23A	2	ON - OFF	440	DC	0,20
DC-23A	3	ON - OFF	72	DC	7
DC-23A	3	ON - OFF	144	DC	4
DC-23A	3	ON - OFF	180	DC	3,50

Tested AC and DC values						
Utilization category / Time constant	No. of contacts in series	Off or change-over switch	Voltage (V) AC / DC		Current (A)	
DC-23A	3	ON - OFF	330	DC	1	
DC-23A	3	ON - OFF	660	DC	0,20	
DC-23A	4	ON - OFF	96	DC	7	
DC-23A	4	ON - OFF	192	DC	4	
DC-23A	4	ON - OFF	240	DC	3,50	
DC-23A	4	ON - OFF	440	DC	1	
DC-23A	5	ON - OFF	120	DC	7	
DC-23A	5	ON - OFF	240	DC	4	
DC-23A	5	ON - OFF	300	DC	3,50	
DC-23A	5	ON - OFF	550	DC	1	
DC-23A	6	ON - OFF	144	DC	7	
DC-23A	6	ON - OFF	288	DC	4	
DC-23A	6	ON - OFF	360	DC	3,50	
DC-23A	6	ON - OFF	660	DC	1	
DC-23A	8	ON - OFF	192	DC	7	
DC-23A	8	ON - OFF	384	DC	4	
DC-23A	8	ON - OFF	480	DC	3,50	
Rated conditional short-circuit current						
	Current (kA)	Text	cut-off current I _c (kA)		Durchlassenergie I ² t (kA ² s)	
	3	--	0,82		0,19	
Rated short-circuit making capacity I_{cm}						
						Current (A)
						200
UL60947-4-1 , UL508						
Nominal Voltage						
			Voltage (V) AC / DC			
			300 AC			
Rated insulation voltage U_i						
			Voltage (V) AC / DC			
			300 AC			
Rated thermal current						
	Current (A)	Ambient temperature (°C)		Additional Text		
	10	0 - 40		--		
Horsepower rating						
<i>Across-the-Line Motor Starting</i>			Voltage (V)	No. of phases	No. of poles	Power (HP)
DOL			110 - 120	1	2	0,33
DOL			220 - 240	1	2	0,75
DOL			277 - 277	1	2	0,75
DOL			110 - 120	3	3	0,75
DOL			220 - 240	3	3	1
Pilot duty rating code						
Duty Code						
A300						
Temp. rating of wire						
	Temperature rating (°C)		Current (A) Text			
	60 - 75		-- --			
General Use						
AC / DC	Voltage (V)	Current (A)	No. of phases	No. of poles	No. of contacts in series	
AC	120	10	1	1	1	
AC	300	10	1	2	1	
AC	300	10	3	3	1	
CSA						
Nominal Voltage						
			Voltage (V) AC / DC			
			300 AC			
Rated insulation voltage U_i						
			Voltage (V) AC / DC			
			300 AC			
Rated thermal current						
	Current (A)	Ambient temperature (°C)		Additional Text		
	10	0 - 40		--		
Horsepower rating						
<i>Across-the-Line Motor Starting</i>			Voltage (V)	No. of phases	No. of poles	Power (HP)
DOL			110 - 120	1	2	0,33
DOL			220 - 240	1	2	0,75
DOL			277 - 277	1	2	0,75
DOL			110 - 120	3	3	0,75
DOL			220 - 240	3	3	1
Pilot duty rating code						
Duty Code						
A300						
Temp. rating of wire						
	Temperature rating (°C)		Current (A) Text			
	75		-- --			
General Use						
AC / DC	Voltage (V)	Current (A)	No. of phases	No. of poles	No. of contacts in series	
AC	120	10	1	1	1	

General Use					
AC / DC	Voltage (V)	Current (A)	No. of phases	No. of poles	No. of contacts in series
AC	300	10	1	2	1
AC	300	10	3	3	1

MASTER DATA

Max. number of stages	number of stages	Modul
	8	FL

Switch Measures







Picture name	B	F	H	H1	H2	H3
	28	--	--	--	--	--

GENERAL TECHNICAL INFORMATION

Tightening torque of screws	tightening torque (Nm)	tightening torque (lb-in)
	0,40	3,50

Tested AC and DC values

Utilization category / Time constant	No. of contacts in series	Off or change-over switch	Voltage (V)	AC / DC	Current (A)
T≤1ms	1	ON - OFF	24	DC	10
T≤1ms	1	ON - OFF	48	DC	6
T≤1ms	1	ON - OFF	60	DC	2,50
T≤1ms	1	ON - OFF	110	DC	0,70
T≤1ms	1	ON - OFF	220	DC	0,30
T≤1ms	1	ON - OFF	440	DC	0,20
T≤1ms	2	ON - OFF	48	DC	10
T≤1ms	2	ON - OFF	95	DC	6
T≤1ms	2	ON - OFF	120	DC	2,50
T≤1ms	2	ON - OFF	220	DC	0,70
T≤1ms	2	ON - OFF	440	DC	0,30
T≤1ms	2	ON - OFF	660	DC	0,20
T≤1ms	3	ON - OFF	70	DC	10
T≤1ms	3	ON - OFF	140	DC	6
T≤1ms	3	ON - OFF	180	DC	2,50
T≤1ms	3	ON - OFF	330	DC	0,70
T≤1ms	3	ON - OFF	660	DC	0,30
T≤1ms	4	ON - OFF	95	DC	10
T≤1ms	4	ON - OFF	190	DC	6
T≤1ms	4	ON - OFF	240	DC	2,50
T≤1ms	4	ON - OFF	440	DC	0,70
T≤1ms	5	ON - OFF	120	DC	10
T≤1ms	5	ON - OFF	240	DC	6
T≤1ms	5	ON - OFF	300	DC	2,50
T≤1ms	5	ON - OFF	550	DC	0,70
T≤1ms	6	ON - OFF	145	DC	10
T≤1ms	6	ON - OFF	290	DC	6
T≤1ms	6	ON - OFF	360	DC	2,50
T≤1ms	6	ON - OFF	660	DC	0,70
T≤1ms	8	ON - OFF	190	DC	10
T≤1ms	8	ON - OFF	350	DC	6
T≤1ms	8	ON - OFF	450	DC	2,50
T=50ms	1	ON - OFF	24	DC	6
T=50ms	1	ON - OFF	30	DC	3
T=50ms	1	ON - OFF	48	DC	1
T=50ms	1	ON - OFF	60	DC	0,70
T=50ms	1	ON - OFF	110	DC	0,30
T=50ms	2	ON - OFF	48	DC	6
T=50ms	2	ON - OFF	60	DC	3
T=50ms	2	ON - OFF	95	DC	1
T=50ms	2	ON - OFF	120	DC	0,70
T=50ms	2	ON - OFF	220	DC	0,30
T=50ms	3	ON - OFF	70	DC	6
T=50ms	3	ON - OFF	90	DC	3
T=50ms	3	ON - OFF	140	DC	1
T=50ms	3	ON - OFF	180	DC	0,70
T=50ms	3	ON - OFF	330	DC	0,30
T=50ms	4	ON - OFF	95	DC	6
T=50ms	4	ON - OFF	120	DC	3
T=50ms	4	ON - OFF	190	DC	1
T=50ms	4	ON - OFF	240	DC	0,70
T=50ms	4	ON - OFF	440	DC	0,30
T=50ms	5	ON - OFF	120	DC	6
T=50ms	5	ON - OFF	150	DC	3
T=50ms	5	ON - OFF	240	DC	1
T=50ms	5	ON - OFF	300	DC	0,70
T=50ms	5	ON - OFF	550	DC	0,30
T=50ms	6	ON - OFF	145	DC	6

Tested AC and DC values									
Utilization category / Time constant	No. of contacts in series	Off or change-over switch	Voltage (V)		AC / DC	Current (A)			
T=50ms	6	ON - OFF	180		DC	3			
T=50ms	6	ON - OFF	290		DC	1			
T=50ms	6	ON - OFF	360		DC	0,70			
T=50ms	6	ON - OFF	660		DC	0,30			
T=50ms	8	ON - OFF	190		DC	6			
T=50ms	8	ON - OFF	240		DC	3			
T=50ms	8	ON - OFF	350		DC	1			
T=50ms	8	ON - OFF	450		DC	0,70			
Stripping length									
Length (mm) --									
6 STRIPPINGLENGTH									
Minimal ratings (voltage/current)									
Voltage (V)	Current (mA)	Environment conditions		Environment conditions 2		Environment conditions 3			
20	5	Ambient air must be free of particular contamination with sulfur and/or sulfurous components such as H2S etc.		In case extraordinary contamination with dust is expected an adequate dust protection is required.		--			
Rated short-time withstand current Icw									
Time (s)									
1									
Current (A) 90									
Size of conductor									
composition of conductor	Min. / Max. value	No. of conductor per terminal		Cross section (mm ²) or (AWG/kcmil)		Material of the wire			
solid wire	Min.	1		0.5mm ²		Copper			
solid wire	Min.	2		0.5mm ²		Copper			
flexible wire	Min.	1		0.75mm ²		Copper			
flexible wire	Min.	2		0.75mm ²		Copper			
flexible wire	Max.	2		AWG 16		Copper			
flexible wire	Max.	2		1.5mm ²		Copper			
Single-core or stranded wire	Max.	2		AWG 14		Copper			
Single-core or stranded wire	Max.	2		1.5mm ²		Copper			
flexible wire with ferrule according to DIN 46228	Max.	2		1mm ²		Copper			
flexible wire with ferrule according to DIN 46228	Min.	1		0.5mm ²		Copper			
flexible wire with ferrule according to DIN 46228	Min.	2		0.5mm ²		Copper			
Approbations									
Specification						Marking			
EAC									
CE marking									
UK Directives									
IEC 60947-3; EN 60947-3; VDE 0660 Teil107						IEC 60947-3 EN 60947-3			
UL 60947-4-1; CSA C22.2 No. 60947-4-1									
CSA C.22.2 No.14									
GB/T14048.3									
Power loss per pole									
Power (W) 0,40									
Mechanical life									
No. of operations	Ambient temperature (°C)		Number of stages		Limitations				
1000000	-5 - 55				Valid for manual operation. Valid for switches without optional extras. The value refers to the mechanics of the device, for lifetime of the electrical contacts please refer to "electrical life values".				
150000	-25 - 55				Valid for manual operation. Valid for switches without optional extras. The value refers to the mechanics of the device, for lifetime of the electrical contacts please refer to "electrical life values".				
Electrical life (B10-Value)									
Utilization category	cos(φ)	Time constant (ms)	Voltage (V)	Current (A)	No. of operations	number of series contacts	AC/DC	No. of phases	No. of poles
--	0,59	--	122	10	50000	1	AC	1	1
--	0,59	--	220	5	150000	1	AC	1	1
--	0,59	--	220	10	25000	1	AC	1	1
--	0,95	--	220	10	25000	1	AC	1	1
--	0,65	--	380	5	100000	1	AC	1	1
AC-3	--	--	440	7	150000	1	AC	3	3

Electrical life (B10-Value)									
Utilization category	cos(φ)	Time constant (ms)	Voltage (V)	Current (A)	No. of operations	number of series contacts	AC/DC	No. of phases	No. of poles
AC-23	--	--	440	10	25000	1	AC	3	3
--	--	1	24	10	140000	1	DC	1	1
--	--	1	48	6	50000	1	DC	1	1
--	--	1	60	2,50	200000	1	DC	1	1
--	--	1	110	0,70	100000	1	DC	1	1
--	--	1	220	0,30	200000	1	DC	1	1
--	--	48	24	0,25	400000	1	DC	1	1
--	--	50	24	0,50	100000	1	DC	1	1
--	--	50	24	1	50000	1	DC	1	1
--	--	50	24	6	10000	1	DC	1	1
--	--	50	30	3	20000	1	DC	1	1
--	--	50	48	1	50000	1	DC	1	1
--	--	50	110	0,30	75000	1	DC	1	1
--	--	50	110	0,50	50000	1	DC	1	1
--	--	53	110	0,10	200000	1	DC	1	1
--	--	55	110	1	25000	1	DC	1	1

Recommended screw driver

Type of screw driver	Value
Cross Screwdriver	PH1
Flat blade	0,6x3,5

Degree of protection

IP - Code switch terminal	
IP20	

Conditions during transport and storing

Minimum temperature (°C)	Maximum temperature (°C)	additional requirements
-40	85	In case of temperatures below -5°C no shock load permissible

Shock / Vibration

Type of oscillation	Values
Resistance to shock	min. 5g, 30ms

General Information

Text

- Do not lubricate or treat contacts.
- Switches may only be mounted, connected and set into operation by qualified persons according to the accepted rules of technology.
- Use copper wire only. Do not coat the wire end with tin.
- Terminals with factory fitted jumper links are tightened during production. Take care during installation to ensure factory fitted links are not lost by undoing both sides of linked terminals. After wiring, all terminal screws must be tightened to recommended torque specifications.
- After installation of the switches the spacings between the terminals must be sufficient to fulfill the requirement of the applicable standards.

Creepage distance

	Distance (mm)
	6,35

Clearance

	Distance (mm)
	6,35

Distance of stages

	Distance (mm)
	12

Operating temperature

Min. Temperature [°C]	Max. Temperature [°C]
-25	60

Waste Electrical & Electronic Equipment (WEEE)

Picture name	Description
	

Do not throw in the trash as care must be taken to ensure environmentally sound disposal and recycling. Please either use an environmentally friendly waste disposal company; return to the supplier for disposal; or return direct to the manufacturer, Kraus & Naimer. You can find local Kraus & Naimer offices at www.krausnaimer.com

Proposition 65

Picture name	Description
	WARNING: This product can expose you to chemicals including nickel and lead, which is known to the State of California to cause cancer. For more information go to www.P65Warnings.ca.gov .

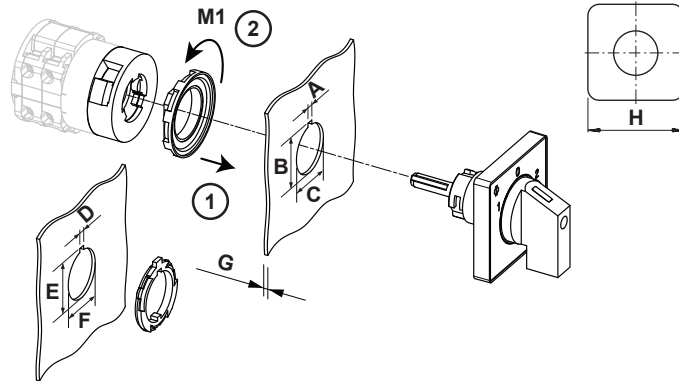
Mounting-FS2-V

IP - Code front side		IP66, IP67, IP69k
Stages		1,00 - 8,00
A	H	1,70 mm
A+_tol.	H	0,20 mm
A-_tol.	H	0,00 mm
B	H	17,90 mm
B+_tol.	H	0,20 mm
B-_tol.	H	0,00 mm
C	Ø	16,20 mm
C+_tol.	Ø	0,20 mm
C-_tol.	Ø	0,00 mm
D	H	3,20 mm
D+_tol.	H	0,20 mm
D-_tol.	H	0,00 mm
E	H	24,10 mm
E+_tol.	H	0,40 mm
E-_tol.	H	0,00 mm
F	Ø	22,30 mm
F+_tol.	Ø	0,40 mm
F-_tol.	Ø	0,00 mm
G	H	<= 5,00 mm
H	H	30,00 mm
M1	↺	0,70 Nm

Wiring diagram

CG4.A240.FS2-V

 Kraus & Naimer

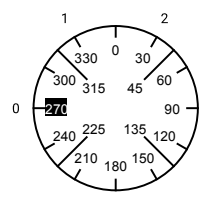
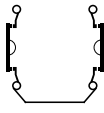
		CG4		A240		Page 1 of 1							
Face Plate													
		1	3	5	7	9	11	13	15	17	19	21	23
													
Switching Angle <input type="text" value="60"/> Total switching Angle <input type="text" value="120"/>		2	4	6	8	10	12	14	16	18	20	22	24
0	270												
	285												
	300												
	315												
1	330												
	345												
	0												
	15												
2	30												
	45												
	60												
	75												
	90												
	105												
	120												
	135												
	150												
	165												
	180												
	195												
	210												
	225												
	240												
	255												

Version: 77

Face plate

S00.F075/A10.E1

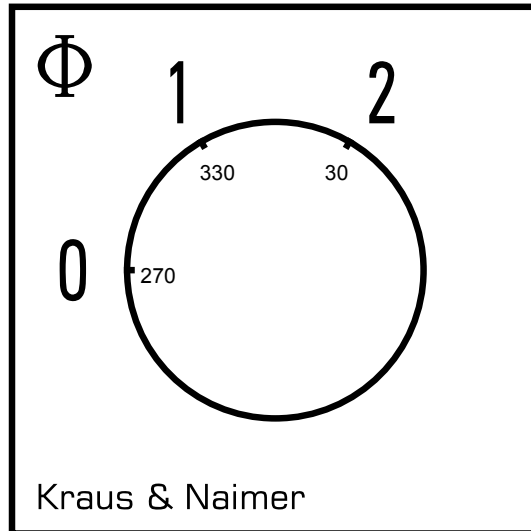

HANDLES

Designation: S00.G251
Handle colour: "1" black

