



Sample image

Datasheet

Article number: 70007570
Designation: CA4.A291.FS2
Description: Schalter
Contact development: A291
Face plate engraving: F056
Type of mounting: FS2

Type Size: S00
Classification Contact: Rigid contact bridge
Classification Contact Mat: Silver
Classification Terminal: Screw terminal

IEC 60947-3 EN 60947-3, VDE 0660 Teil 107						
Rated insulation voltage Ui						
		Voltage (V) AC / DC				
		440 AC / DC				
Rated impulse withstand voltage Uimp						
Voltage (kV)	Overvoltage category	Pollution degree	Supply system	Function		
4 III		3	Valid for lines with grounded common neutral termination	switch		
Rated uninterrupted current Iu/Ith						
Current (A)	Ambient temperature (°C)	Peak temperature (°C)	additional requirements			
10	55	60	Ambient temperature +55°C during 24 hours with peaks up to +60°C			
Conventional enclosed thermal current Ithe						
Current (A)	Ambient temperature (°C)	Peak temperature (°C)	Additional requirements	No. of stages (from - to)	Mounting	Mounting size
10	35	40	Ambient temperature +35°C during 24 hours with peaks up to +40°C	--	--	--
Rated operational current Ie						
Utilization category			Voltage (V)	Current (A)		
AC-15			220 - 240	2,50		
AC-15			380 - 440	1,50		
AC-20A			440	10		
AC-21A			440	10		
AC-22A			220 - 440	10		
Rated operational power						
Utilization category	Voltage (V)	No. of phases	No. of poles	Power (kW)		
AC-2	220 - 240	3	3	2,50		
AC-2	380 - 440	3	3	4,50		
AC-3	220 - 240	3	3	1,50		
AC-3	380 - 440	3	3	2,20		
AC-3	110 - 120	1	2	0,30		
AC-3	220 - 240	1	2	0,55		
AC-3	380 - 440	1	2	0,75		
AC-4	220 - 240	3	3	0,37		
AC-4	380 - 440	3	3	0,55		
AC-4	110 - 120	1	2	0,15		
AC-4	220 - 240	1	2	0,25		
AC-4	380 - 440	1	2	0,50		
AC-23A	220 - 240	3	3	1,80		
AC-23A	380 - 440	3	3	3		
AC-23A	110 - 120	1	2	0,37		
AC-23A	220 - 240	1	2	0,75		
AC-23A	380 - 440	1	2	1,10		
Max Fuse Rating IEC						
Fuse characteristic			No. of Fuses	Current (A)		
gG			1	10		
Tested AC and DC values						
Utilization category / Time constant	No. of contacts in series	Off or change-over switch	Voltage (V) AC / DC	Current (A)		
DC-13	1	ON - OFF	24 DC	0,80		
DC-13	1	ON - OFF	48 DC	0,50		
DC-13	1	ON - OFF	60 DC	0,20		
DC-13	2	ON - OFF	48 DC	0,80		
DC-13	2	ON - OFF	96 DC	0,50		
DC-13	2	ON - OFF	120 DC	0,20		
DC-13	3	ON - OFF	110 DC	1		

Tested AC and DC values					
Utilization category / Time constant	No. of contacts in series	Off or change-over switch	Voltage (V)	AC / DC	Current (A)
DC-21A	1	ON - OFF	24	DC	10
DC-21A	1	ON - OFF	48	DC	6
DC-21A	1	ON - OFF	60	DC	5
DC-21A	1	ON - OFF	110	DC	4
DC-21A	1	ON - OFF	220	DC	0,80
DC-21A	2	ON - OFF	48	DC	10
DC-21A	2	ON - OFF	96	DC	6
DC-21A	2	ON - OFF	120	DC	5
DC-21A	2	ON - OFF	220	DC	4
DC-21A	2	ON - OFF	440	DC	0,80
DC-21A	3	ON - OFF	72	DC	10
DC-21A	3	ON - OFF	144	DC	6
DC-21A	3	ON - OFF	180	DC	5
DC-21A	3	ON - OFF	330	DC	4
DC-21A	3	ON - OFF	660	DC	0,80
DC-21A	4	ON - OFF	96	DC	10
DC-21A	4	ON - OFF	192	DC	6
DC-21A	4	ON - OFF	240	DC	5
DC-21A	4	ON - OFF	440	DC	4
DC-21A	5	ON - OFF	120	DC	10
DC-21A	5	ON - OFF	240	DC	6
DC-21A	5	ON - OFF	300	DC	5
DC-21A	5	ON - OFF	550	DC	4
DC-21A	6	ON - OFF	144	DC	10
DC-21A	6	ON - OFF	288	DC	6
DC-21A	6	ON - OFF	360	DC	5
DC-21A	6	ON - OFF	660	DC	4
DC-21A	8	ON - OFF	192	DC	10
DC-21A	8	ON - OFF	384	DC	6
DC-21A	8	ON - OFF	480	DC	5
DC-22A	1	ON - OFF	24	DC	8
DC-22A	1	ON - OFF	48	DC	5
DC-22A	1	ON - OFF	60	DC	4
DC-22A	1	ON - OFF	110	DC	1,50
DC-22A	1	ON - OFF	220	DC	0,30
DC-22A	2	ON - OFF	48	DC	8
DC-22A	2	ON - OFF	96	DC	5
DC-22A	2	ON - OFF	120	DC	4
DC-22A	2	ON - OFF	220	DC	1,50
DC-22A	2	ON - OFF	440	DC	0,30
DC-22A	3	ON - OFF	72	DC	8
DC-22A	3	ON - OFF	144	DC	5
DC-22A	3	ON - OFF	180	DC	4
DC-22A	3	ON - OFF	330	DC	1,50
DC-22A	3	ON - OFF	660	DC	0,30
DC-22A	4	ON - OFF	96	DC	8
DC-22A	4	ON - OFF	192	DC	5
DC-22A	4	ON - OFF	240	DC	4
DC-22A	4	ON - OFF	440	DC	1,50
DC-22A	5	ON - OFF	120	DC	8
DC-22A	5	ON - OFF	240	DC	5
DC-22A	5	ON - OFF	300	DC	4
DC-22A	5	ON - OFF	550	DC	1,50
DC-22A	6	ON - OFF	144	DC	8
DC-22A	6	ON - OFF	288	DC	5
DC-22A	6	ON - OFF	360	DC	4
DC-22A	6	ON - OFF	660	DC	1,50
DC-22A	8	ON - OFF	192	DC	8
DC-22A	8	ON - OFF	384	DC	5
DC-22A	8	ON - OFF	480	DC	4
DC-23A	1	ON - OFF	24	DC	7
DC-23A	1	ON - OFF	48	DC	4
DC-23A	1	ON - OFF	60	DC	3,50
DC-23A	1	ON - OFF	110	DC	1
DC-23A	1	ON - OFF	220	DC	0,20
DC-23A	2	ON - OFF	48	DC	7
DC-23A	2	ON - OFF	96	DC	4
DC-23A	2	ON - OFF	120	DC	3,50
DC-23A	2	ON - OFF	220	DC	1
DC-23A	2	ON - OFF	440	DC	0,20
DC-23A	3	ON - OFF	72	DC	7
DC-23A	3	ON - OFF	144	DC	4
DC-23A	3	ON - OFF	180	DC	3,50
DC-23A	3	ON - OFF	330	DC	1
DC-23A	3	ON - OFF	660	DC	0,20
DC-23A	4	ON - OFF	96	DC	7

Tested AC and DC values						
Utilization category / Time constant	No. of contacts in series	Off or change-over switch	Voltage (V) AC / DC		Current (A)	
DC-23A	4	ON - OFF	192	DC		4
DC-23A	4	ON - OFF	240	DC		3,50
DC-23A	4	ON - OFF	440	DC		1
DC-23A	5	ON - OFF	120	DC		7
DC-23A	5	ON - OFF	240	DC		4
DC-23A	5	ON - OFF	300	DC		3,50
DC-23A	5	ON - OFF	550	DC		1
DC-23A	6	ON - OFF	144	DC		7
DC-23A	6	ON - OFF	288	DC		4
DC-23A	6	ON - OFF	360	DC		3,50
DC-23A	6	ON - OFF	660	DC		1
DC-23A	8	ON - OFF	192	DC		7
DC-23A	8	ON - OFF	384	DC		4
DC-23A	8	ON - OFF	480	DC		3,50
Rated conditional short-circuit current						
	Current (kA)	Text	cut-off current I _c (kA)		Durchlassenergie I ² t (kA ² s)	
	3	--	0,82		0,19	
Rated breaking capacity						
	Voltage (V)		Current (A)	Utilization category / UL (DOL)		
	220 - 240		50	--		
	380 - 440		50	--		
Rated short-circuit making capacity I_{cm}						
	Current (A)					
	200					
UL60947-4-1, UL508						
Nominal Voltage						
	Voltage (V) AC / DC					
	300 AC					
Rated insulation voltage U_i						
	Voltage (V) AC / DC					
	300 AC					
Rated thermal current						
	Current (A)	Ambient temperature (°C)		Additional Text		
	10	0 - 40		--		
Horsepower rating						
<i>Across-the-Line Motor Starting</i>			Voltage (V)	No. of phases	No. of poles	Power (HP)
DOL			110 - 120	1	2	0,33
DOL			220 - 240	1	2	0,75
DOL			277 - 277	1	2	0,75
DOL			110 - 120	3	3	0,75
DOL			220 - 240	3	3	1
Pilot duty rating code						
Duty Code						
A300						
Temp. rating of wire						
	Temperature rating (°C)		Current (A)	Text		
	60 - 75		--	--		
General Use						
AC / DC	Voltage (V)	Current (A)	No. of phases	No. of poles	No. of contacts in series	
AC	120	10	1	1	1	
AC	277	10	1	2	1	
AC	277	10	3	3	1	
CSA						
Nominal Voltage						
	Voltage (V) AC / DC					
	300 AC					
Rated insulation voltage U_i						
	Voltage (V) AC / DC					
	300 AC					
Rated thermal current						
	Current (A)	Ambient temperature (°C)		Additional Text		
	10	0 - 40		--		
Horsepower rating						
<i>Across-the-Line Motor Starting</i>			Voltage (V)	No. of phases	No. of poles	Power (HP)
DOL			110 - 120	1	2	0,33
DOL			220 - 240	1	2	0,75
DOL			277 - 277	1	2	0,75
DOL			110 - 120	3	3	0,75
DOL			220 - 240	3	3	1
Pilot duty rating code						
Duty Code						
A300						
Temp. rating of wire						
	Temperature rating (°C)		Current (A)	Text		
	75		--	only		

General Use					
AC / DC	Voltage (V)	Current (A)	No. of phases	No. of poles	No. of contacts in series
AC	120	10	1	1	1
AC	277	10	1	2	1

MASTER DATA

Max. number of stages	number of stages	Modul
	9	FL

Switch Measures

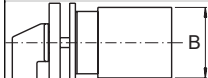





Picture name	B	F	H	H1	H2	H3
	29,50	--	--	--	--	--

GENERAL TECHNICAL INFORMATION

Tightening torque of screws	tightening torque (Nm)	tightening torque (lb-in)
	0,40	3,50

Tested AC and DC values

Utilization category / Time constant	No. of contacts in series	Off or change-over switch	Voltage (V)	AC / DC	Current (A)
T≤1ms	1	ON - OFF	24	DC	10
T≤1ms	1	ON - OFF	48	DC	6
T≤1ms	1	ON - OFF	60	DC	2,50
T≤1ms	1	ON - OFF	110	DC	0,70
T≤1ms	1	ON - OFF	220	DC	0,30
T≤1ms	1	ON - OFF	440	DC	0,20
T≤1ms	2	ON - OFF	48	DC	10
T≤1ms	2	ON - OFF	95	DC	6
T≤1ms	2	ON - OFF	120	DC	2,50
T≤1ms	2	ON - OFF	220	DC	0,70
T≤1ms	2	ON - OFF	440	DC	0,30
T≤1ms	2	ON - OFF	660	DC	0,20
T≤1ms	3	ON - OFF	70	DC	10
T≤1ms	3	ON - OFF	140	DC	6
T≤1ms	3	ON - OFF	180	DC	2,50
T≤1ms	3	ON - OFF	330	DC	0,70
T≤1ms	3	ON - OFF	660	DC	0,30
T≤1ms	4	ON - OFF	95	DC	10
T≤1ms	4	ON - OFF	190	DC	6
T≤1ms	4	ON - OFF	240	DC	2,50
T≤1ms	4	ON - OFF	440	DC	0,70
T≤1ms	5	ON - OFF	120	DC	10
T≤1ms	5	ON - OFF	240	DC	6
T≤1ms	5	ON - OFF	300	DC	2,50
T≤1ms	5	ON - OFF	550	DC	0,70
T≤1ms	6	ON - OFF	145	DC	10
T≤1ms	6	ON - OFF	290	DC	6
T≤1ms	6	ON - OFF	360	DC	2,50
T≤1ms	6	ON - OFF	660	DC	0,70
T≤1ms	8	ON - OFF	190	DC	10
T≤1ms	8	ON - OFF	350	DC	6
T≤1ms	8	ON - OFF	450	DC	2,50
T=50ms	1	ON - OFF	24	DC	6
T=50ms	1	ON - OFF	30	DC	3
T=50ms	1	ON - OFF	48	DC	1
T=50ms	1	ON - OFF	60	DC	0,70
T=50ms	1	ON - OFF	110	DC	0,30
T=50ms	2	ON - OFF	48	DC	6
T=50ms	2	ON - OFF	60	DC	3
T=50ms	2	ON - OFF	95	DC	1
T=50ms	2	ON - OFF	120	DC	0,70
T=50ms	2	ON - OFF	220	DC	0,30
T=50ms	3	ON - OFF	70	DC	6
T=50ms	3	ON - OFF	90	DC	3
T=50ms	3	ON - OFF	140	DC	1
T=50ms	3	ON - OFF	180	DC	0,70
T=50ms	3	ON - OFF	330	DC	0,30
T=50ms	4	ON - OFF	95	DC	6
T=50ms	4	ON - OFF	120	DC	3
T=50ms	4	ON - OFF	190	DC	1
T=50ms	4	ON - OFF	240	DC	0,70
T=50ms	4	ON - OFF	440	DC	0,30
T=50ms	5	ON - OFF	120	DC	6
T=50ms	5	ON - OFF	150	DC	3
T=50ms	5	ON - OFF	240	DC	1
T=50ms	5	ON - OFF	300	DC	0,70
T=50ms	5	ON - OFF	550	DC	0,30
T=50ms	6	ON - OFF	145	DC	6

Tested AC and DC values									
Utilization category / Time constant	No. of contacts in series	Off or change-over switch	Voltage (V) AC / DC		Current (A)				
T=50ms	6	ON - OFF	180 DC		3				
T=50ms	6	ON - OFF	290 DC		1				
T=50ms	6	ON - OFF	360 DC		0,70				
T=50ms	6	ON - OFF	660 DC		0,30				
T=50ms	8	ON - OFF	190 DC		6				
T=50ms	8	ON - OFF	240 DC		3				
T=50ms	8	ON - OFF	350 DC		1				
T=50ms	8	ON - OFF	450 DC		0,70				
Stripping length									
Length (mm) --									
6 STRIPPINGLENGTH									
Minimal ratings (voltage/current)									
Voltage (V)	Current (mA)	Environment conditions		Environment conditions 2	Environment conditions 3				
20	5	Ambient air must be free of particular contamination with sulfur and/or sulfurous components such as H2S etc.		In case extraordinary contamination with dust is expected an adequate dust protection is required.	--				
Rated short-time withstand current Icw									
Time (s)									
1									
Current (A) 60									
Size of conductor									
composition of conductor	Min. / Max. value	No. of conductor per terminal		Cross section (mm ²) or (AWG/kcmil)	Material of the wire				
solid wire	Min.	1		0.5mm ²	Copper				
solid wire	Min.	2		0.5mm ²	Copper				
flexible wire	Min.	1		0.75mm ²	Copper				
flexible wire	Min.	2		0.75mm ²	Copper				
flexible wire	Max.	2		AWG 16	Copper				
flexible wire	Max.	2		1.5mm ²	Copper				
Single-core or stranded wire	Max.	2		AWG 14	Copper				
Single-core or stranded wire	Max.	2		1.5mm ²	Copper				
flexible wire with ferrule according to DIN 46228	Max.	2		1mm ²	Copper				
flexible wire with ferrule according to DIN 46228	Min.	1		0.5mm ²	Copper				
flexible wire with ferrule according to DIN 46228	Min.	2		0.5mm ²	Copper				
Approbations									
Specification								Marking	
EAC									
CE marking									
UK Directives									
IEC 60947-3; EN 60947-3; VDE 0660 Teil107								IEC 60947-3 EN 60947-3	
UL 60947-4-1; CSA C22.2 No. 60947-4-1									
CSA C.22.2 No.14									
Russian Maritime Register of Shipping									
Power loss per pole									
Power (W) 0,40									
Mechanical life									
No. of operations	Ambient temperature (°C)		Number of stages		Limitations				
1000000	-5 - 55				Valid for manual operation. Valid for switches without optional extras. The value refers to the mechanics of the device, for lifetime of the electrical contacts please refer to "electrical life -- values".				
Electrical life (B10-Value)									
Utilization category	cos(φ)	Time constant (ms)	Voltage (V)	Current (A)	No. of operations	number of series contacts AC/DC		No. of phases	No. of poles
--	0,59	--	122	10	50000	1	AC	1	1
--	0,59	--	220	5	150000	1	AC	1	1
--	0,59	--	220	10	25000	1	AC	1	1
--	0,95	--	220	10	25000	1	AC	1	1
--	0,65	--	380	5	100000	1	AC	1	1
AC-3	--	--	440	7	150000	1	AC	3	3
AC-23	--	--	440	10	25000	1	AC	3	3
--	--	1	24	10	140000	1	DC	1	1
--	--	1	48	6	50000	1	DC	1	1
--	--	1	60	2,50	200000	1	DC	1	1

Electrical life (B10-Value)									
Utilization category	cos(φ)	Time constant (ms)	Voltage (V)	Current (A)	No. of operations	number of series contacts	AC/DC	No. of phases	No. of poles
--	--	1	110	0,70	100000	1 DC		1	1
--	--	1	220	0,30	200000	1 DC		1	1
--	--	1	440	0,20	200000	1 DC		1	1
--	--	48	24	0,25	400000	1 DC		1	1
--	--	50	24	0,50	100000	1 DC		1	1
--	--	50	24	1	50000	1 DC		1	1
--	--	50	24	6	10000	1 DC		1	1
--	--	50	30	3	20000	1 DC		1	1
--	--	50	48	1	50000	1 DC		1	1
--	--	50	60	0,70	70000	1 DC		1	1
--	--	50	110	0,30	75000	1 DC		1	1
--	--	50	110	0,50	50000	1 DC		1	1
--	--	53	110	0,10	200000	1 DC		1	1
--	--	55	110	1	25000	1 DC		1	1
--	--	100	110	0,50	30000	1 DC		1	1
--	--	100	110	1	15000	1 DC		1	1

Recommended screw driver

Type of screw driver	Value
Cross Screwdriver	PH1
Flat blade	0,6x3,5

Degree of protection

IP - Code switch terminal	
IP20	

Conditions during transport and storing

Minimum temperature (°C)	Maximum temperature (°C)	additional requirements
-40	85	In case of temperatures below -5°C no shock load permissible

Shock / Vibration

Type of oscillation	Values
Resistance to vibration	Min. 4g, 2-100Hz, 1,6mm
Resistance to shock	Min. 5g, 6ms

General Information

Text

- DC switching capacity applies to ON/OFF switches.
- Do not lubricate or treat contacts.
- Switches may only be mounted, connected and set into operation by qualified persons according to the accepted rules of technology.
- Use copper wire only. Do not coat the wire end with tin.
- Terminals with factory fitted jumper links are tightened during production. Take care during installation to ensure factory fitted links are not lost by undoing both sides of linked terminals. After wiring, all terminal screws must be tightened to recommended torque specifications.
- After installation of the switches the spacings between the terminals must be sufficient to fulfill the requirement of the applicable standards.

Creepage distance

	Distance (mm)
	6,35

Clearance

	Distance (mm)
	6,35

Distance of stages

	Distance (mm)
	8

Operating temperature

Min. Temperature [°C]	Max. Temperature [°C]
-25	60

Waste Electrical & Electronic Equipment (WEEE)

Picture name	Description
	

Do not throw in the trash as care must be taken to ensure environmentally sound disposal and recycling. Please either use an environmentally friendly waste disposal company; return to the supplier for disposal; or return direct to the manufacturer, Kraus & Naimer. You can find local Kraus & Naimer offices at www.krausnaimer.com

Proposition 65

Picture name	Description
	WARNING: This product can expose you to chemicals including nickel and lead, which is known to the State of California to cause cancer. For more information go to www.P65Warnings.ca.gov .

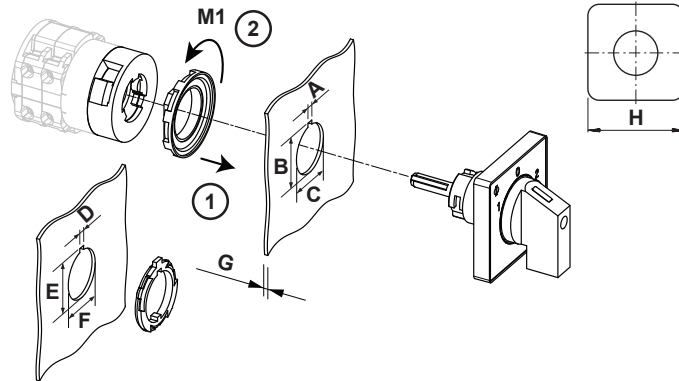
Mounting-FS2

IP - Code front side		IP66, IP67, IP69k
Stages		1,00 - 12,00
A	H	1,70 mm
A+_tol.	H	0,20 mm
A-_tol.	H	0,00 mm
B	H	17,90 mm
B+_tol.	H	0,20 mm
B-_tol.	H	0,00 mm
C	Ø	16,20 mm
C+_tol.	Ø	0,20 mm
C-_tol.	Ø	0,00 mm
D	H	3,20 mm
D+_tol.	H	0,20 mm
D-_tol.	H	0,00 mm
E	H	24,10 mm
E+_tol.	H	0,40 mm
E-_tol.	H	0,00 mm
F	Ø	22,30 mm
F+_tol.	Ø	0,40 mm
F-_tol.	Ø	0,00 mm
G	H	<= 5,00 mm
H	H	30,00 mm
M1	↺	0,70 Nm

Wiring diagram

CA4.A291.FS2

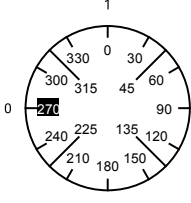
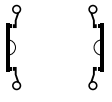
 Kraus & Naimer		CA4		A291		Page 1 of 1							
		Face Plate											
		1	3	5	7	9	11	13	15	17	19	21	23
													
Switching Angle <input type="text" value="90"/> Total switching Angle <input type="text" value="90"/>		2	4	6	8	10	12	14	16	18	20	22	24
0		270											
		285											
		300											
		315											
		330	■	■									
		345											
1		0	■	■									
		15											
		30											
		45											
		60											
		75											
		90											
		105											
		120											
		135											
		150											
		165											
		180											
		195											
		210											
		225											
		240											
		255											

Version: 95

Face plate

S00.F056/A10.E1

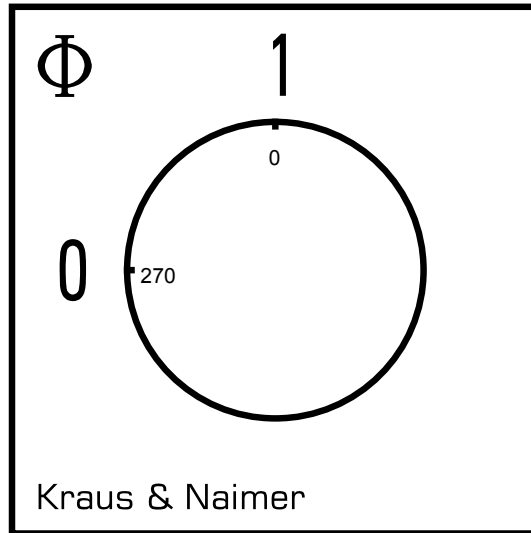

HANDLES

Designation: S00.G251
Handle colour: "1" black

